

V4.7

# VU-NET

## User Guide

A guide to Martin Audio's VU-NET 2.2  
control and monitoring software





## Contents

Version History .....	3
Installation .....	3
System requirements .....	3
Vu-Net .....	4
Introduction.....	4
Menus.....	4
Window components .....	5
Working Offline .....	20
Device Discovery .....	31
MLA/MLD & Compact Arrays .....	61
MLX & DSX Arrays.....	83
MLA Mini .....	89
DD12.....	100
PSX.....	117
CDD Live .....	136
Merlin .....	158
U-Hub .....	174
DX4.0 .....	177
Ganging .....	197
iK81 & iK42 .....	221
Loading Multicellular Presets .....	299
Master Overview .....	305
Show Mode .....	310
Firmware Updates.....	313
MLA/MLD Conversion Tool .....	319



## Version History

Manual Version 4.7

Vu-Net Version: 2.2.0

### Installation

MLA and MLA Compact touring system owners will have a Tablet PC as part of their system package which will be pre-loaded with all necessary software including the latest version of Vu-Net. For owners of Installed systems, MLA Mini, DD12, PSX or CDD Live systems, XE Series monitors, Wavefront Precision, IKON amplifiers or DX4.0 Processors, Vu-Net can be downloaded from the Martin Audio website at <https://martin-audio.com/software/software/> and installed on a PC of your choice.

### System requirements

Vu-Net requires a Windows PC running either Windows 7, Windows 8 or Windows 10; no other operating systems are supported. We would recommend a 64 bit i7 processor running at 2.6GHz minimum with a minimum of 8GB of RAM. Display resolution must be a minimum of 1366x768 and no greater than 1920x1080.

File sizes are not particularly huge so a high-capacity Hard Drive is not necessary but an SSD drive will be faster and more reliable. It may be useful for a portable system to use a tablet-style PC which can be connected wirelessly to the network to allow freedom to listen to the system in all points in the venue and make any adjustments in real time.

Users have reported that Vu-Net works perfectly well on an Apple Mac using Bootcamp or under a virtual platform such as VM Ware Fusion or Parallels, (these options still require a copy of Windows 7, 8 or 10 to be installed) however this is *not* supported by Martin Audio.

## Vu-Net

### Introduction

Vu-Net is the application used to connect to a U-Net enabled device such as the Multicellular family of products, the DD12, PSX, CDD Live, iKon amplifiers or Merlin processor. Connection to the cabinets and processors is achieved using the U-Net network protocol. Vu-Net is used to monitor and control the system, EQ optimisations for multicellular arrays are uploaded from the program and cabinet firmware is checked and updated. Vu-Net is supplied ready installed on the Panasonic tablet PC supplied with MLA and MLA Compact systems. It is an optional method of control for full use of MLA Mini, DD12, PSX and CDD Live.

### Menus

Before we look at the design process that is used with a system it is worth taking a look at the file structure which we will refer back to throughout the chapter. When you run Vu-Net you will see the following Window; -

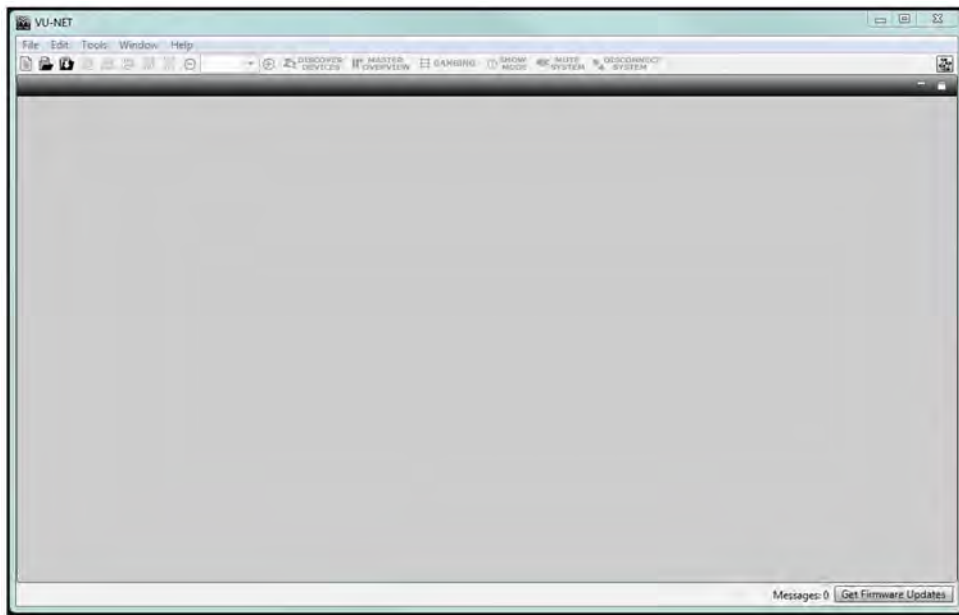

This is a blank screen with only 'New Project' and 'Open Project' active prompting you to start by using one or the other. Start by clicking on 'New Vu-Net project. You will see the following window; -

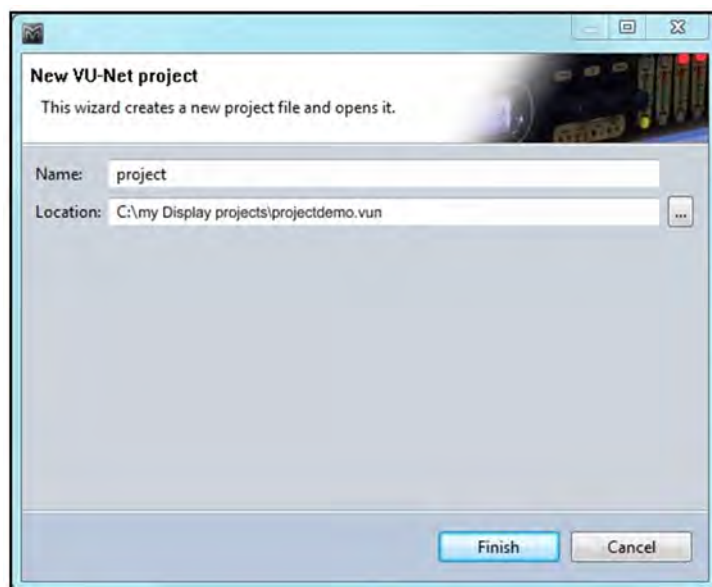

Type a name for your project and select a suitable file location. As with Display 2.1 we would recommend creating one folder for all related files for a given event.

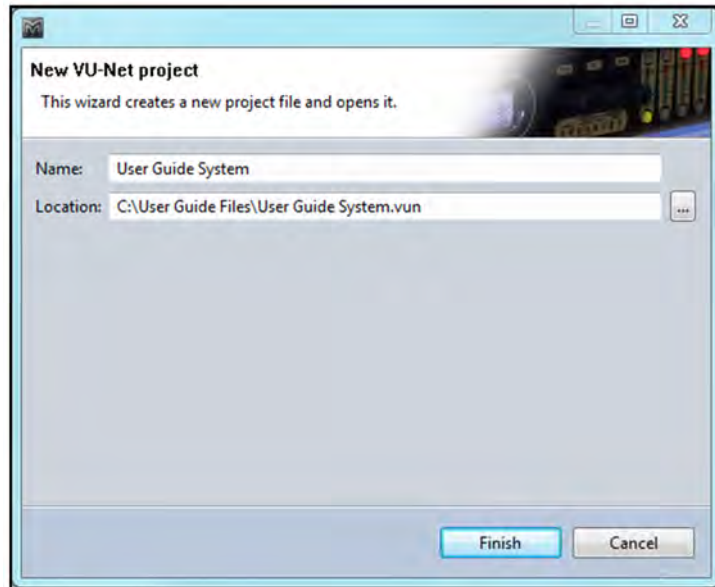

Once you have selected an appropriate name and file location click finish and a new project will be created; -

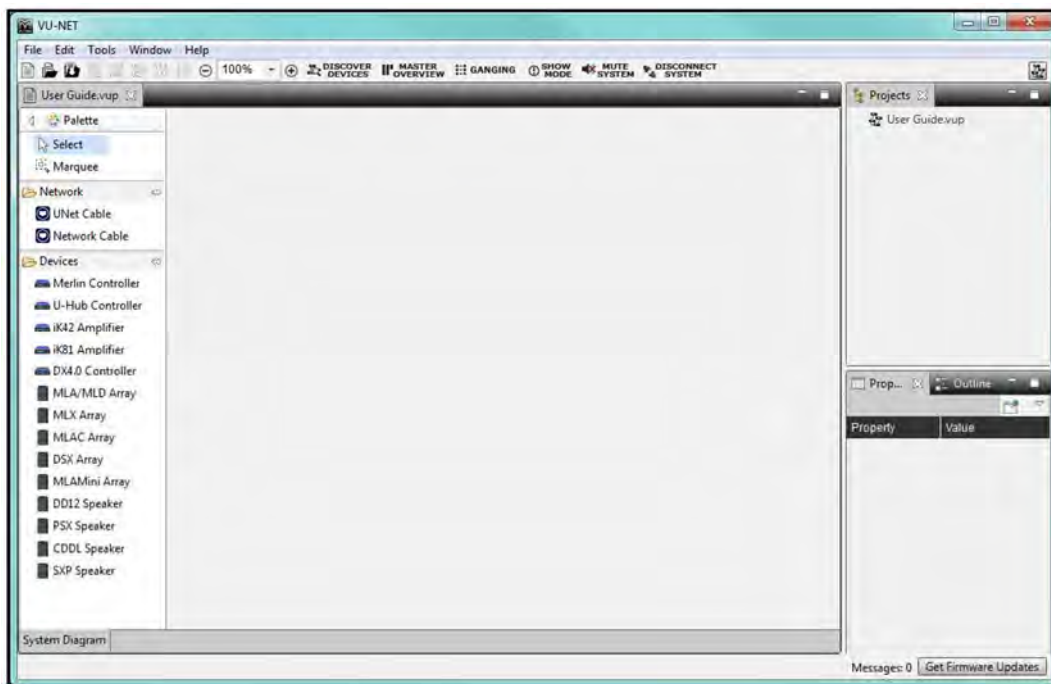

You will notice that the top left of the main window has your project name and a number of options on the toolbar are now available.

## Window components

The window has a number of distinct sections with their own function; -

### Menu and Toolbar

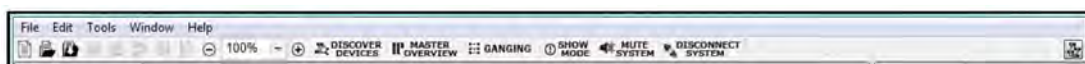

Along the top of the window is a standard file menu and tool bar which gives quick access to a number of functions; -

## File

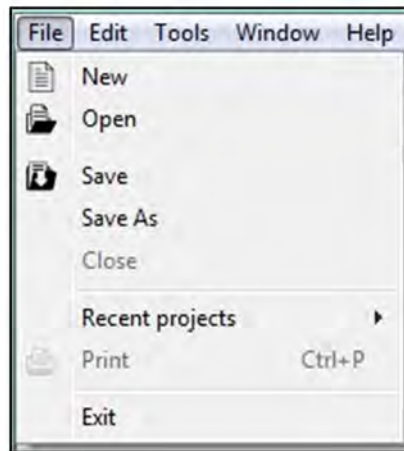

The File menu controls all file management tools. The 'New' duplicates this function on the tool bar and is how you create a new project. Note that you cannot have several projects open simultaneously. If you select 'New' with another project already open you will see the following Window; -



'Open' enables you to open a project you have previously created and saved. As Vu-Net does not have an auto-save function it is wise to save your work at every step as is good practice for any application.

'Save' is the standard Windows function to save the project, if it is the first time you have saved the project a window will appear giving you the opportunity to give the project a name and to choose a convenient file locations. As with Display 2.1 it is sensible practice to save the file in a folder dedicated to a specific event. All subsequent Saves will overwrite the existing file. As shown, the keyboard shortcut Ctl+S can be used to save a project. It is a good idea to frequently save your work. Vu-Net files are saved with a .vun file extension.

'Close' closes the presently active project.

'Save As' gives you the facility to save your project with a different file name, retaining the original project. This could be useful if you wanted to try something but still have the option of returning to you original project file.

'Recent Projects' lists all VU-NET projects recently opened making it easy to find a project you may need to re-open.

'Print' will print the system layout in the main system overview window.

'Exit' will close the application

## Edit

The Edit menu has a number of functions available; -

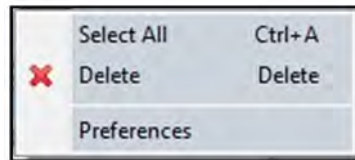

Note that additional edit menu items are displayed depending on which active devices have been selected in the System diagram overview, Product such as MLA and MLA Compact have Presets that can be loaded or saved and zones that can be defined, other devices such as DD12 or CDD-Live have Snapshots for loading or saving.

'Select All' selects every item on the main project window. All selected items will show four square black dots in the corners around the object or objects.

## Preferences

Preferences have some important options for how Vu-Net operates; -

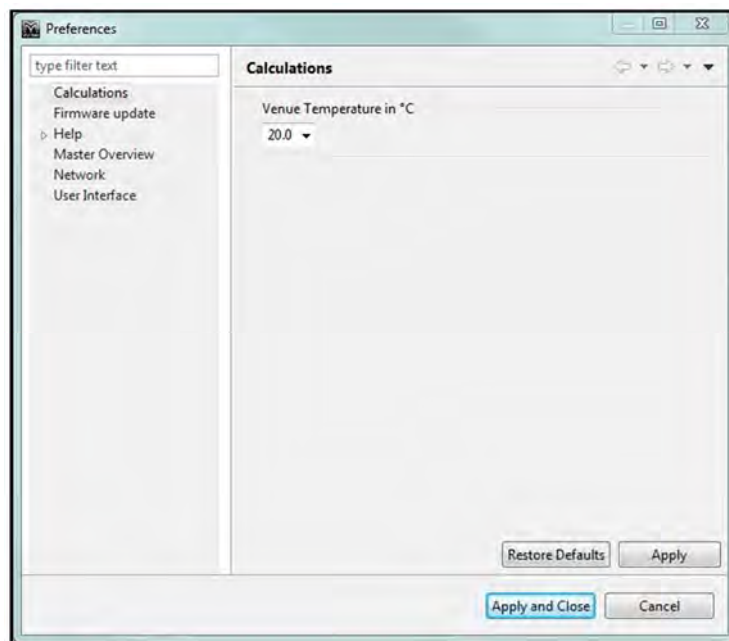

**Calculations:** The first option is labelled 'Calculations' and allows you to select the venue temperature in steps of 5°. This is used when the option is selected in the Merlin Controller to read delay figures as a distance as opposed to time. The temperature adjustment calculates the delay time according to the speed of sound at that temperature. Select the desired temperature using the drop down box or an exact value may be typed directly into the box and click 'Apply'. Note that if you have a Merlin open in the project window the change will not be visible until you close it and reopen.

**Firmware update:** The next option is Firmware update; -

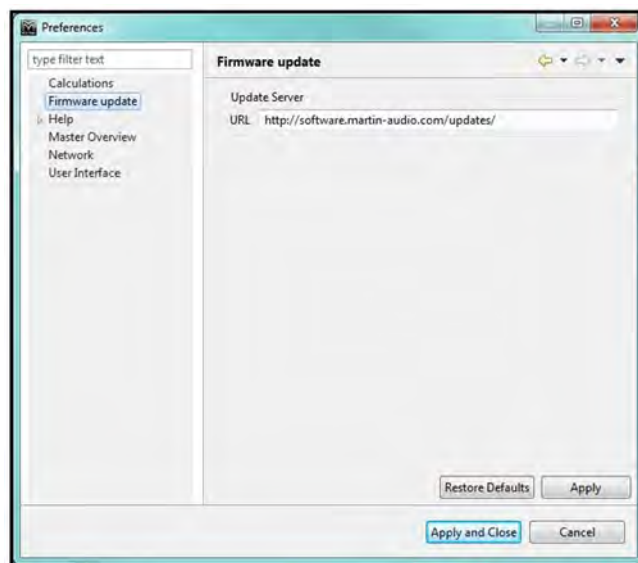

This shows the web URL for the system to search for firmware updates which will be covered in the Firmware chapter. ***This should not be changed unless notification is received from Martin Audio to do so.*** If however it accidentally gets changed or deleted it is possible to reset all Default parameters by clicking on the Restore Defaults button. Note that this restores ALL Preferences so any that you wish to retain will have to be re-entered.

**Help:** Next are options for how the Help menu is displayed; -

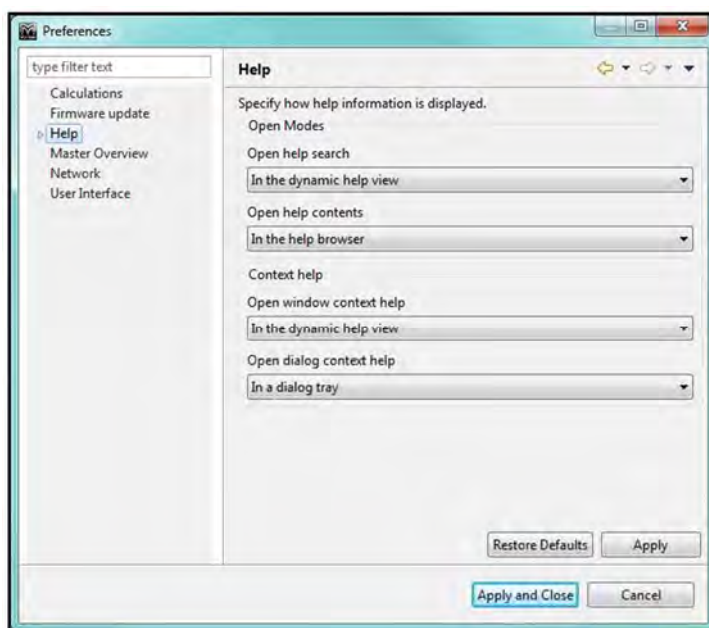

By default the help window is displayed in a dedicated help browser but you can select it to open in your default Internet Browser. Context help which responds dynamically to objects selected can be displayed as a window on the application or as an “Infopop”

Help includes a sub-menu for accessing help from remote infocenters. This is not currently operational and will be a future upgrade.

**Master Overview:** There is an option within Master Overview to show the Merlin Controllers in the system in the Overview tab. This is for systems where Merlins are used purely as a network interface with no audio passing through them which would make it unnecessary to monitor them in the Master Overview screen



By default the Master Overview opens in a secondary floating window, particularly useful when monitoring large systems with your PC connected to two or more screens. You can select the option to display the Master Overview as an embedded window within Vu-Net- it will appear as another tab in the same way as double clicking on any of the devices; -

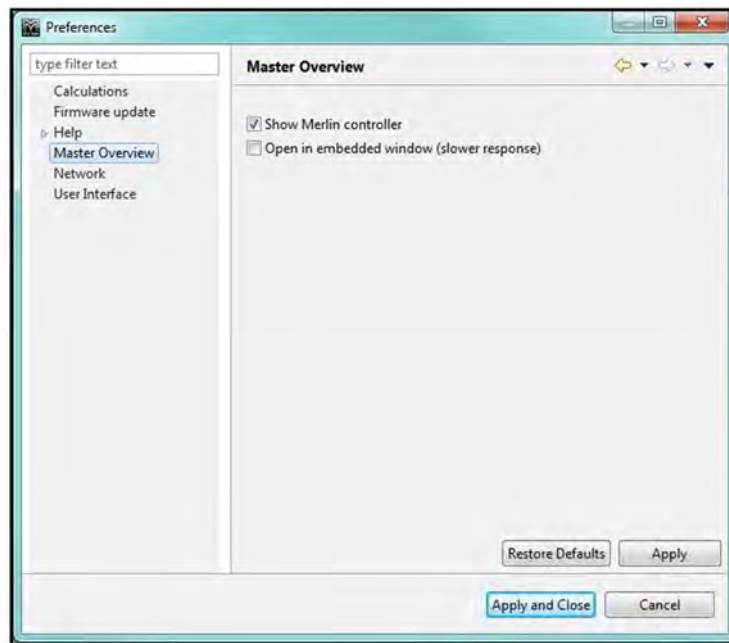

**Network:** The Network option is an important section for determining how devices are found on the Ethernet network; -

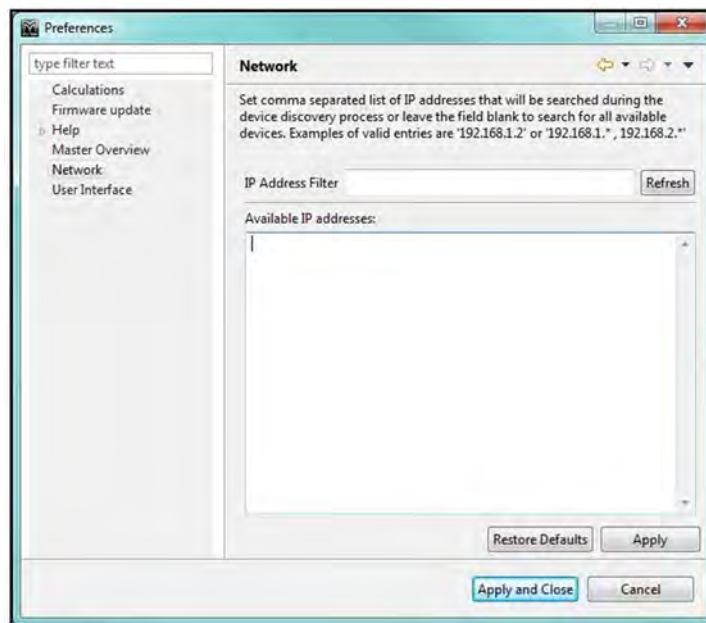

Running the application off line will display a blank window. When you have one or more Merlin or U-Hub connected (usually at least two for MLA and MLA Compact systems) their unique IP address will appear listed in the bottom 'Available IP addresses'. You can set an IP address Filter in the smaller window which will search only for IP addresses within the range of values between the two entered which should be separated with a comma; -

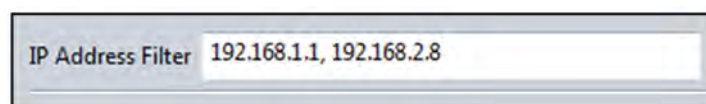



This could be used if you have two systems running on the same Ethernet network and need to control them independently. Only devices with their IP address set to values within the filter range will be found and the system will work completely independently as if there were no other devices on the network.

Note that if you are connecting to MLA Mini, DD12 or PSX via their integral USB port, no IP address will be visible. This function is only applicable to networks supported by Merlins, U-Hub or Ethernet connected devices such as the CDD Live range.

**User Interface:** The final option in the Preferences window is User interface; -

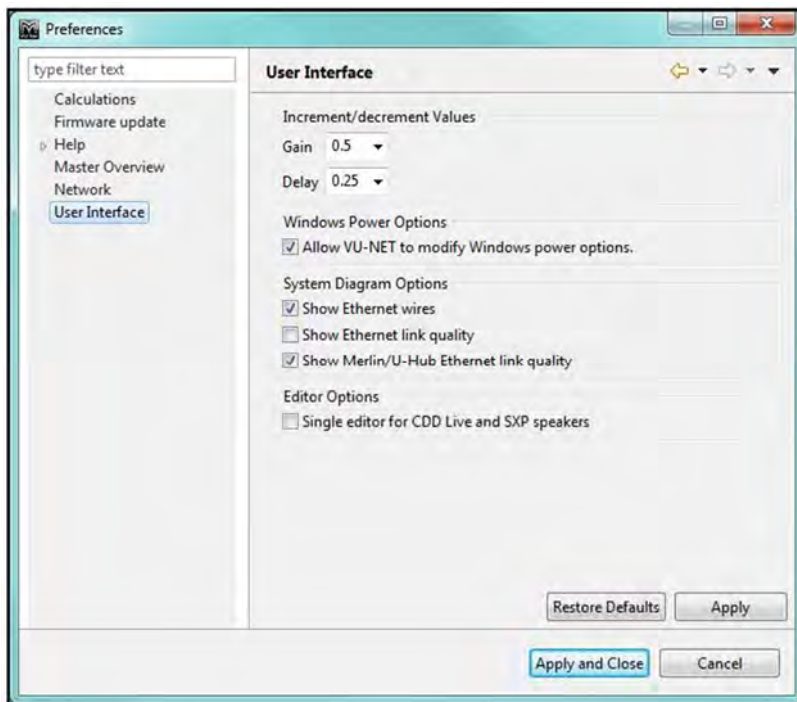

This allows customisation of certain functions within the application.

**Increment Values;** -

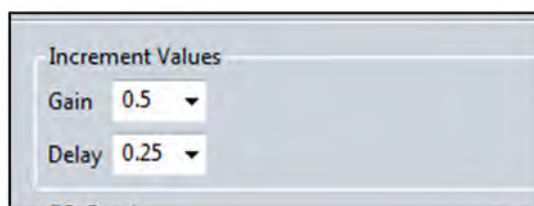

These allow the default increment values for both Gain and Delay to be changed as required. The default for Gain is 0.5dB but the options are for increments of 0.1, 0.2, 0.25, 0.5 or 1dB.

For delay, the default is 25ms, the options are 0.1, 0.2, 0.25, 0.5 or 1ms.

**The Windows Power Option;** -

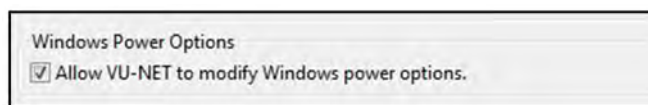

Allows Vu-Net to prevent Windows from implementing changes to the power settings that can effect network operation. This should be left checked unless there is a very specific need to do otherwise

Finally there are a number of options for how the system diagram is displayed; -

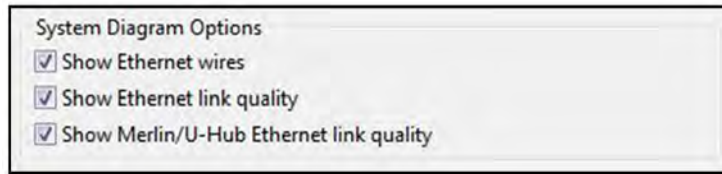

This is intended to reduce the number of lines on the System Diagram overview which may get cluttered in large systems with a high number of devices. You can show or hide the Ethernet connections and link quality from the control PC to Ethernet enabled devices which includes Merlin, U-Hub, CDD-Live, IKON amplifiers and DX4.

Finally you can select whether CDD-LIVE and CSX-LIVE products appear in a single editor window; -

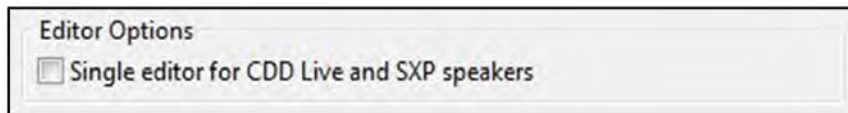

## Tools

The tools menu; -

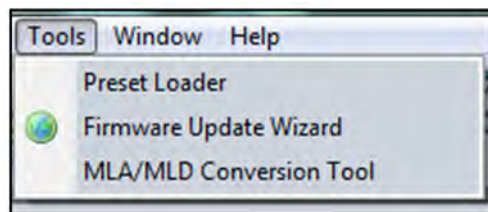

This has three important functions for system operation.

**Preset Loader** is used to upload EQ optimisations into the arrays.

**Firmware Update Wizard** is used to check and upload the latest firmware into the system components. This function is also available from the button in the bottom right hand of the project window **Get Firmware Updates**.

**MLA/MLD Conversion Tool** is used to convert the amplifier modules used in MLA and MLD cabinets from one type to another. Mechanically and electrically these are identical, they simply need a firmware conversion so the system is aware of what type of enclosure they are powering. An MLD module can be converted to an MLA or more commonly an MLA module to an MLD.

## Window

The Window menu is used to determine which sections of the project window are displayed; -

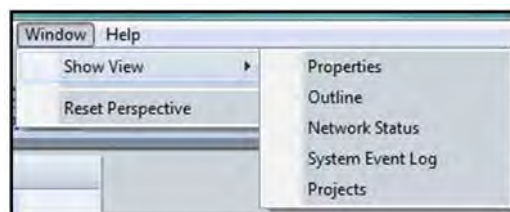

The System Diagram is always visible but the other windows can be closed and reopened as required. By default they are all open but if closed they can be reopened by selecting them from the Window menu. The Reset Perspective option will restore the project layout to the default view.

## Help

The help menu has a number of options; -

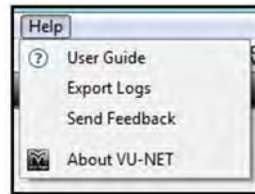

**User Guide:** This is essentially a link to this very guide slightly rearranged for use in the field when running the software. The contents page features links directly to the specific subject so you can very quickly navigate to where you need to be to discover the answer to something you don't fully understand.

**Export Logs:** This is an important function to assist the Martin audio software team to identify bugs in the application. If you have experienced unexpected behaviour in Vu-Net the Product support team may ask you to e-mail the log file for the Vu-Net session that you were using. This is achieved from this window. Click on Export Logs and the following window appears: -

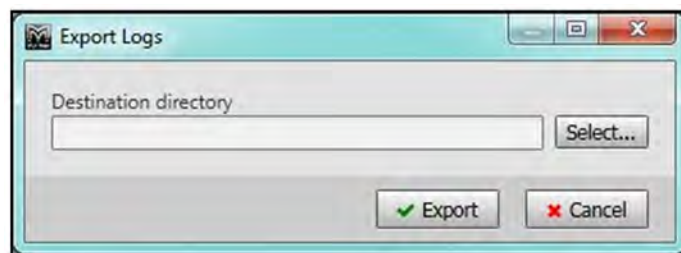

Click on Select to navigate to a convenient location on your PC hard drive then click Export to download the log file. If your export is successful you will see the following window; -

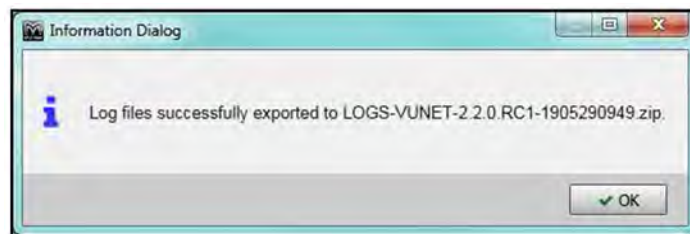

**Send Feedback:** opens a communication window which gives you an opportunity to communicate any issues or ideas for new features straight back to Martin Audio; -

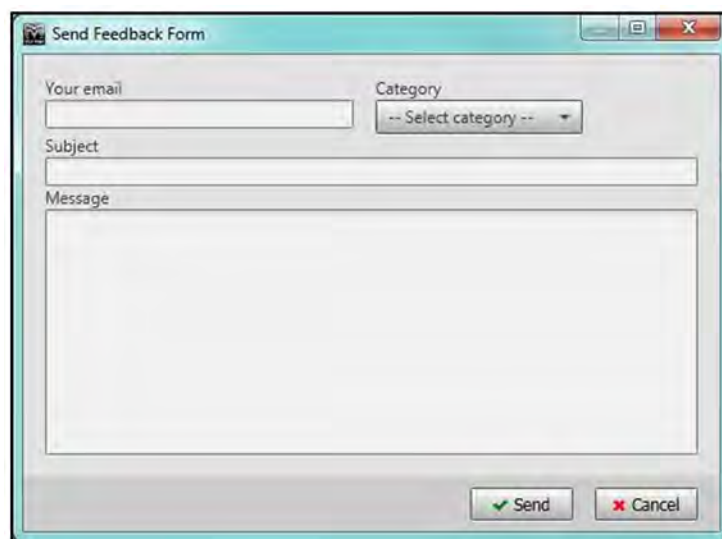

Note that an internet connection is required for your Feedback to reach Martin Audio.

## Tool bar

The toolbar has a number of icons which offer either quicker access to commonly used functions from the file menus or specific functions which are essential to system set up and operation.

The first three icons are file management tools; -



These are New Project, Open existing project and Save.

The next group are graphic alignment tools for making your system diagrams look neat; -

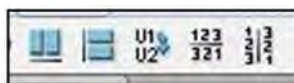

The first, second, fourth and fifth of these are only active when two or more components are selected; the third is only active when one or more Merlin or U-Hub controllers are selected.

The first icon aligns all selected components horizontally on the page. The second aligns all selected objects vertically. The third tool is used with the Merlin and U-Hub. When a system is discovered its network connections are drawn in place. The two U-Net nodes on the Merlin or U-Hub, usually run as a closed loop will go off to the first cabinet in the array and back from the last cabinet. Depending on the layout of your system diagram this may mean that network cables are crossing over looking a little messy. This tool reverses the two network nodes in the diagram to try and neaten the diagram. Note that it is only adjusting the graphic representation; it is not making any electrical changes to the U-Net nodes in the Merlin or U-Hub.

The final pair of icons will reverse the position of any selected objects. Perhaps you have an MLA array to the right of an MLX array and you would rather position them round the other way, you just select both arrays and click on the 'Reverse order horizontally' button and their order will be reversed maintaining their connections and keeping them aligned. Likewise if you wish to reverse the vertical order, position DSX subs under an MLA Compact array when the diagram has the subs on top, select the required components and click the 'Reverse order vertically button'

**Discover Devices** is the method by which U-Net connects to all system components once all hardware connections have been made; -



This will interrogate the U-Net network and find all connected devices opening Wizards for each type of device; MLA & MLD, MLX, MLA Compact, DSX, MLA Mini, MSX, DD12, CDD Live and Merlin. All devices on the same U-Net loop will be grouped together by type by the discovery process. Note that Vu-Net will discover devices regardless of how they are connected, either directly by USB in the case of MLA Mini, DD12 or PSX, via Ethernet for CDD Live and CSX Live, or over a U-Net loop via a Merlin acting as a network bridge

**Master Overview;** -



Gives an overview of all devices in the project displaying all bargraph level meters giving access to essential functions such as gain, mute and Delay and with a link to EQ functions. This is designed to be used once a show is in progress to allow easy



monitoring of an entire system from a single page. The Master Overview is opened as another tab next to the Project System diagram and any other open arrays or components.

**Ganging;** -



From version 2.1, Ganging for all devices is accessed from the toolbar using this button. A list of all device types is displayed, selecting the appropriate device will bring up the ganging window that was previously accessed from a tab in the device window;



As the name suggests, this is intend for use during a show once set-up is complete. It changes the operation of the Mute function for all products. When disabled, all mutes can be selected and de-selected freely, when show mode is active;

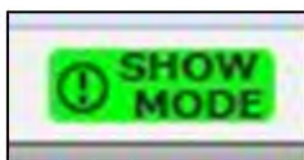

Any click on a mute button will bring up a pop-up window asking you to confirm that you want to Mute or Un-Mute that array or channel. It also disables the output cell check function, see later in this guide for details

The zoom function;

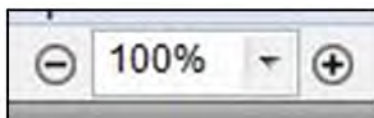

Allows you to adjust the system diagram size to suit the complexity of the system on your PC display. The '-' and '+' buttons will decrease or increase the zoom in increments of 25%. Alternatively you can use the drop-down box to select either 10%, 25%, 50%, 100%, 125%, 150%, 200%, 300%, 400%, 600% or 800%. Particularly useful are 'Page' which will zoom to the maximum size that the page will allow, 'Width' which will zoom to the maximum width of the diagram and 'Height' which will maximise the size to fit the height of the diagram.

Mute is essentially an "emergency" function if something is causing severe noise through the system you can click on the mute button;



This will bring up the following window;



As you can see it is a very drastic measure which will shut down the entire system which is why it should be considered as an emergency measure only and not an everyday means for muting the system. If you are sure you wish to proceed you can select 'Yes' if not click on 'No' and the window will disappear, the audio will remain routed. This function mutes every input and output on connected Merlins and every zone on all arrays. *Once used there is no global un-mute*, all Merlins and arrays will have to be individually un-muted. Note that Show Modes does not change operation of the System Mute, the confirmation window will always appear.

Our advice is never to leave a system muted within Vu-Net, always use a mute that can be defeated manually such as a Merlin output. If a system has been muted within Vu-Net and for some reason you lose network connectivity you will be unable to un-mute and will have an unusable system!

### System Disconnect



This will disconnect the project from the hardware in the system. A Window will pop up giving you a selection of options; -

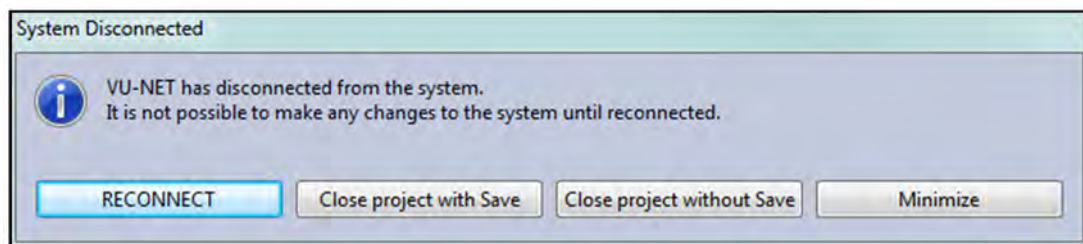

As you can see, once you are disconnected from the system you are unable to make any changes to the project, this is to ensure compatibility and accurate synchronisation when you reconnect. You have the option to reconnect straight from the window or can close the project with or without saving. Finally you can minimise the project. This is particularly useful if you have disconnected to switch from a Wi-Fi to a hard-wired connection, having minimised to can access the PC network setting to make the switch to a cable Ethernet connection.

Once Disconnected the Disconnect button will change to reconnect also allowing you to reconnect to the project; -

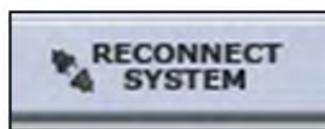

### Project Workspace

The workspace is divided into several sections which can each be opened, closed or in the case of the ancillary section, "detached" as a floating window.

By default the workspace appears like this; -

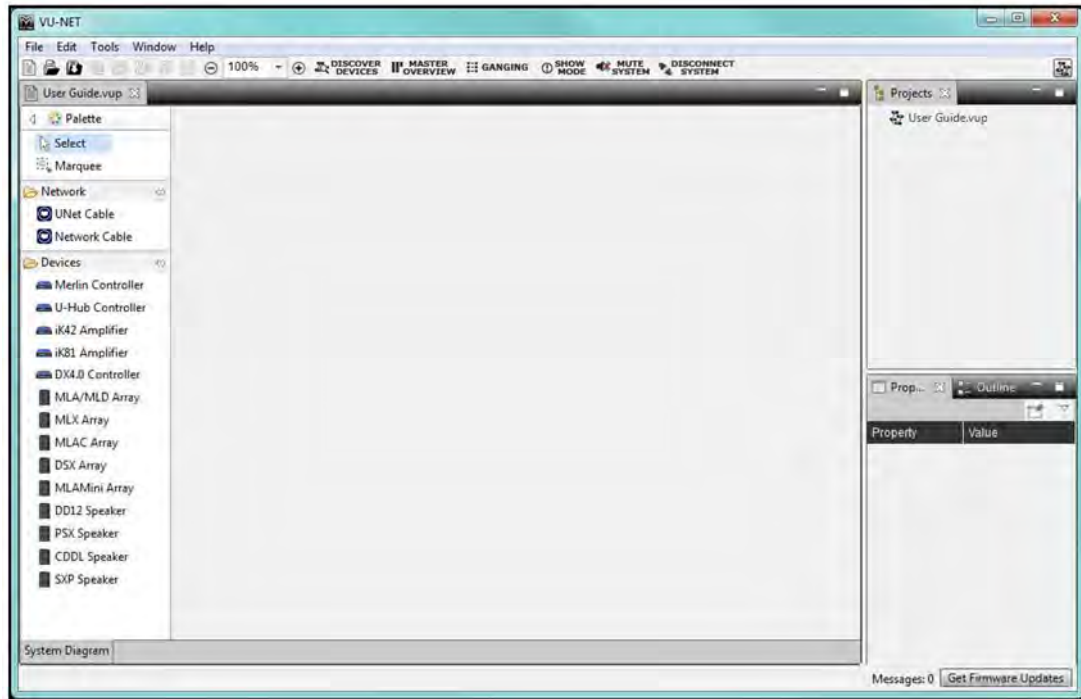

There are three main sections, the first is the system diagram; -

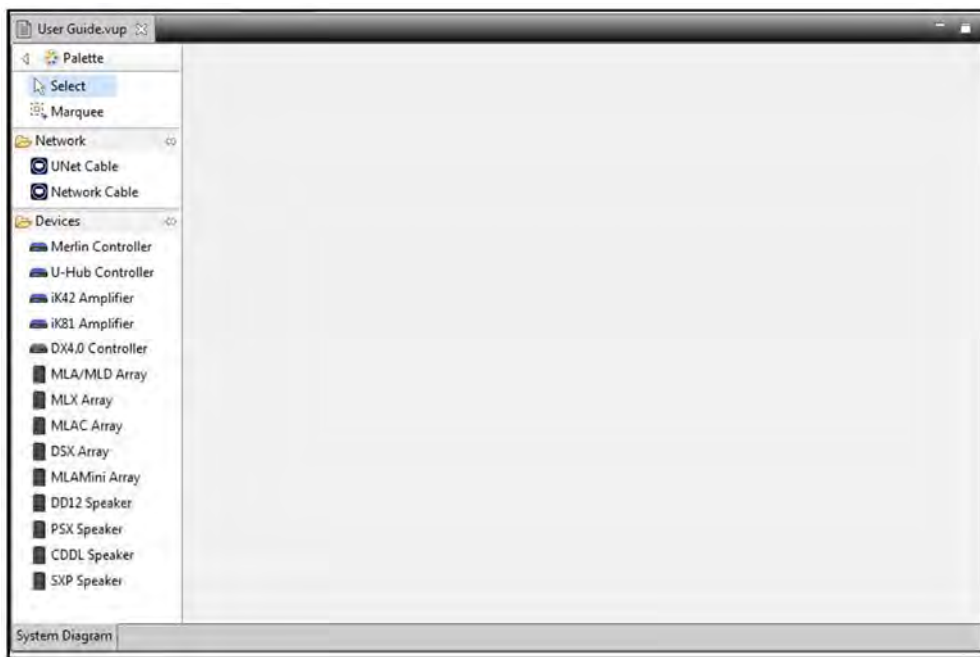

This window will show all array components on the network and is used for all configuration changes and system monitoring. The palette on the left is used to manually enter system components when working off line (in normal use, Device Discovery is used to find all connected components). If you need to maximise the workspace the palette can be minimised by clicking on the white triangle in the top left corner of the palette; -



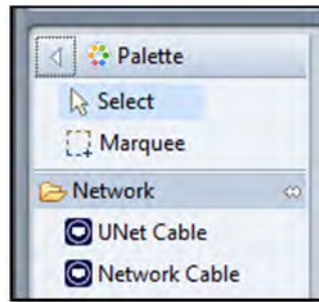

The overall size of the System Diagram can be increased or decreased by clicking and holding on the gap between its right-hand edge and the left hand edge of the other windows. You can then drag either left or right to adjust the relative sizes of the windows. Alternatively, the white drop-down arrow gives you the option to maximise the screen. The other windows will not be closed; they will be represented by an icon on the right side of the page with the option to restore. Clicking restore will return the windows to their previous state.

On the right side of the window are two further windows; -



The first is a project overview window showing the open project. The window can be maximised, detached or closed by clicking on the white arrow in the top right corner. The project icon can be expanded if they have a small arrow to the left (a project that doesn't yet have any components added or discovered will not show an arrow). This will then show all connected components as in the picture above. Arrays will have a further arrow which if clicked will show all individual cabinets. This screen grab shows an enlarged project window in which the User Guide system has been expanded and one of the MLA arrays and one of the MLX arrays have also been expanded; -

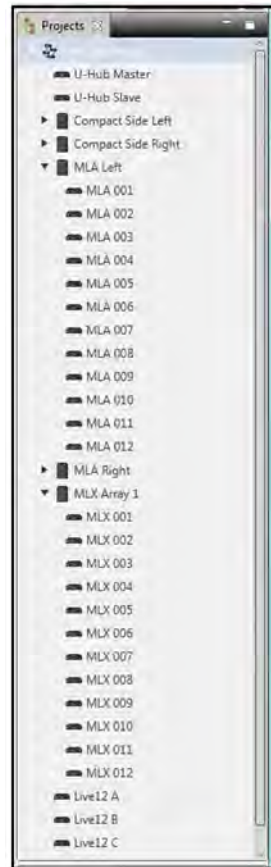

The final window by default has Properties and Outline available but by using the 'Show View' option in the Window menu, you can also select Network Status. This shows all three options available; -



Any of the three options can be viewed by clicking on the relevant button. As with the Project window any of the selected options can be detached as a floating window, maximised or closed by clicking on the white arrow. If all options in the window are closed the project window will fill the space, if that is also closed the Project window will fill the space.

The Properties window will show the properties for any element selected in the System diagram. The example above shows the properties for a U-Hub in an off-line project. There are a number of options available for the Properties display selected by the icons in the top right corner of the window; -

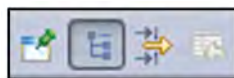

The first pins the Property view of the selected element so it remains on view regardless of whether an alternative element or even project is selected. A second click on the icon will un-pin the view and any new selected element can have its properties displayed.

The next is the Show Categories button which is selected by default. This shows the categories for each of the properties and gives the option to display or hide any of the properties in a particular category by clicking on the small arrow leaving just the category heading.

The third icon displays advanced properties for the selected element.

The final icon will reset any modified properties to their default values.

The Outline window displays a miniature thumbnail of the system diagram for whichever project is selected; -

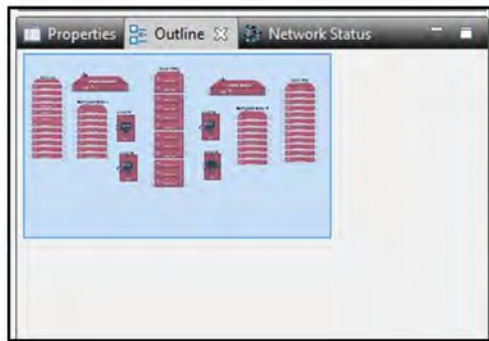

The network status shows the status of the network connection to all elements in all projects running in Vu-Net. This screen shot shows the network status of the elements in an MLA/MLD & MLX system (currently off line); -

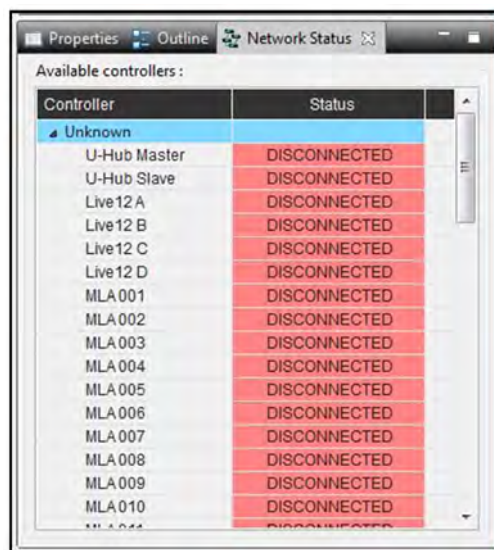

Available controllers:	
Controller	Status
Unknown	
U-Hub Master	DISCONNECTED
U-Hub Slave	DISCONNECTED
Live12 A	DISCONNECTED
Live12 B	DISCONNECTED
Live12 C	DISCONNECTED
Live12 D	DISCONNECTED
MLA 001	DISCONNECTED
MLA 002	DISCONNECTED
MLA 003	DISCONNECTED
MLA 004	DISCONNECTED
MLA 005	DISCONNECTED
MLA 006	DISCONNECTED
MLA 007	DISCONNECTED
MLA 008	DISCONNECTED
MLA 009	DISCONNECTED
MLA 010	DISCONNECTED
MLA 011	DISCONNECTED

## Working Offline

Before we move on to look at adding elements to projects it is important to understand the difference between working off line and normal on-line operation at an event. When working off line the Palette allows you to drop elements into the System Diagram, you can open arrays, speakers and Merlins as you would for an on-line system. This is useful as a means to get used to system operation in Vu-Net but very little beyond that. Unlike some systems you CANNOT create a system design off line and connect to a system on site. When connecting to a system you have to use Device Discovery which searches all available connected devices for system elements and automatically drops them into the system diagram showing their Ethernet and Vu-Net Connections. This is vital as every Vu-Net element has a unique factory set IP address which Vu-Net records so it can provide real-time monitoring of the system and can display the status of every device. If for example you re-connect to a system having used it on one day and shut down over night, Vu-Net will be able to detect that every cabinet has been turned back on and the status of all parameters of every DSP. We will show how to introduce all available elements into a project off line but will cover Device Discovery and on-line operation in a later chapter.

## Adding Merlin, U-Hub, MLA, MLD and MLX

Adding any devices to a System diagram is a simple case of clicking on the required item in the Palette; -



Then click on the System Diagram workspace. The cursor will have a small white box with a cross in the centre prompting you to click where you wish to deposit the device. Here we see a new Merlin added to a project; -



The four black squares in the corners indicate that the device is still selected which is the default when a new element is added to a project. The most useful thing about this is that it gives you the opportunity to move it to exactly where you need it simply by using a click-drag-drop movement. A click anywhere else in Vu-Net will de-select the Merlin.

Adding an MLA/MLD array is done by clicking on the icon and then in the project window, you will see the following window; -

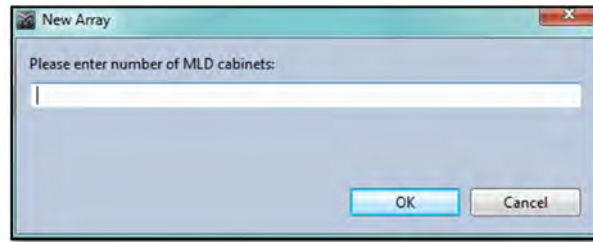

Enter the number of MLD required in the array. In the majority of systems this will be one or two. They will automatically be added to the bottom of the array.

Next this window appears; -

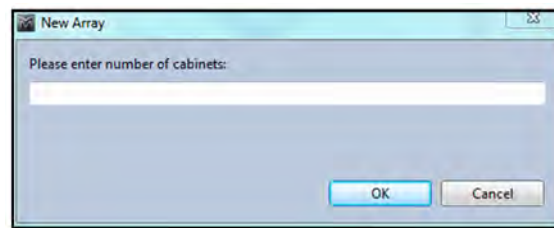

Note that you must enter the total number of cabinets including the MLD, NOT the number of MLA. The array will appear in the workspace like this; -



The array is greyed-out to show that it is off line. Note that the largest array that can be added is a total of 24 cabinets which matches the maximum flown array from the flying grid. If you enter a number higher than 24 Vu-Net will enter a 24 box array.

MLX is added in the same way, you will see the same window requesting the total quantity of cabinets. Here is a six box array of MLX, note that in off-line mode sub arrays are always entered a single column of cabinets as if flown. Device Discovery of an on-line system gives you the option to specify ground stacked and draw the array exactly as it has been physically positioned; -



### Adding MLA Compact & DSX

MLA Compact is added in exactly the same way, the only difference is that as there is no downfill enclosure you are simply asked the total number of cabinets; -

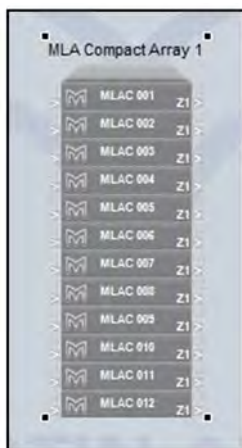

DSX has a slightly different option. When DSX Array has been selected, you will first see the standard window asking for total number of cabinets. When this has been entered you will see the following window; -

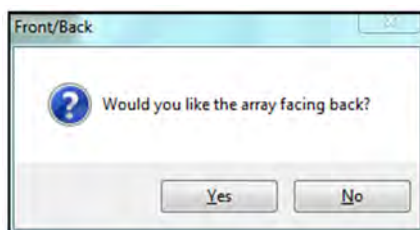

With MLX and DSX it is easy to build and operate directional sub arrays, one of the most popular of these being the gradient or "CSA" array with a third of the subs facing backward and phase inverted. When devices are discovered in normal use their LED badges can be flashed to help identify which actual cabinets correspond to the icons in Vu-Net. Both MLX and DSX are designed to be used either front or rear facing and there is a front and rear LED badge so you can still easily identify the cabinet even when facing backward. In on-line mode you can select front or rear badge during the Device Discovery process but off-line you can specify rear facing when adding the array, the idea being you would add all front facing cabinets as one array and all rear facing as a second. You will have noticed the 'F' on each cabinet on the MLX array, if you select rear facing for the DSX you will see a 'B' to indicate the back LED has been selected. Here is a typical Cardioid array comprising six DSX; -



The most common deployment for this configuration would be stacked two wide, three high with the middle two cabinets rear facing.

### Adding MLA Mini

MLA Mini is deployed in blocks of four MLA Mini plus an MSX sub or amplifier module to driver them. This makes entry to Vu-Net a little different. First you need to specify how the system is to be physically deployed, the following window appears when you select MLA Mini Array and click in the System Diagram workspace; -

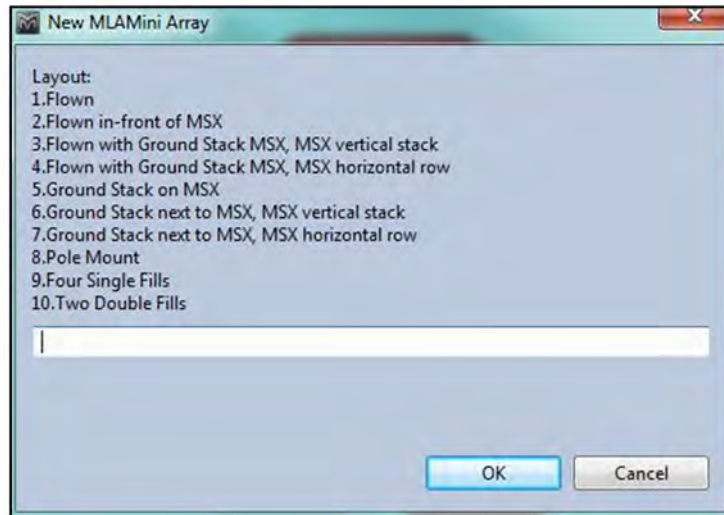

1. Flown refers to a system with MLA Mini flown below the MSX sub using the flying frame and transition grid. The maximum configuration for this mode is three sets of Mini and MSX (twelve MLA Mini cabinets).
2. Flown in Front of MSX allows the maximum flown array of MLA Mini which is sixteen cabinets and allows for configurations with the MLA Mini flown using the flying grid with up to four MSX on a second grid flown behind the Mini.
3. Flown with Ground stack MSX, MSX vertical stack is from four to sixteen MLA Mini flown using a Universal Bracket (maximum four cabinets) or flying grid with the MSX on the ground under the array stacked on top of each other vertically.
4. Flown with Ground stack MSX, MSX horizontal row is from four to sixteen MLA Mini flown using a Universal Bracket (maximum four cabinets) or flying grid with the MSX on the ground under the array in a row horizontally.
5. Ground Stack on MSX is possible with one or two MSX and four or eight MLA Mini.
6. Ground Stack next to MSX, MSX vertical stack allows ground stack arrays with the MLA Mini stacked directly onto the ground, perhaps at the front of a stage for example, using the flying grid and the ground stack base plate. Two systems (eight MLA Mini) can be used in this configuration. The MSX would be placed to one side of the MLA Mini array stacked on top of each other when two are used with eight MLA Mini.
7. Ground Stack next to MSX, MSX horizontal array allows ground stack arrays as option 6 but with the MSX to one side of the MLA Mini array placed horizontally in a row when two are used with eight MLA Mini.
8. Pole Mount adds a single system of one MSX with four MLA Mini above on a pole mount.
9. Four Single fills is for using the MLA Mini individually as stage front fills for example.
10. Two double fills pairs the Mini to create two fills for various applications.

If you have selected the deployment options 1, 2, 3, 4, 5, 6 or 7 you will next be asked to select the number MLA Mini cabinets;

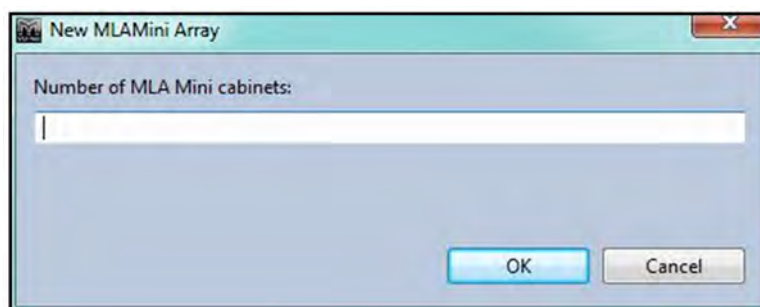

If you select a number greater than is possible for the desired deployment Vu-Net will automatically restrict the number to the maximum allowed.

Here are a few examples of MLA Mini arrays, first a single flown array; -



Next a systems with MSX ground stacked horizontally and MLA Mini flown;

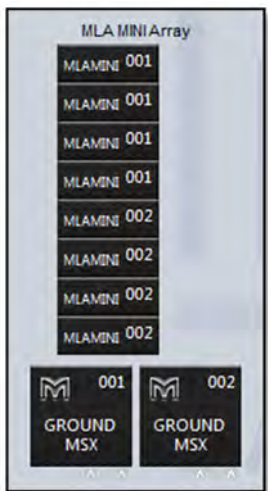

Finally a single system with the MLA Mini pole mounted;





## Adding DD12

DD12 can be added individually dragged across from the device menu; -



## Adding PSX

PSX is also added in the same way, clicking on PSX in the Devices list and clicking in the system diagram workspace; -

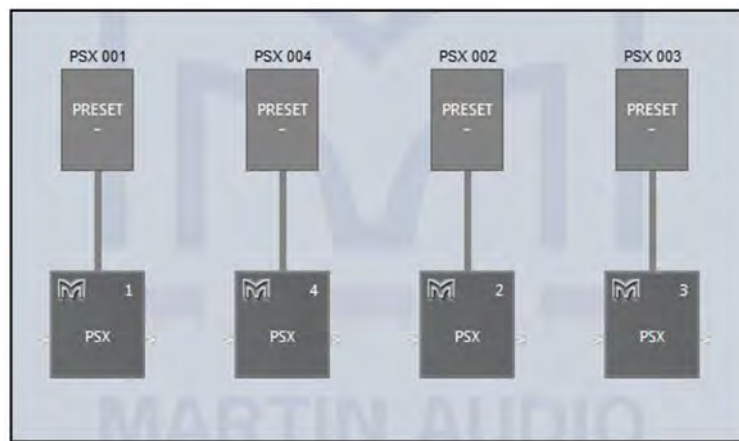

As the system is off line there is no preset showing and the satellite cabinet is a generic shape. When used on line and selecting one of the three factory presets for either DD6, CD12 or XD15 the thumbnail picture reflects the selected cabinet.

## Adding CDD Live

There are two CDD Live options in the Devices list, one for CDD Live full range cabinets and a second for the CSX Subwoofer from the range. Adding CDD Live will bring up the following window allowing you to select one of the three full range models, CDD Live8, CDD Live12 or CDD Live15; -

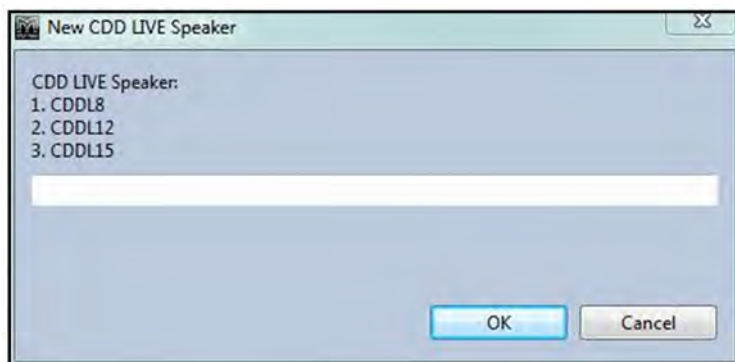

Type 1 to select CDD Live8, 2 to select CDD Live12 and 3 to select CDD Live15. Here we have added one of each product; -

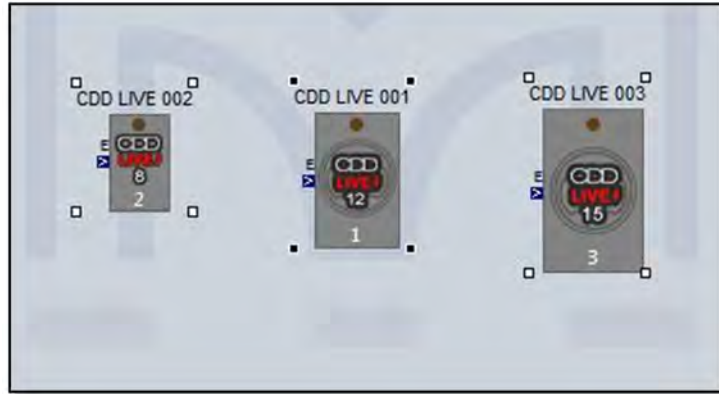

### Adding SXP (or CSX-LIVE)

The choice of SXP Subs brings up an option window; -

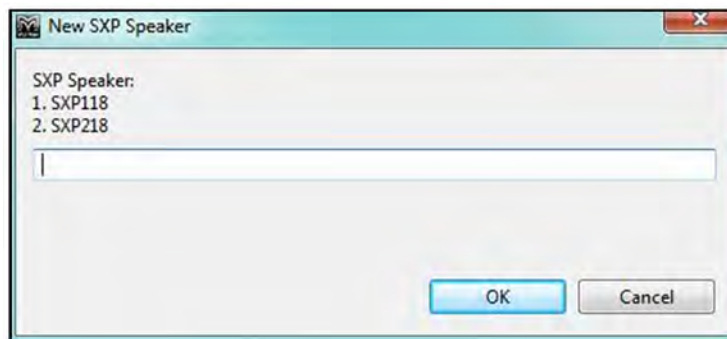

Typing 1 adds a CSX Live118 and 2 adds a CSX Live218; -



### Adding iKon Amplifiers

iKon amplifiers are simply dragged and dropped into the System diagram, there are no options to select; -

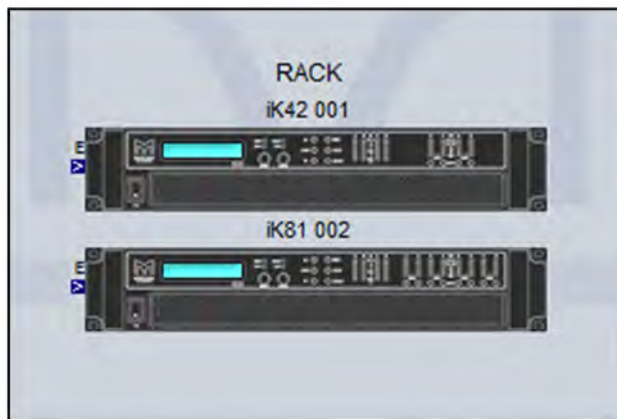

iKon amplifiers will always lock together in a single column designated as a "rack" when first added to Vu-Net (either off line or via Device Discovery). Amplifiers can be sorted into as many racks as required, even down to having one amplifier in each rack if necessary. This is done using the Preset Manager option which is part of the right-click menu for the amplifiers.

### Arranging the Array components

Vu-Net has a number of tools available to help keep the system diagram looking tidy.

Selecting elements can be done in a variety of ways. The most obvious is a single mouse click; the selected object will show the small black squares in the four corners around it. A subsequent click anywhere else will de-select the object, as will click on a second object. The selected element can also be changed using the left, right, up and down arrow keys, the object selected will jump in the direction of the keys.

Selecting multiple objects can be done two ways. First you can draw a box around multiple items. Click and hold in the corner of a group of objects and drag over all of them diagonally. A box will appear round all selected items until you release the mouse button whereupon all objects within the box will be selected. You can draw the box from any corner in any direction.

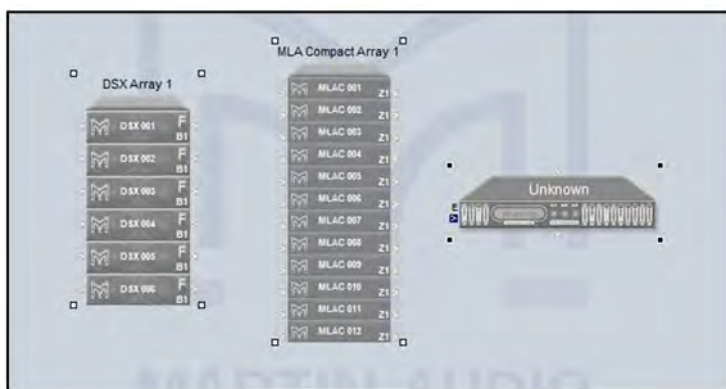

If you need to repeat this action several times you can select the Marquee tool from the Palette menu which changes the mouse cursor to a cross and enables box-drawing mode. Click on the Select icon in the Palette to return to normal select mode.

Secondly you can click to select an element then press and hold either Ctrl or Shift and click on all other elements you wish to select. Note that you can use a combination of selection modes if necessary; use the box-drawing method initially then Ctrl or Shift click to add additional elements to the selection.

Deselecting an element from a multiple selection must be done with Ctrl + click. With a multiple selection there is always one primary element, by default the last one added to the selection. This will have the familiar black squares in the corners; all other selected items will have white squares. You can change the primary element by a further Shift + Click on an object. Deselecting all objects is done in the same way as a single item by clicking anywhere on the work surface.

The icons on the tool bar offer quick and easy alignment of multiple objects, there are five tools available; -



The first aligns objects horizontally, here is a before and after of four arrays that have been selected; -

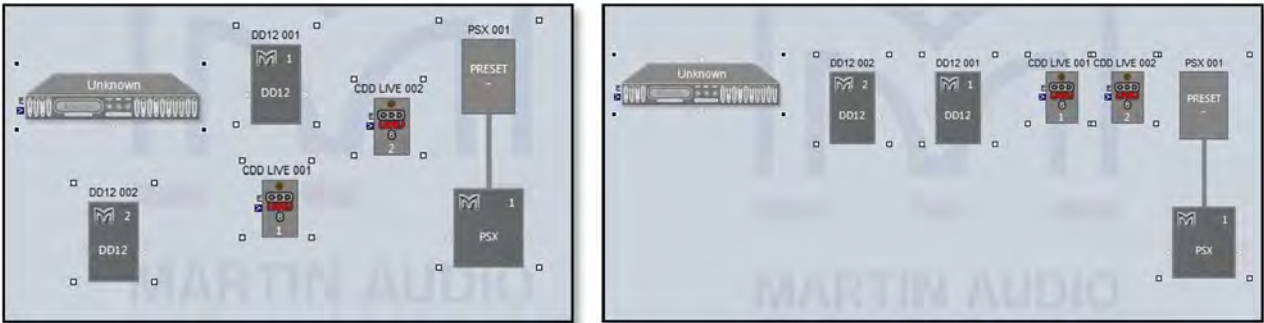

In the left hand shot the arrays have been positioned roughly in a line and all selected the right hand shot shows them all neatly lined up in a horizontal line.

The second allows alignment in the vertical; -

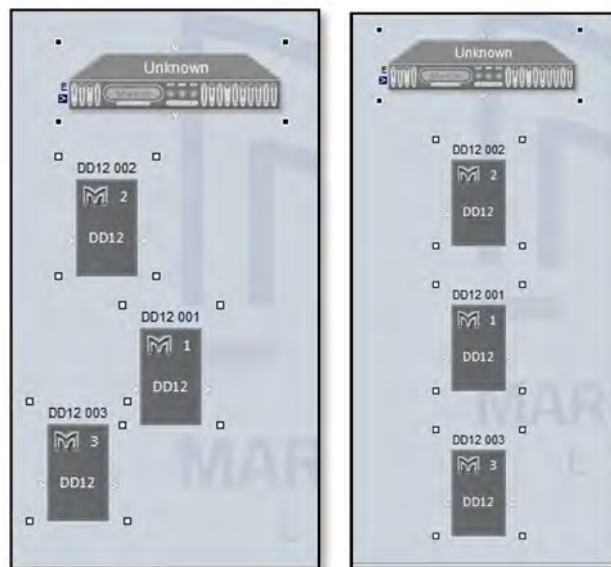

Again the arrays are not very well aligned but a simple click of the vertical alignment button and they are perfectly in line.

The fourth button will swap the horizontal position of all selected elements; -

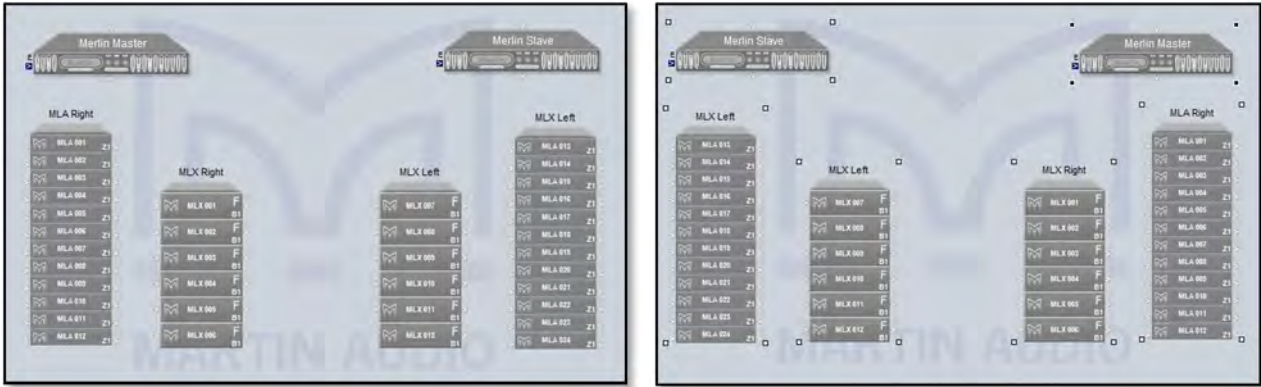

The left hand shot shows a system drawn with the left and right arrays placed on the wrong sides, the right shot has been corrected with the reverse order horizontally button.

The fifth button swaps the order of all selected items in the vertical plane; -

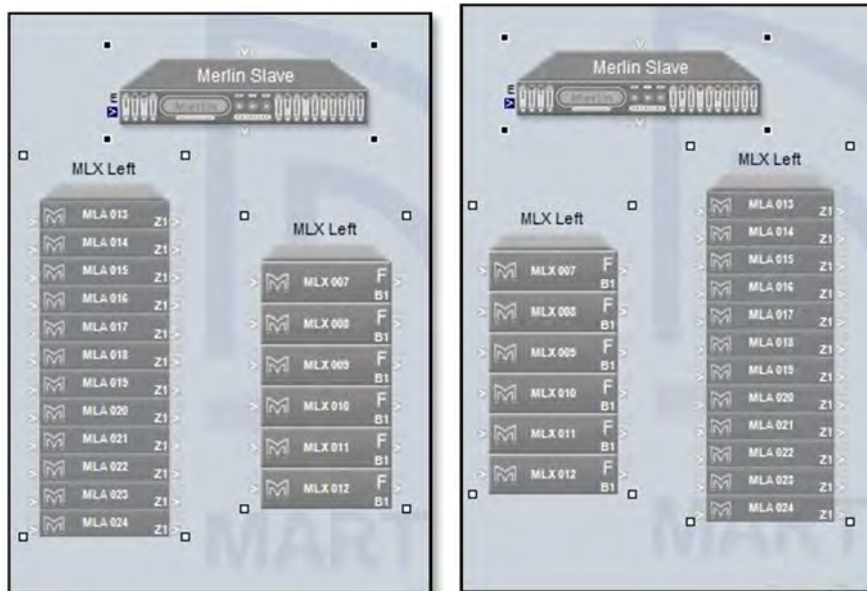

The third button applies only to the Merlin. When a system is discovered on line all U-Net connections are shown from the Merlin to all arrays; -



The U-Net ports on the Merlin are on the top and bottom of the Merlin icon, in most cases this allows Vu-Net to draw the system connections neatly as in the above example but they may be instances where the position of the arrays and complexity of the system means that the network connections cross and the system diagram looks untidy; -

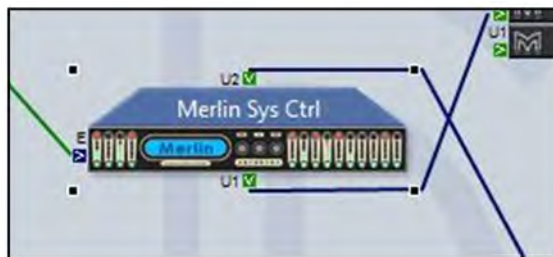

If this is the case, select the Merlin and click on the 'Reverse U-Net ports' button and the port position is reversed in the system diagram hopefully making the network connections look neater; -

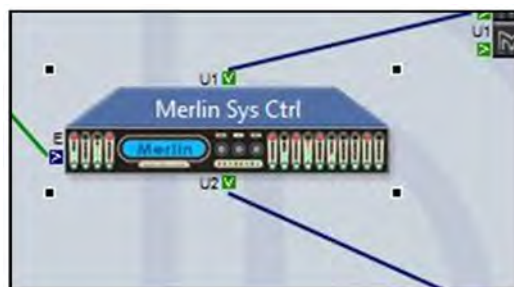

Note: this button reverses the port positions in the system diagram ONLY. It does NOT make any electrical changes to the two U-Net ports, it is purely and simply a graphical change.

## Device Discovery

The normal method for operating a system following completing the system rigging and connection is to run Vu-Net is to run Device Discovery. It is good practice to check your network connectivity, first by using the network icon on the PC task bar which should show connection to your system (it will flag that there is no internet connectivity which can be ignored). Then by going into Preferences and selecting 'Network' and making sure that the Available IP addresses window has an IP address for every Merlin in use with your system. If all is ok you can proceed by clicking on the Discover Devices button; -



Assuming everything is OK with your network connection you will see the following window; -

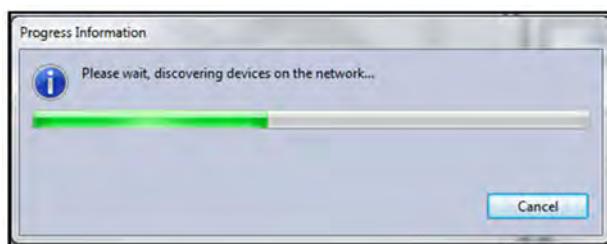

The meter bar will gradually move across until it is completely green and all devices have been found. This may take a few seconds on bigger systems with large arrays of many cabinets.

There are a couple of other windows that may appear at this stage, as well as discovering all devices on the network and identifying their type and IP address, Vu-Net also checks their Firmware to ensure it matches the latest version stored in its internal Firmware database. If it detects an older Firmware version you will see the following window; -

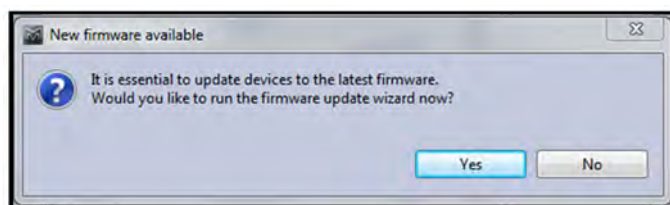

For more detail on Firmware updates please see the relevant Firmware chapter.

Finally, it is possible you may see this window; -



This would indicate a problem up-stream of the Merlin or U-Hub; are the cabinets powered? Are all the network connections made? Is one of the Merlins or U-Hub set to Static IP instead of Dynamic? Can you see two green U-Net LEDs on all devices including the Merlin/U-Hub? If everything is ok try power cycling the Merlin/U-Hub and run Device Discovery again.

Note: It is not essential to have the complete system wired before you run Device Discovery; for example, you may wish to check each array individually as they are rigged so they can be flown out which is perfectly acceptable. Every subsequent press of Device Discovery will find any new elements that have been introduced to the network ignoring those already discovered.

Once Device Discovery has completed its scan you will see the following window; -

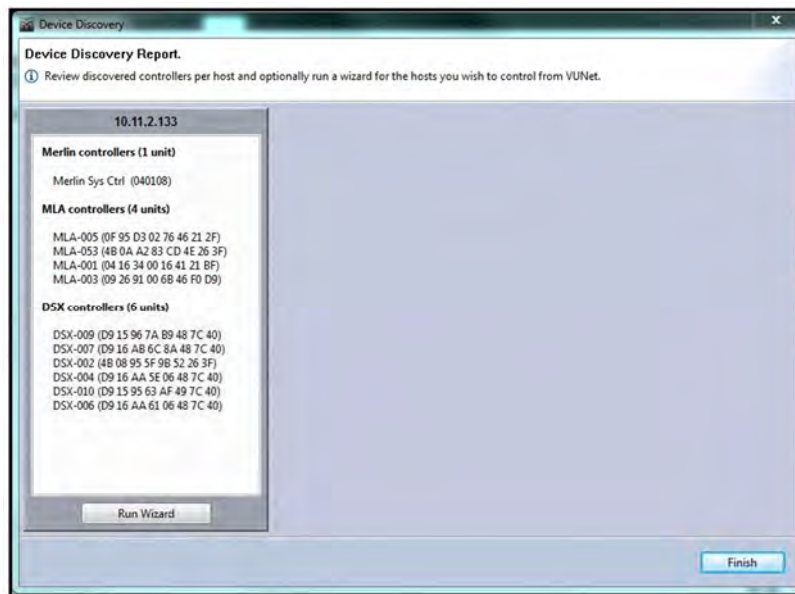

This shows a list of all connected devices found grouped into categories; Merlin Controllers, MLA, MLD, MLX, IKON et cetera. Each individual U-Net network created either by a Merlin, U-Hub or USB connected device (such as an MSX or DD12) will create an individual window with the IP address shown at the top. All devices connected to that U-Net loop will be listed grouped by type.

Next press the 'Run Wizard' button and an individual Wizard will run for all categories, the first will be MLA, MLD or MLA Compact; -

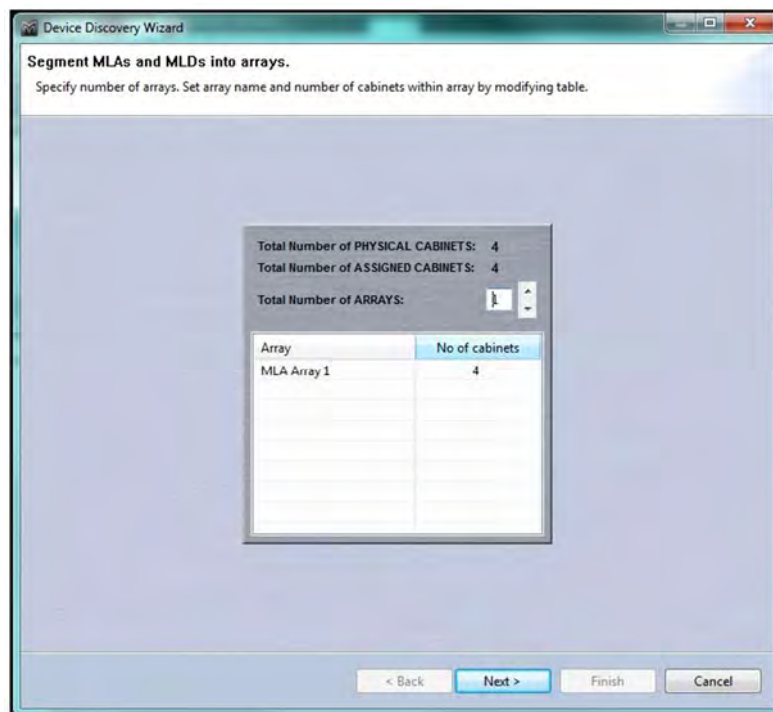

If you have more than one array of each type of cabinet on the same U-Net loop you have the opportunity to divide them into two or more arrays as required. Use the up/down button to select the number of arrays then change the number of cabinets in each array to match what you physically have connected; -



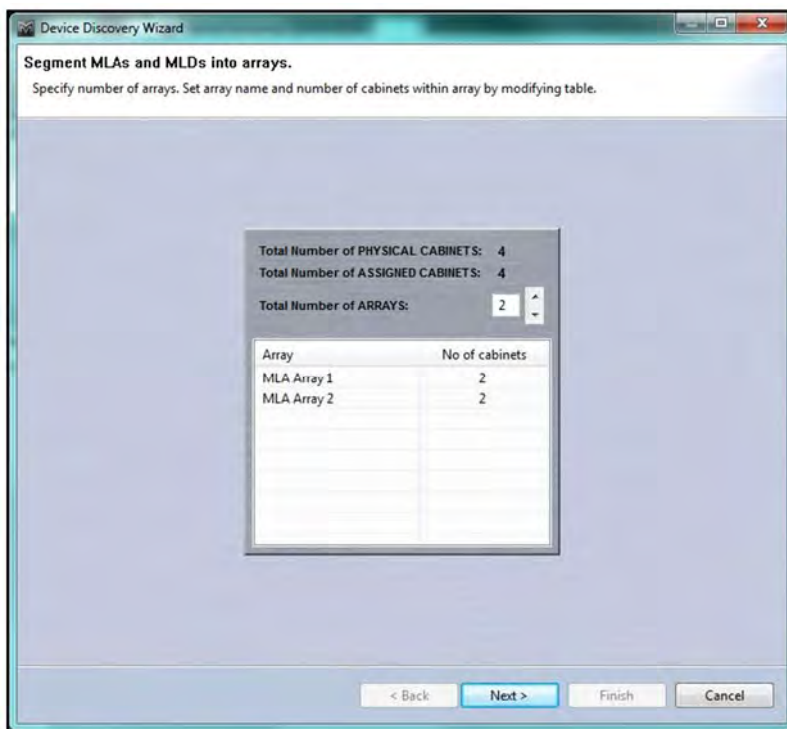

If the total does not match what Vu-Net has discovered the numbers will be flagged in red. Click next and you will see a new window showing the array or arrays; -



If you have more than one array the first step is to use the 'ALL ON' button which will illuminate all the LED badges on the array to check that the Vu-Net arrays match the physical deployment. If there are any errors the cabinets can be dragged and dropped to the correct positions or array. If you only have one array it is still worth flashing all LED's to see the look on the faces of the lighting technicians when they see LED lighting over which they have no control...

Next click the 'BY ONE' button. This will flash the LEDs in sequence from top to bottom. As the U-Net network is bi-directional it is entirely possible that the arrays could have been discovered starting with what is actually the last cabinet in the array. If this has happened you will see the LEDs on the actual cabinets flashing from bottom to top and you MUST click 'REVERSE ORDER' to

get it flashing the right way up. This is essential so that Vu-Net knows that the array is orientated the right way, failure to do this could result in an EQ optimisation being loaded upside down producing an array attempting to produce a coherent, flat response for an audience 30 meters or so up in the air!

Next you will see the following window for any connected MLX or DSX; -

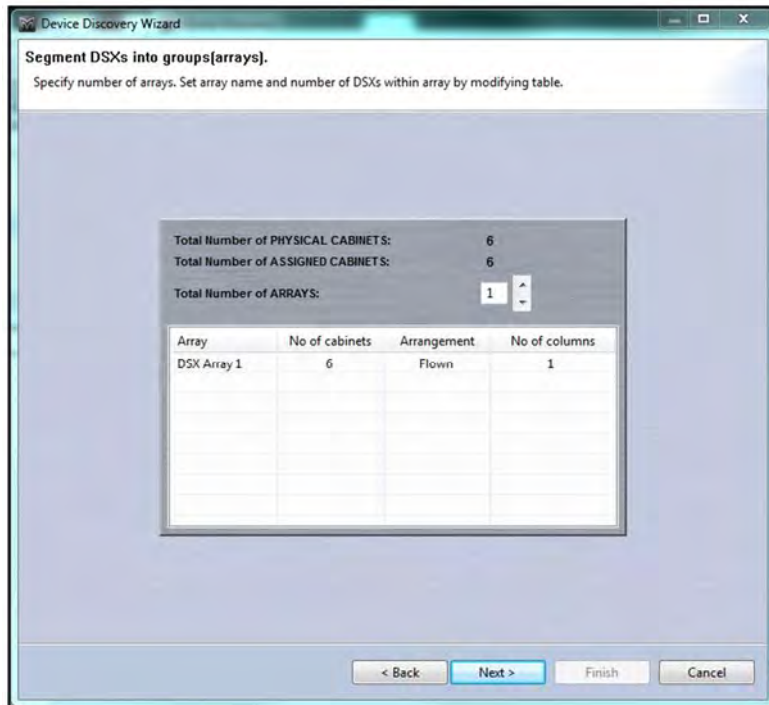

By default the 'Arrangement' will be displayed as 'Flown' therefore the 'No of columns' field will show 1. If you click on 'Flown' it will toggle to 'Ground Stacked' and if this is how your subs are deployed you can select the number of columns to reflect in Vu-Net exactly how they are positioned; -

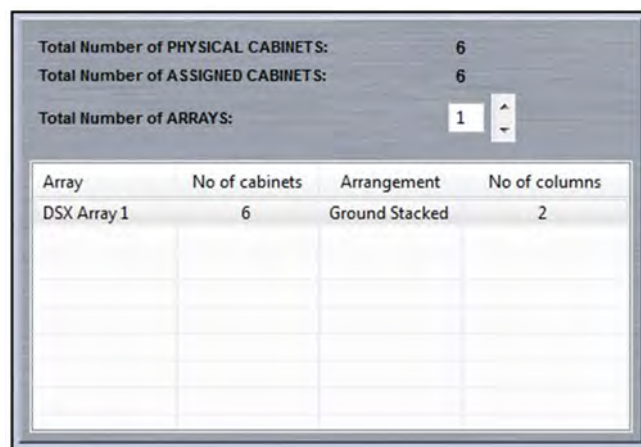

This could even mean making the columns equal the number of enclosures where a broadside array is being deployed; -

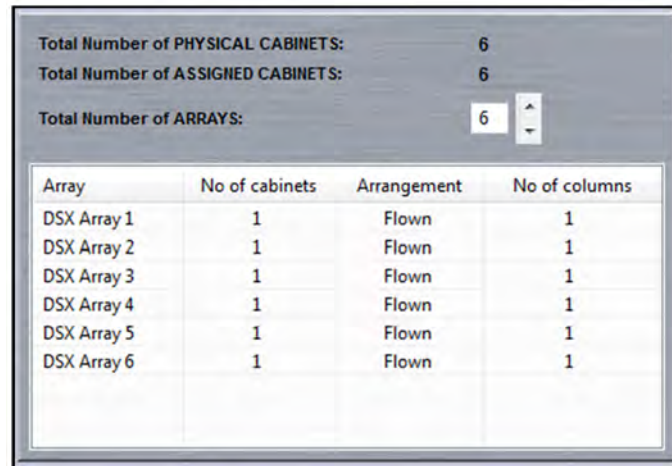

Once you have selected the array configuration select 'Next' and you will see a similar window to the one for MLA, MLD or MLA Compact; -

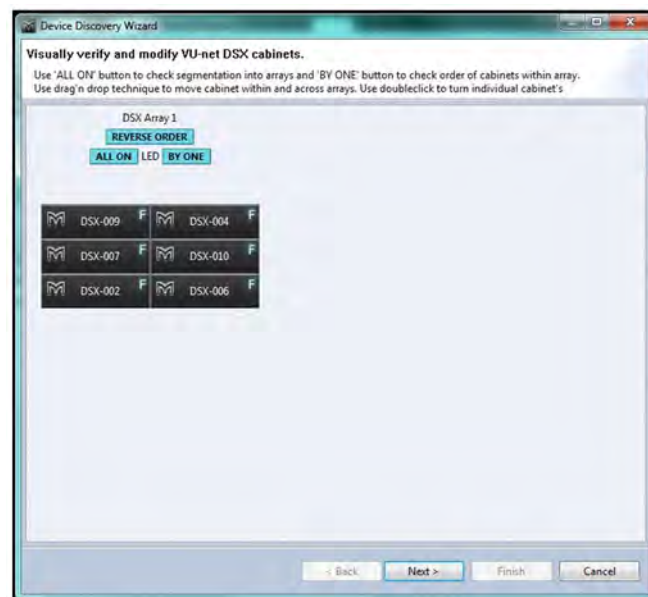

Repeat the process of flashing LED badges to ensure that the cabinets are in the correct order. If any are in the wrong position use drag and drop to reposition them. For a conventional sub stack this may not be vital as the parameters are likely to be identical for all cabinets but for cardioid or broadside arrays it is essential to ensure that they are correct so delay and other parameters applied are directed to the correct cabinet. At this stage you can also change the LED badge to flash on the rear. They are configured for the front LED by default signified by the 'F' on the thumbnails. Double click directly on the badge and you will see the 'F' become a 'B' to signify the back LED. This will flash instead of the front LED when selected. Note that selecting 'B' does not change any internal parameters that may be required for cardioid array operation, it simply changes the LED indicator from the front to the rear for cabinet identification. All parameter changes must still be entered manually; -

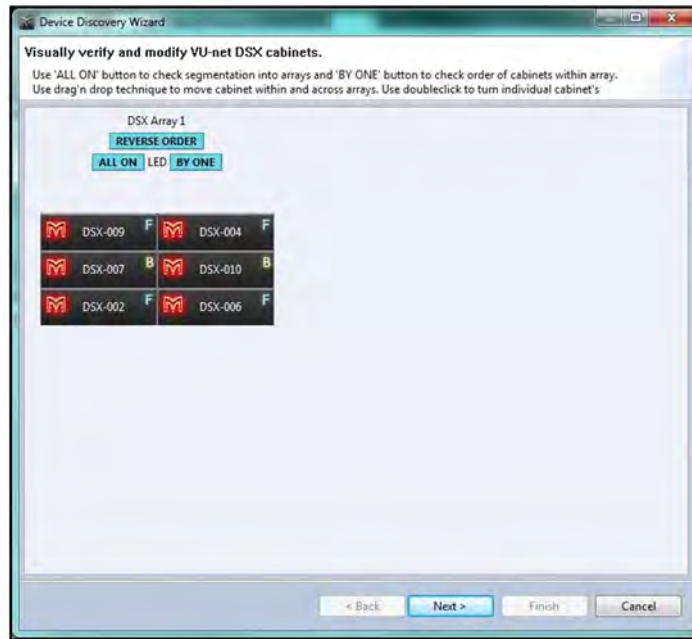

Once you are satisfied with the sub layout click on 'Next' and the synchronisation of all elements on the U-Net loop will commence; -

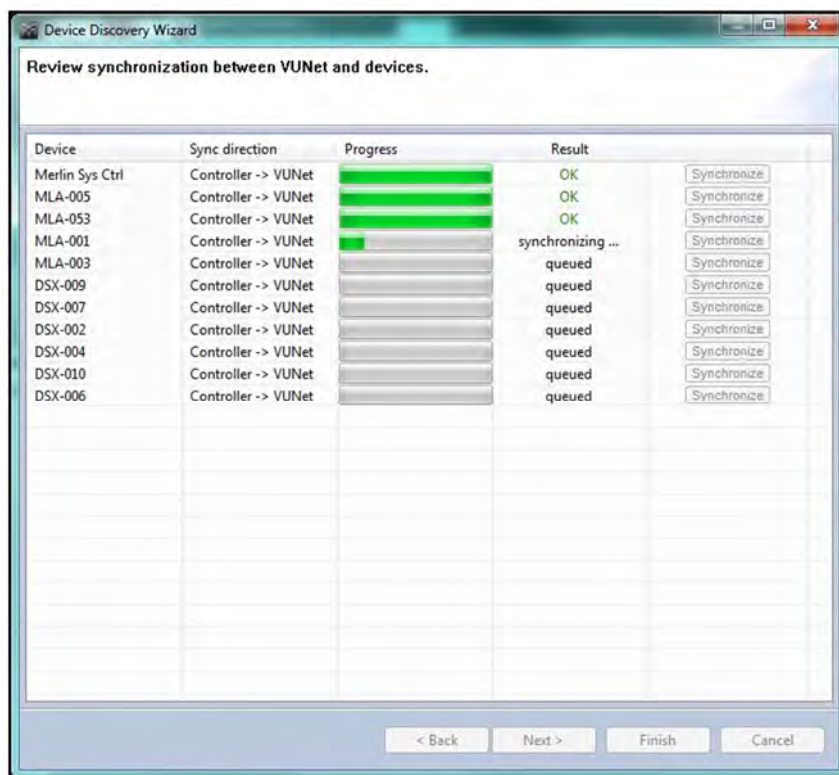

It possible (although unlikely) that one or more element will not synchronise correctly on the first pass in which case there will be a Red 'Fail' in the Result column for that device. If this occurs wait until the rest of the synchronisation is finished and click on the Synchronise button for that device in the extreme right column. The device will attempt a further synchronisation which should result in a success and a green 'OK'. A complete successful synchronisation will appear like this; -

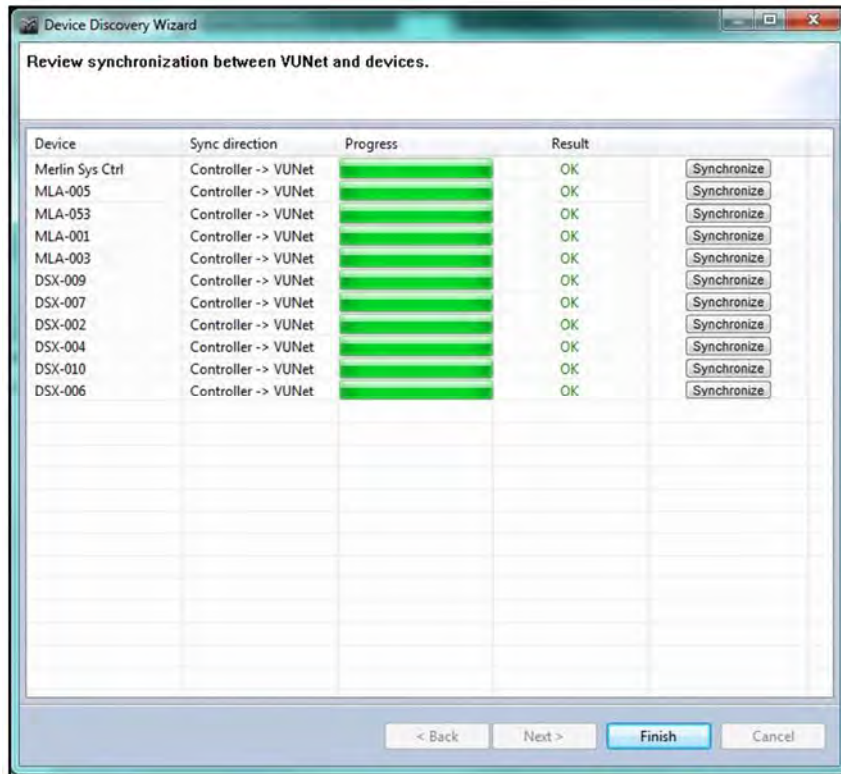

This means that all settings residing in the DSP of all components have been uploaded into Vu-Net so you have a completely accurate picture of exactly how the system is configured on your tablet PC. You can click 'Finish' and a further 'Finish' on the Device Discovery Report window. Repeat the procedure for all connected Merlins which will all have their own U-Net ring of elements.

Once this is completed the Vu-Net workspace will appear as shown; -



### Device Discovery MLA Mini

Device Discovery for MLA Mini is a little more involved as it is necessary to determine the deployment to ensure that the amplifier module is correctly configured, particularly between ground stacked and flown options as the software compensates for the fact that the cabling is done in different directions; for flown systems the cables attach from above so the longest NL4 on the Speaker cable loom going to the lowest cabinet, the opposite is true for ground stacked systems where the speaker loom comes from below with the longest NL4 reaching the upper-most cabinet.

Here is a small MLA Mini system with a pair of MSX Subs and 8 MLA Mini. We have connected via the USB connection on one of the MSX and the two are linked together with U-Net cables; -

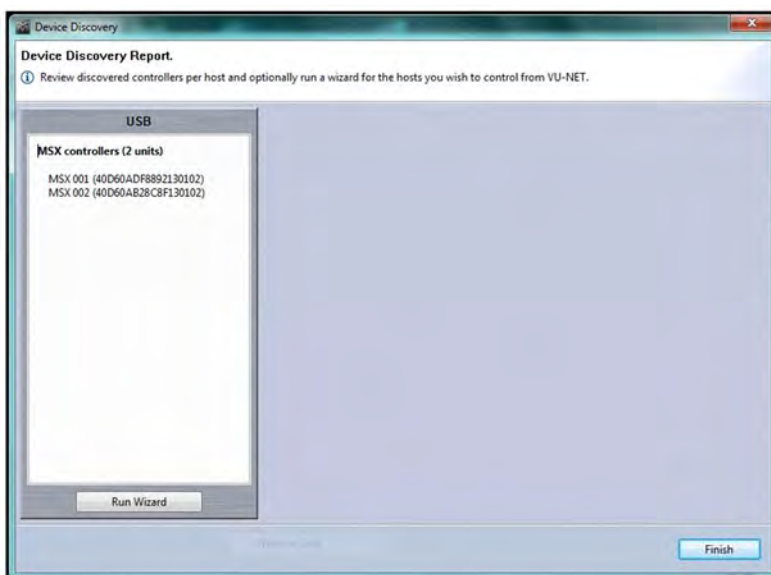

If we click on 'Run Wizard' we see the following Window; -

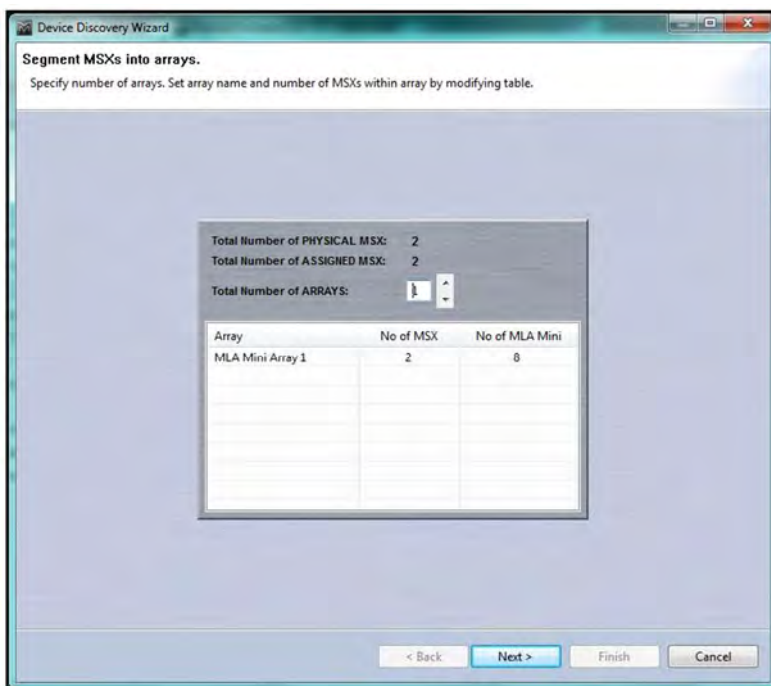

The first task is to determine how many arrays are deployed. By default Display assumes a single array comprising all of the MSX discovered, if the system is actually stereo for example we need to select 2 in the 'Number of ARRAYS' box; -

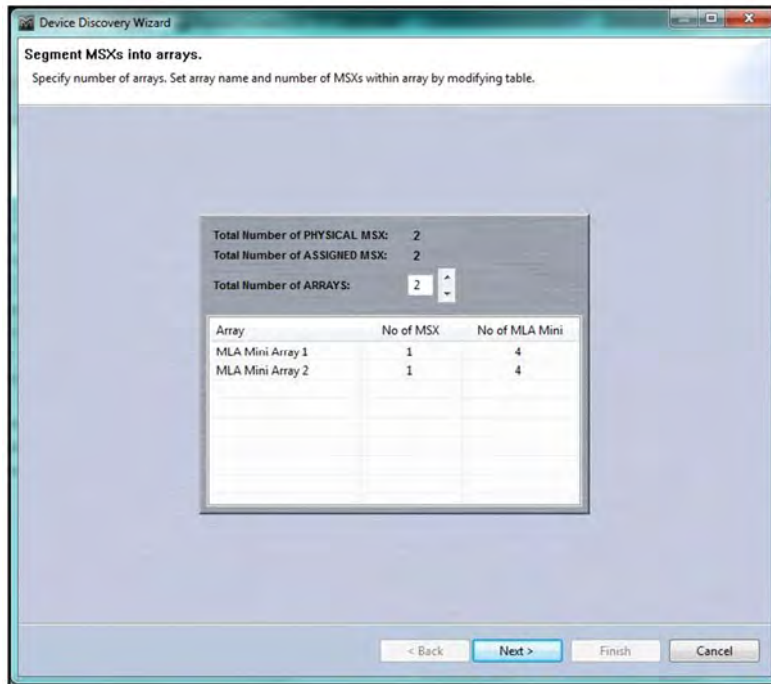

This now shows two arrays each comprising of a single MSX and 4 MLA Mini. Click 'Next' and the next window is where we select the desired deployment; -

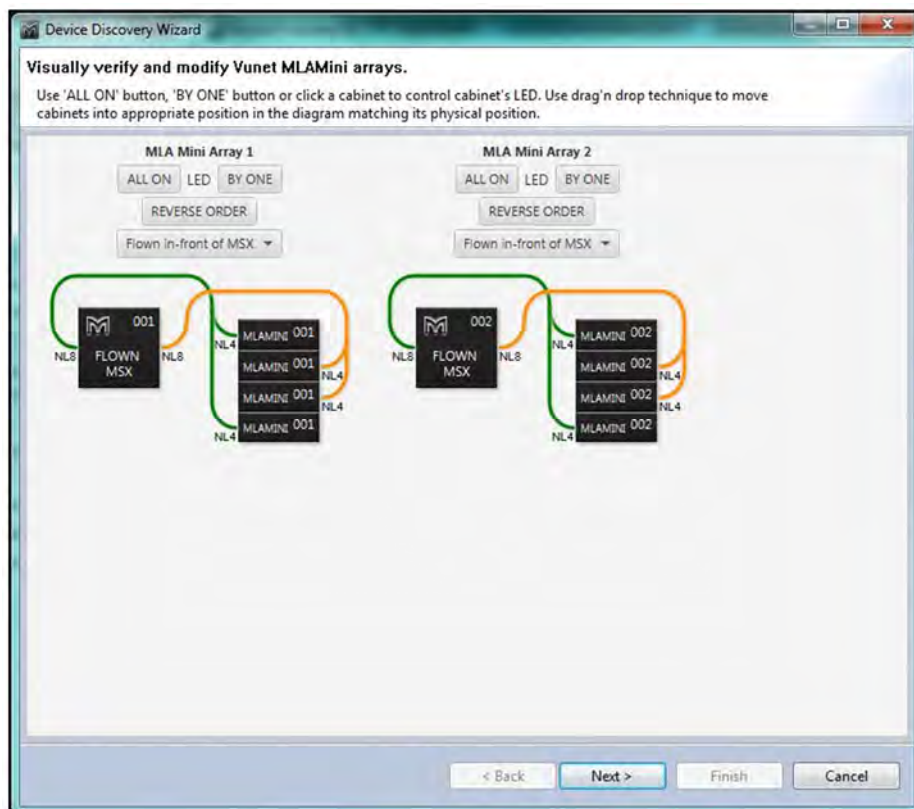

This shows the two MLA Mini array which are deployed in the fault methods of Flown in front of MSX. The drop-down box shows all other options; -

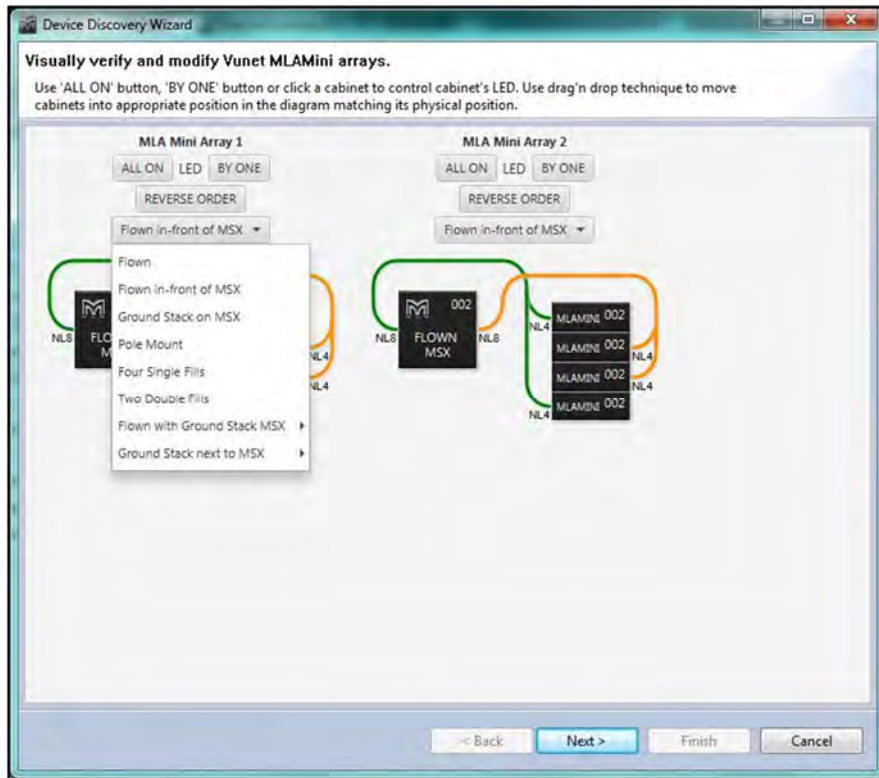

For a larger system the options will change, for example, as the maximum for pole mount is 4 cabinets, 8 or more in an array will remove this option; -

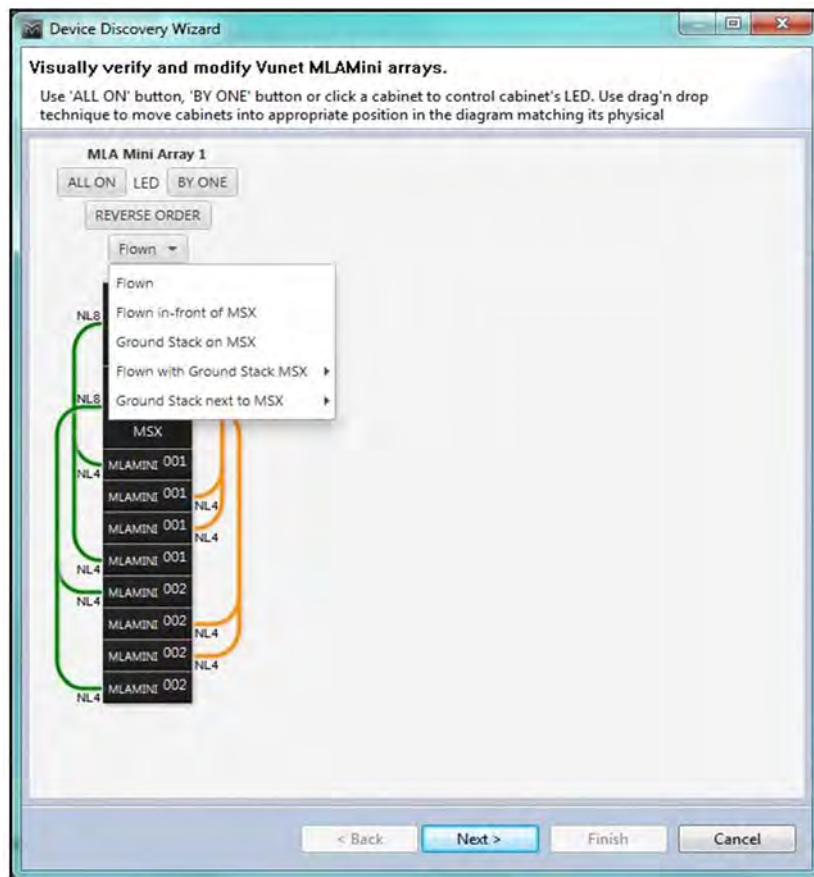



There are however additional options for ground stacked systems of eight or more MLA Mini, the black arrow against these brings out the option for stacking the MSX either horizontally or vertically; -

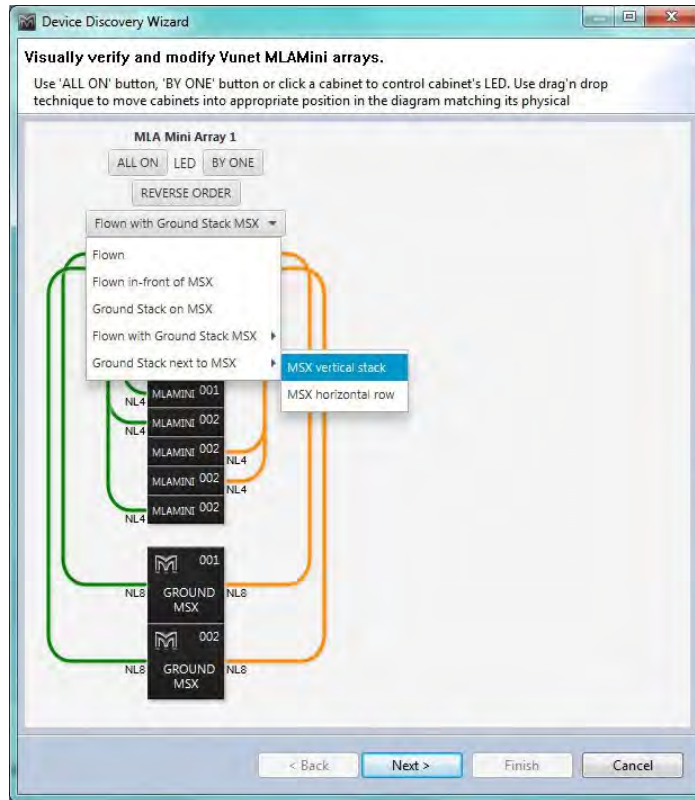

Selecting the various modes will change the array thumbnails accordingly and also importantly shows how the arrays should be cabled. This is particularly important as flown systems are cabled the opposite way to ground stacked with the longest NL4 cable reaching down to the lowest cabinet. For example Flown will appear like so; -

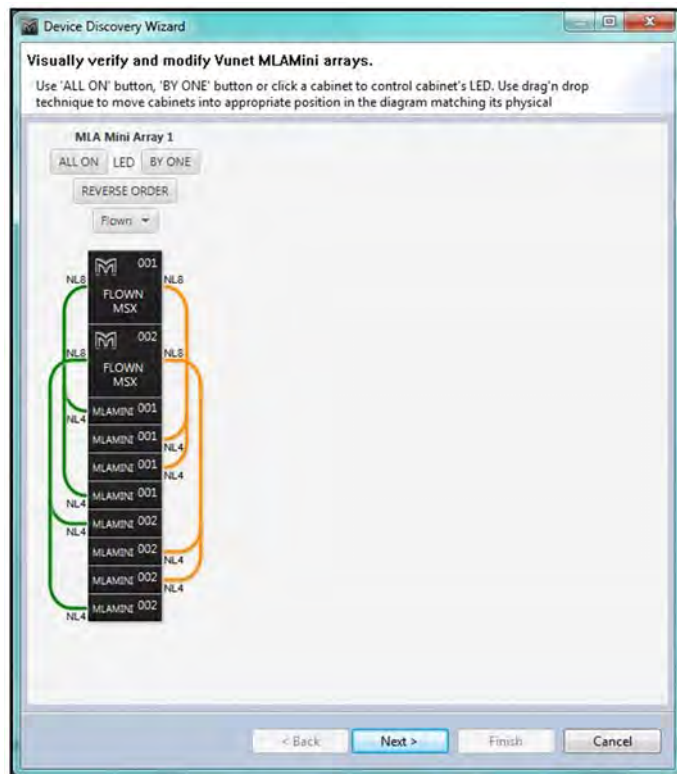

Ground stacked on MSX which is available for up to 8 cabinets appears like this, not the cable which unlike flown has the longer NL4s running up to the top cabinet; -

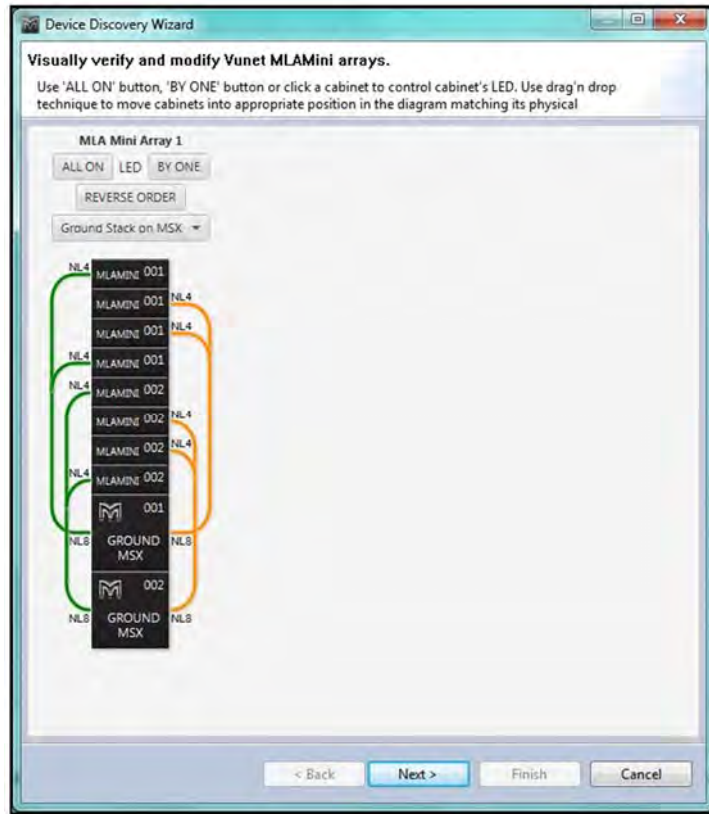

Pole mounted (only available for four cabinets), adds a pole; -

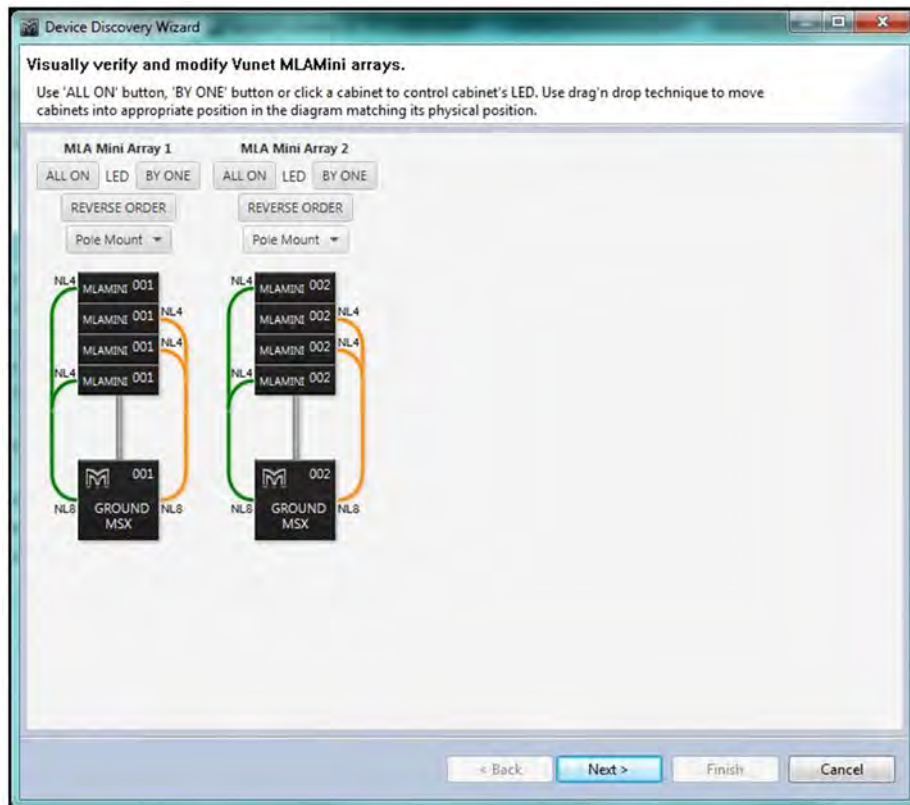

There are two options to use Mini as front fills, either as four single cabinets or two pairs; -

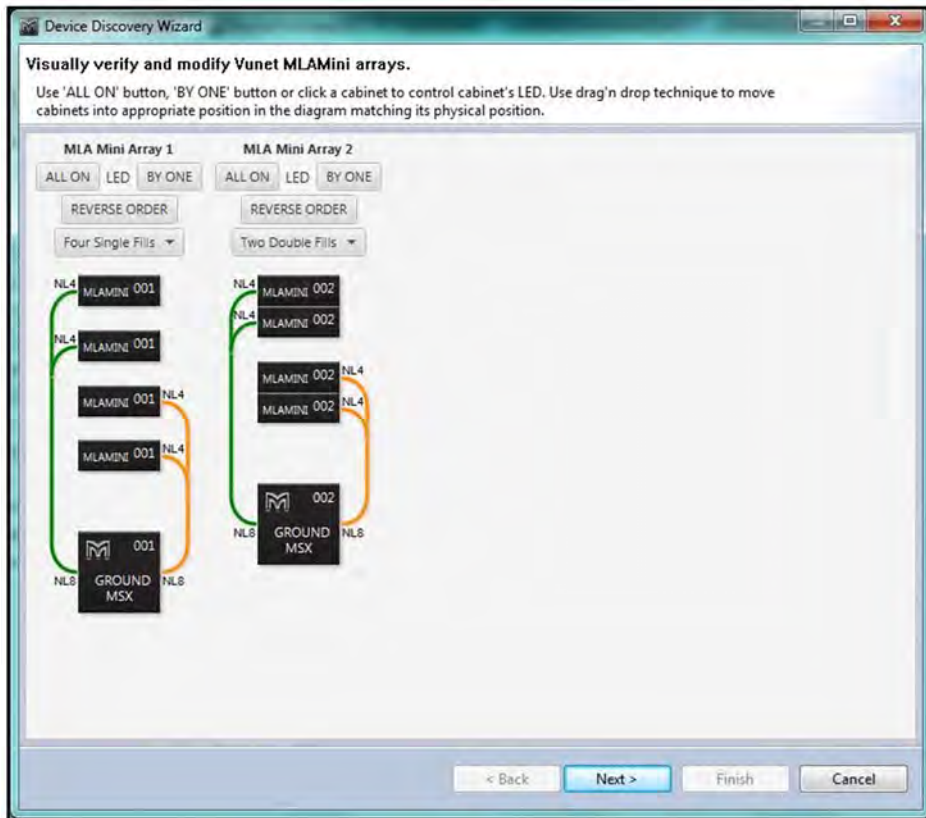

Finally, you can ground stack the Mini next to the MSX; -

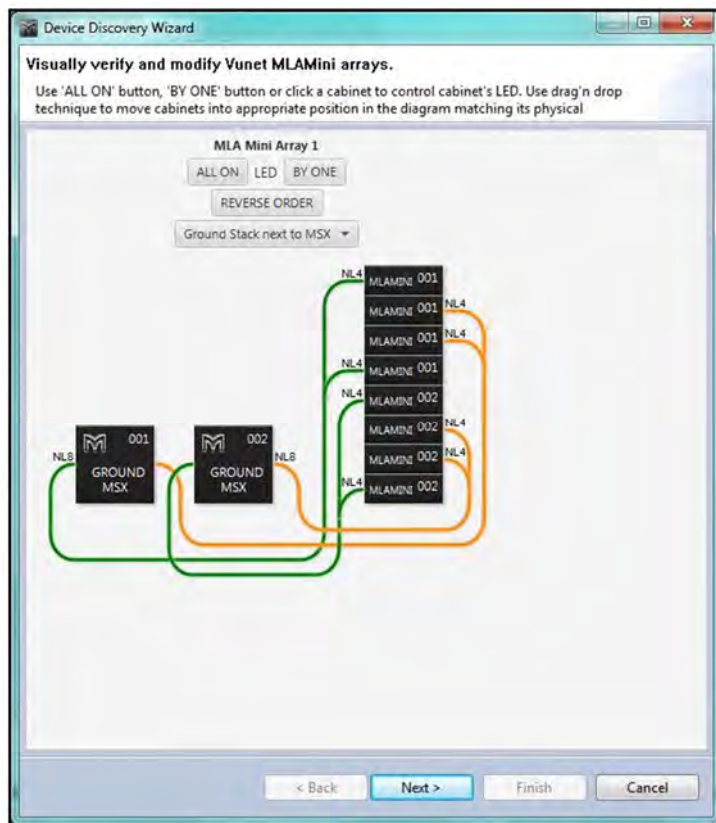

Once you have selected the appropriate deployment you can check the arrays by flashing the LED's on the front of the MSX as with MLA and MLA Compact cabinets. You can select 'ALL ON' to illuminate every cabinet in an array useful for identifying which array is which where two or more are in use, and 'BY ONE' which will flash all MSX in an array sequentially so you can check that they are in the correct order; -

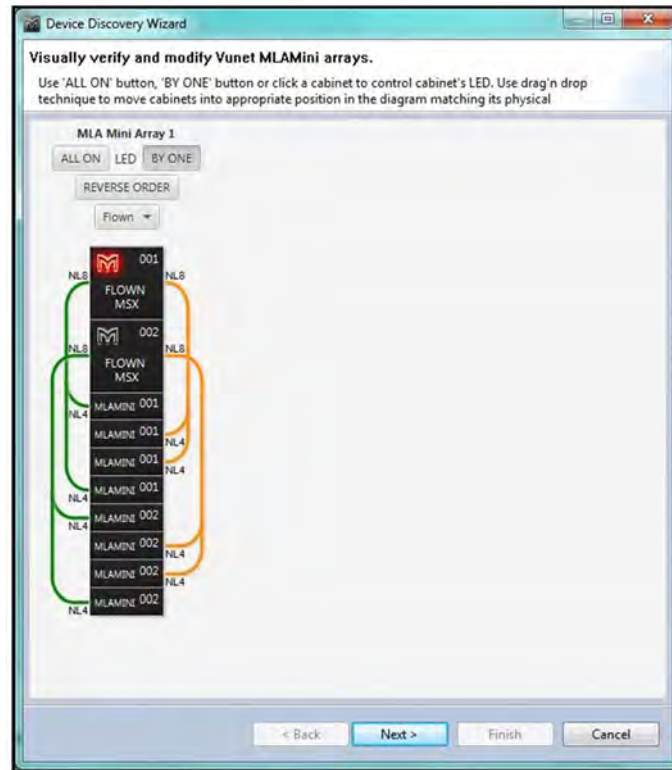

If they are not they can be drag and dropped into the correct positions until the Vu-Net flashing sequence matches the real-world cabinets. Clicking on one MSX will grey out all others until it has been dragged and dropped to the desired position; -

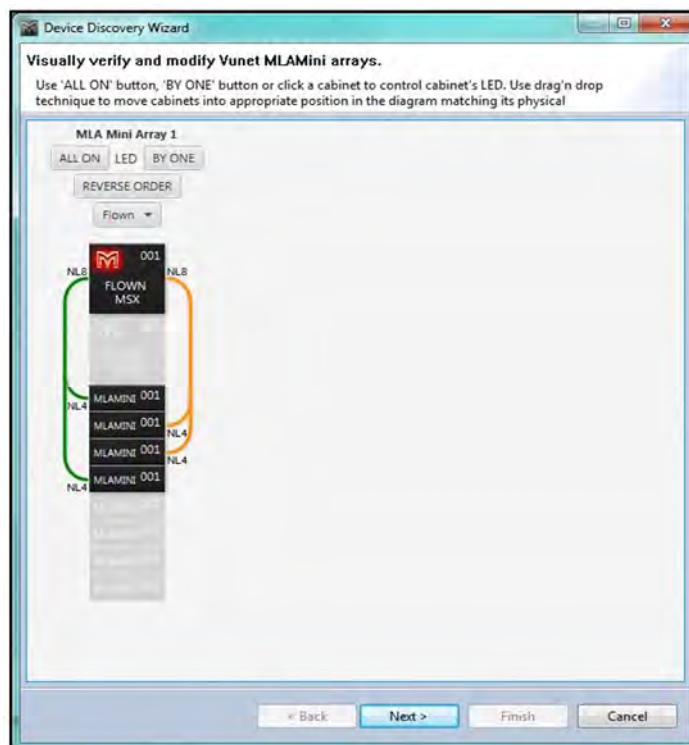

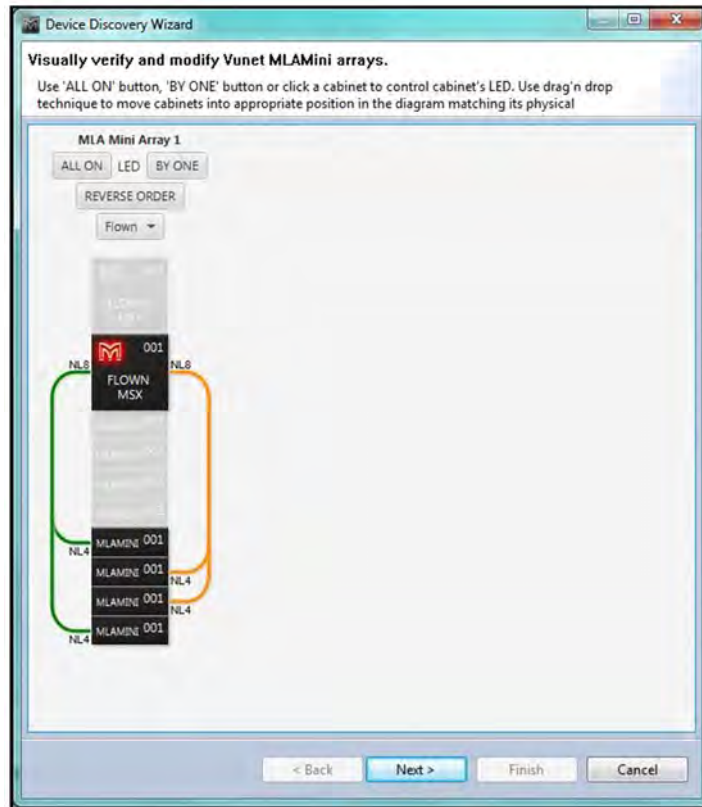

Once the cabinet sequence is corrected you can proceed by clicking next and synchronising the system; -

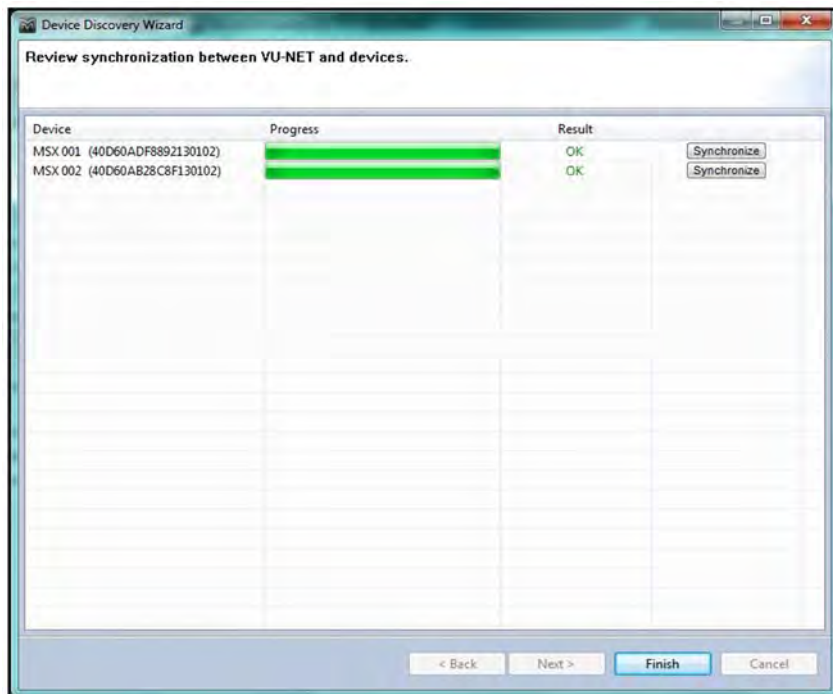

Once complete the arrays will appear on the System Diagram window with the thumbnail representing how you have selected the system deployment. Here is an eight-box system flown from MSX; -

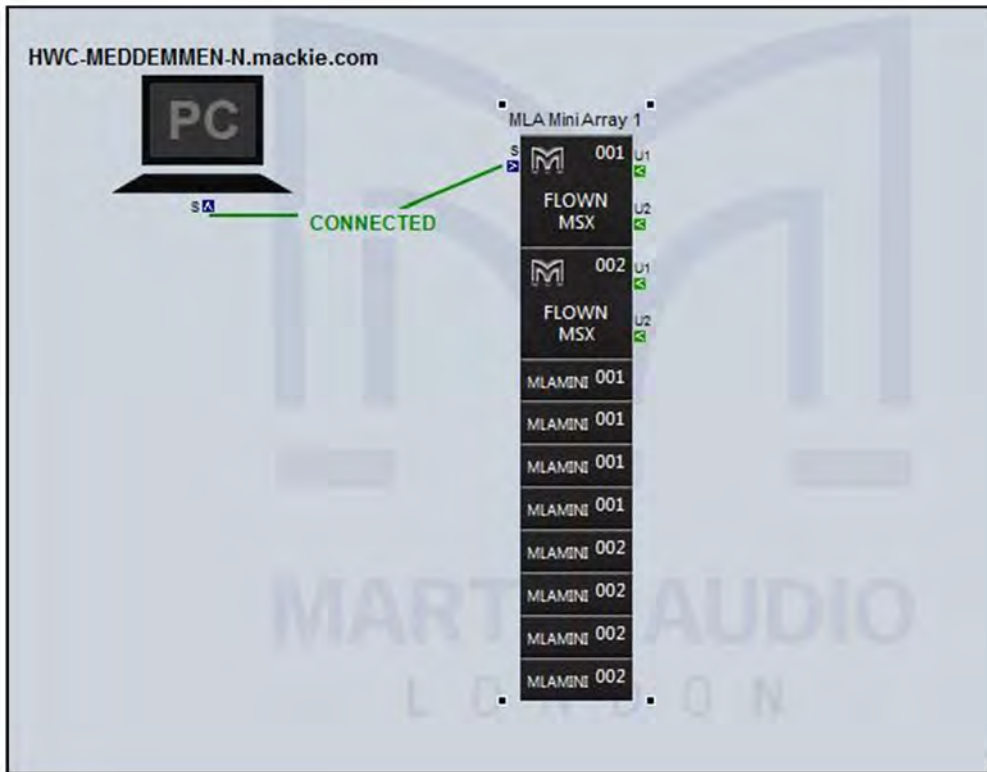

This is a flown system with the MSX flown behind the Mini; -

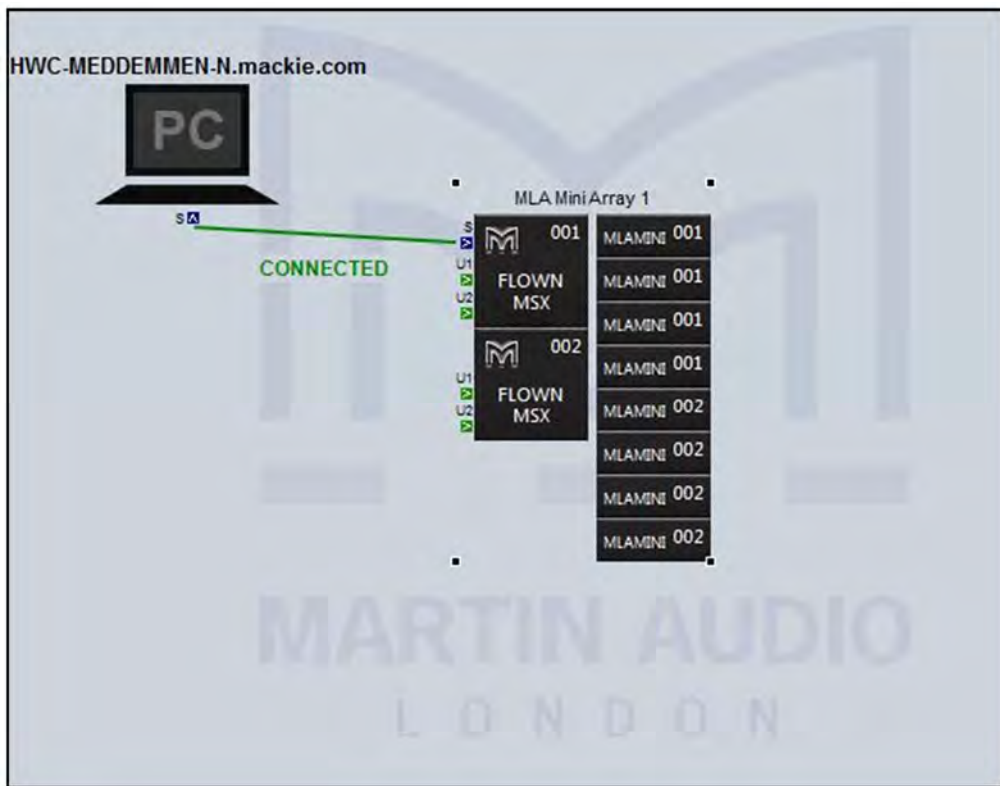

Eight mini ground-stacked on their MSX; -

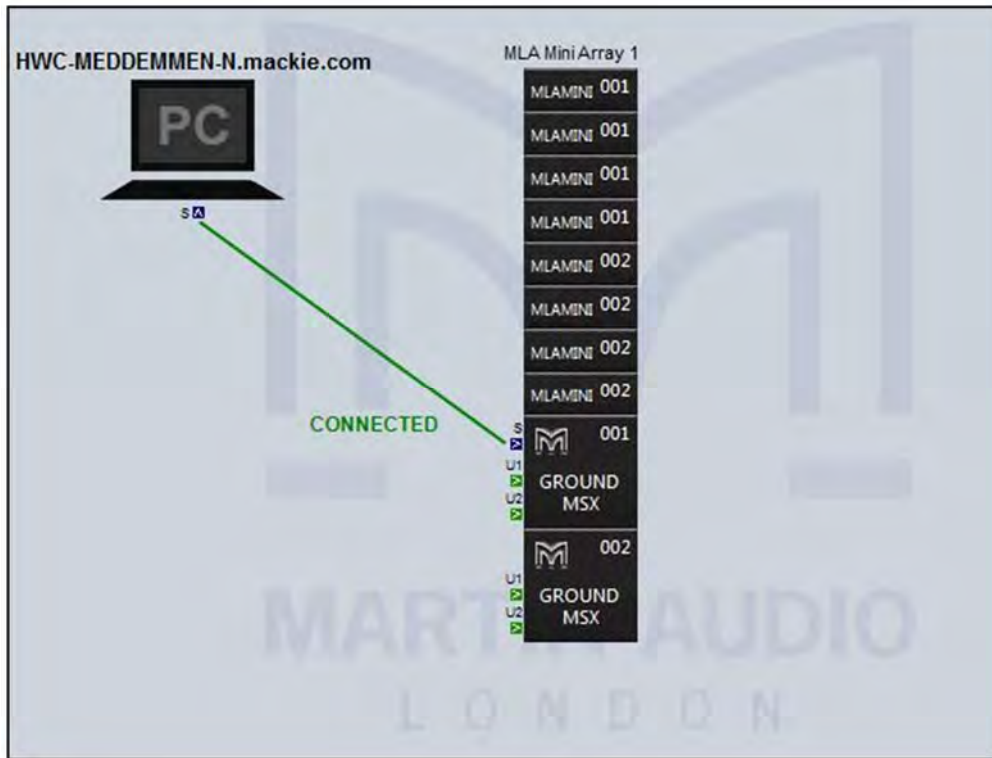

Eight flown Mini with ground-stacked MSX stacked vertically and horizontally; -

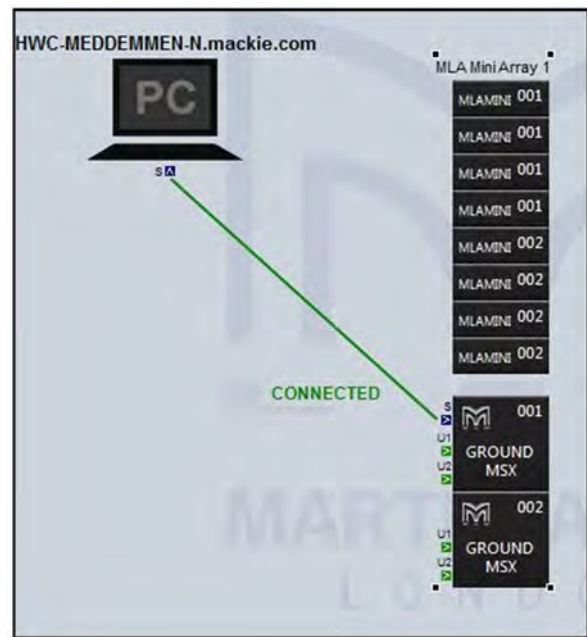
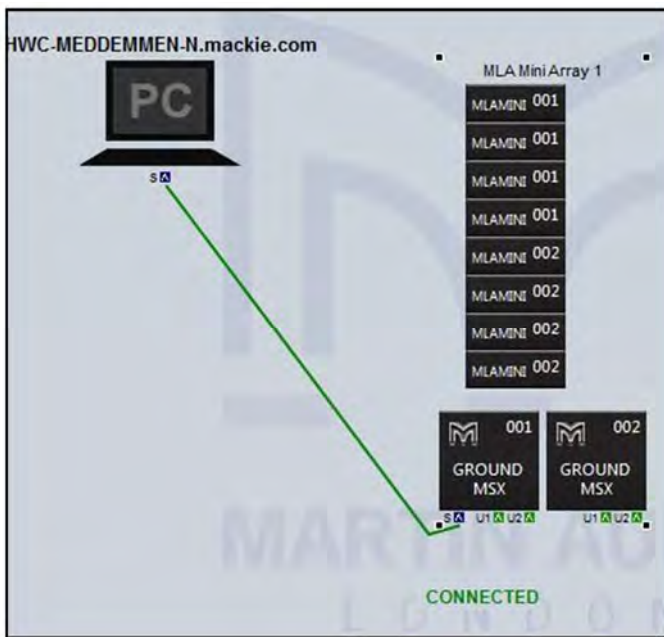

Similarly ground stacked with MSX in both horizontal and vertical modes; -

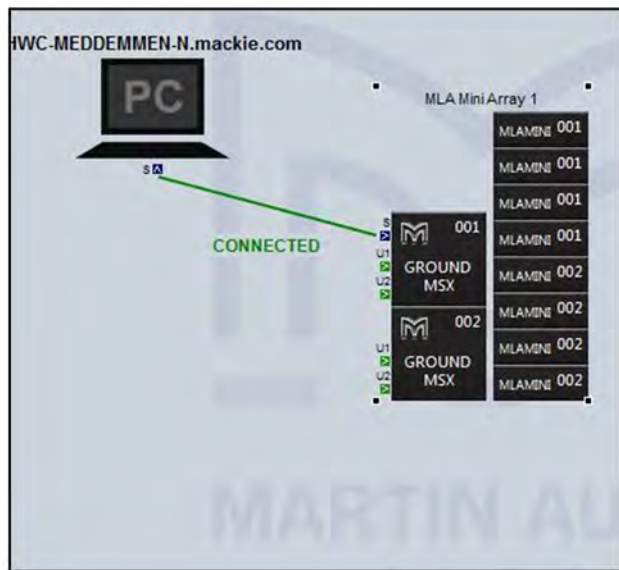
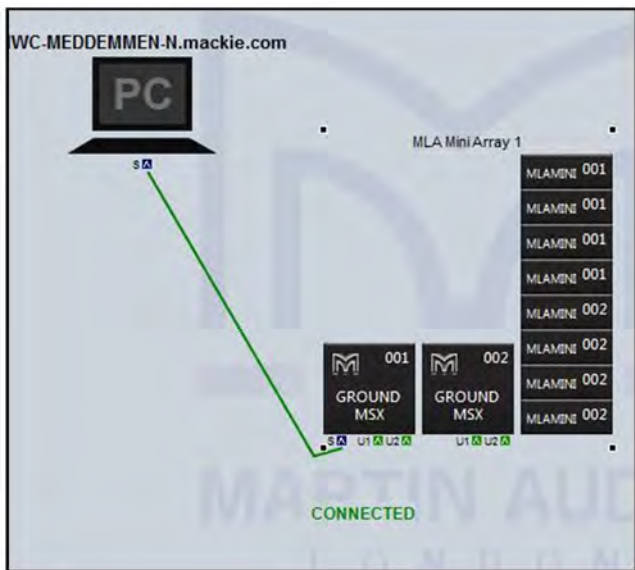



## On line operation

Note the differences from the off line mode of operation. First in the top right corner you can see the indication that the Merlin and connected speakers are on line; -



In the right hand corner we have selected network status and we now see all connected elements showing as Online; -

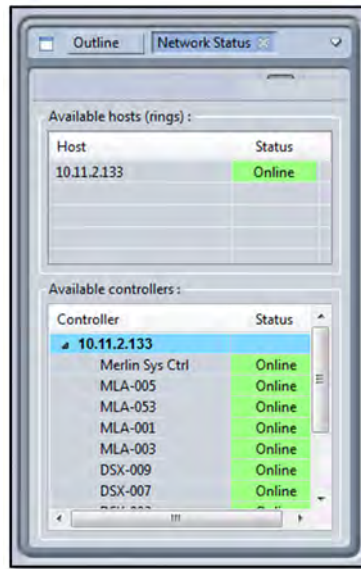

We now have the facility to Disconnect from the system whenever necessary, at the end of the night when a show is finished for example. Click on the 'DISCONNECT' button; -



You will see the Disconnecting System Window appear; -

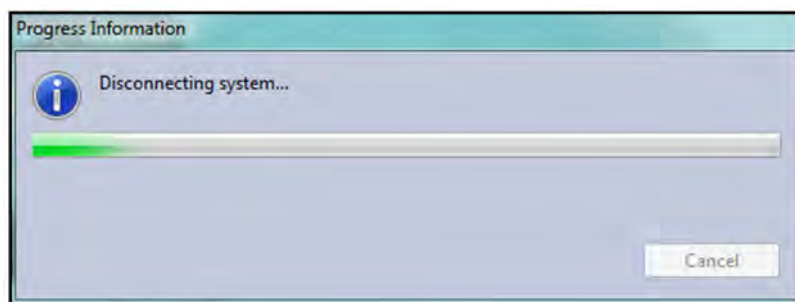

Next you will see the following message; -

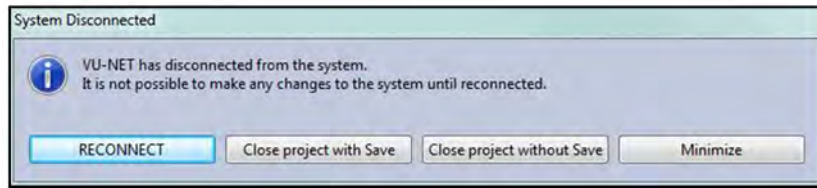

The Vu-Net Window will now appear as follows, note that the connection between PC and Merlin is showing as 'Disconnected' and the system in the Diagram window is greyed out. As the pop-up window mentions, it is not possible to make any changes to the system whilst the system is in this state. We recommend using disconnect and re-connect when changing from a wi-fi to a wired connection for example when set-up is complete before the show start; -

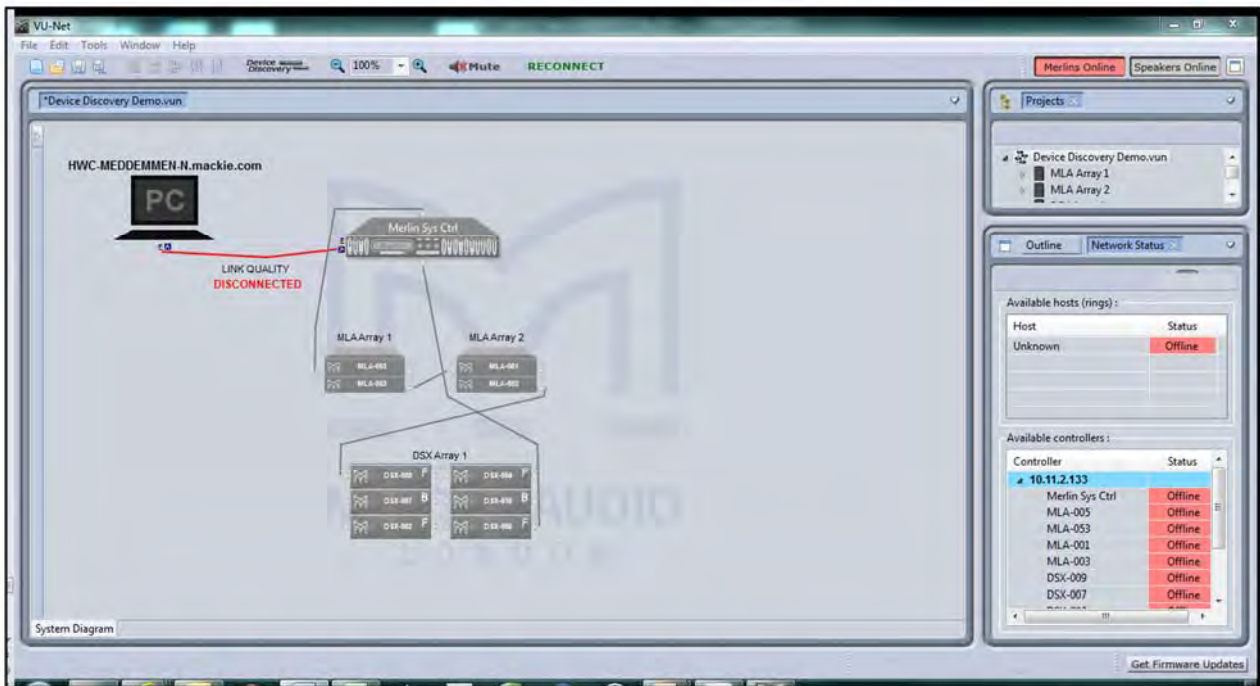

The 'DISCONNECT' button is now a 'RECONNECT'; -



And a click will restore the connection to the system. If the project has been saved, when re-opened you will be prompted to re-connect immediately. Once reconnected you will see the following message; -

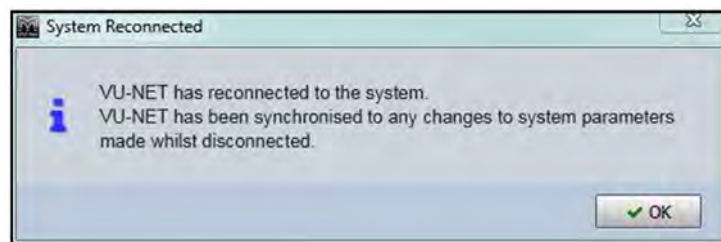

As you can see, the System diagram detects and draws all network connections. Note that Ethernet connections from PC to Merlins are shown as a line regardless of whether it is a hard-wired cable, copper link or wireless connection. The U-Net ports

on individual devices also show the network integrity. Good connections will show as a green U1 and U2 port. A faulty or missing connection between devices in an array will be shown as either a grey (no connection) or a red (connection with network errors) U-Net port. By hovering your mouse over a port displaying an error you will see details outlining the nature of the issue; -



In most cases this is not critical as a U-Net topology is a redundant ring so if there is a break in the network connection, every device will still remain on line as the A cabinet or array off-line will appear in red, an individual off line cabinet will be shown at the position in the array; -

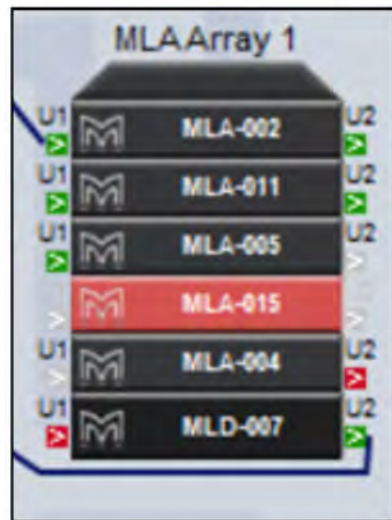

The network is monitored in real time so as soon as any network or cabinet issues have been resolved the connections and cabinets will return to the regular colour scheme; -



### Right-Click menu

Access to functions for Vu-Net enabled products are achieved in two ways; double clicking or right clicking, first we will look at the options available when selecting an element with a right mouse click as there are some configuration options that you may need to select first from this page. The right click menu varies according to the device selected, ; -

#### Merlin



**Open** will open the full configuration page in exactly the same way as a double click

**Load** offers two options, either load a saved Merlin Configuration file created using the Save function, or load a Preset file which will import a binary file created in XTA's Library Manager.

**Save.** There are three options, 'All', 'Inputs' and 'Outputs'. These will save the Merlin configuration as a Merlin \*.meq file in a location of your choice on your hard drive. As the options suggest, 'All' will save the entire Merlin configuration, 'Inputs' just the input PEQ and delays and 'Outputs', all parameters from the output channels ignoring the inputs. The \*.meq file can be saved and re-used in future projects or distributed to other MLA partners for use with other systems. It is loaded using the 'Load' function.

**Synchronize** is a manual synchronise between the PC and connected device. This happens automatically when a device is first discovered.

**Disconnect/Reconnect** Allows you to disconnect a single Merlin from the network turning it red in the Vu-Net window.

**Rename** allows you to give the Merlin a name to suit the event and location if desired. Function key F2 is a shortcut to this option.

**Select All** will select all components in the system design. The keyboard shortcut for this is Ctrl + A.

**Delete** Removes the Merlin from the project.

## U-Hub

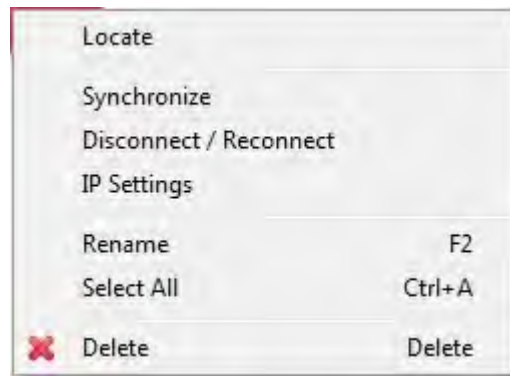

**Locate** will flash the front panel LEDs to make it easy to identify which U-Hub you are adjusting

**Synchronize** is a manual synchronise between the PC and connected device. This happens automatically when a device is first discovered.

**Disconnect/Reconnect** Allows you to disconnect a single device from the network turning it red in the Vu-Net window.

**IP Settings** This opens a dialogue box to switch between dynamic IP assigned by a DHCP Server, and Static IP that you enter yourself; -

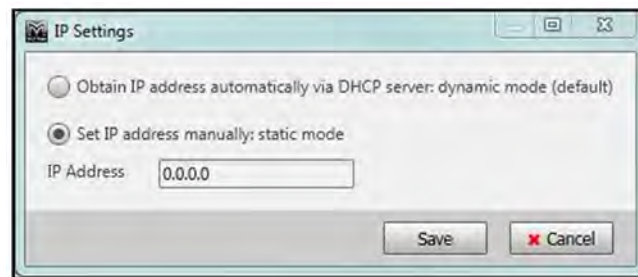

**Rename** allows you to give the U-Hub a name to suit the event and location if desired. Function key F2 is a shortcut to this option.

**Select All** will select all components in the system design. The keyboard shortcut for this is Ctrl + A.

**Delete** Removes the U-Hub from the project.

## MLA & MLA Compact

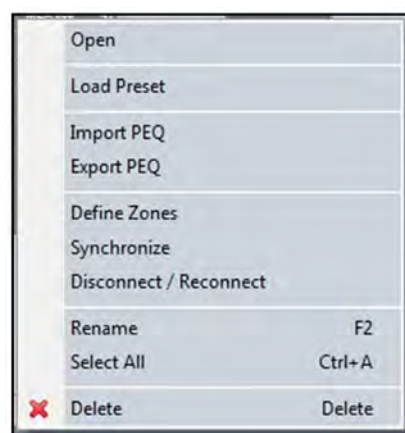

**Open** will open the full configuration page in exactly the same way as a double click

**Load Preset** will open the preset selection panel for the array

**PEQ** has two options, Import and Export. As we will see, it is possible to tailor the EQ of an array to suit personal preference. This is in addition to the array optimisation from Display 2.1 which will equalise the system to suit the response requested in the design. If there is a particular sound required for a style of music or requested by a sound engineer, the curve can be stored as a file and recalled for any future shows using these commands. Using the house EQ will be covered later in this chapter.

**Define Zones** is used to zone the array up to a maximum of six zones.

**Synchronize** is a manual synchronise between the PC and connected device. This happens automatically when a device is first discovered.

**Disconnect/Reconnect** Allows you to disconnect either the entire array from the network turning it red in the Vu-Net window, or individual array elements using this window; -



**Rename** allows you to give the array a name to suit the event and location if desired. Function key F2 is a shortcut to this option.

**Select All** will select all components in the system design. The keyboard shortcut for this is Ctrl + A.

**Delete** Removes the Array from the project.

## MLA MINI

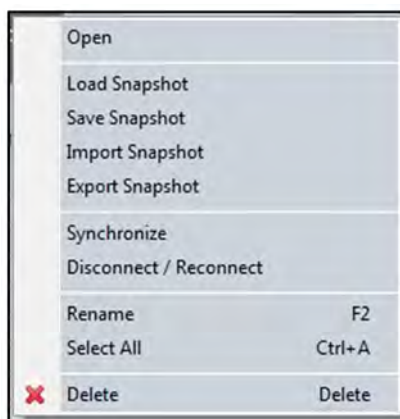

**Open** will open the full configuration page in exactly the same way as a double click

**Load Snapshot** will open the Load Snapshot Window.

**Save Snapshot** allows you to store the configuration that you have created to a free user snapshot location.

**Import Snapshot** allows you to import a snapshot stored as a file.

**Export Snapshot** is an option for storing the configuration that you have created as a file on your PC so it can be used in other cabinets of the same type in the project or in the future with other systems.

**Synchronize** is a manual synchronise between the PC and connected device. This happens automatically when a device is first discovered.

**Disconnect/Reconnect** Allows you to disconnect either the entire array from the network turning it red in the Vu-Net window, or individual array elements using this window; -

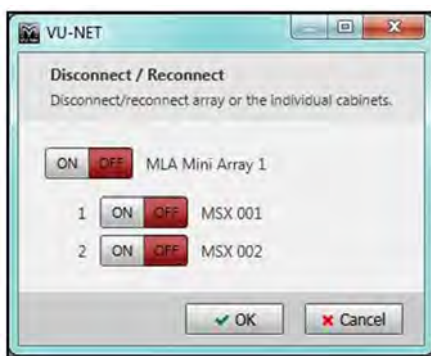

**Rename** allows you to give the MLA Mini array a name to suit the event and location if desired. Function key F2 is a shortcut to this option.

**Select All** will select all components in the system design. The keyboard shortcut for this is Ctrl + A.

**Delete** Removes the Array from the project.

## DD12 & PSX

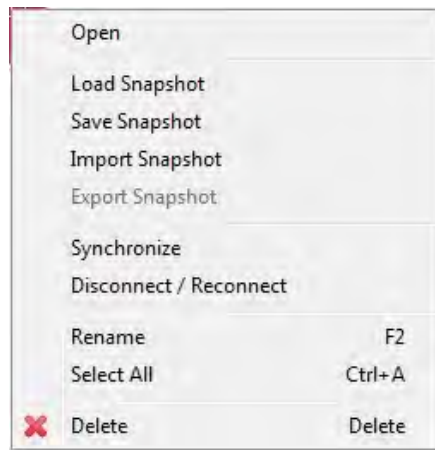

**Open** will open the full configuration page in exactly the same way as a double click

**Load Snapshot** will open the Load Snapshot Window.

**Save Snapshot** allows you to store the configuration that you have created to a free user snapshot location.

**Import Snapshot** allows you to import a snapshot stored as a file.

**Export Snapshot** is an option for storing the configuration that you have created as a file on your PC so it can be used in other cabinets of the same type in the project or in the future with other systems.

**Synchronize** is a manual synchronise between the PC and connected device. This happens automatically when a device is first discovered.

**Disconnect/Reconnect** Allows you to disconnect a single device from the network turning it red in the Vu-Net window.

**Rename** allows you to give the DD12 or PSX a name to suit the event and location if desired. Function key F2 is a shortcut to this option.

**Select All** will select all components in the system design. The keyboard shortcut for this is Ctrl + A.

**Delete** Removes the DD12 or PSX from the project.

## CDD-LIVE & SXP



**Open** will open the full configuration page for all CDD-Live or SXP speakers in the project in exactly the same way as a double click



**Open selected** Will just open just the CDD-Live or SXP that have been selected

**Open Selected Zones** This will open all CDD-Live or SXP in the same zone(s) as the CDD-Live or Lives that have been selected.

**Load Snapshot** will open the Load Snapshot Window.

**Save Snapshot** allows you to store the configuration that you have created to a free user snapshot location.

**Import Snapshot** allows you to import a snapshot stored as a file.

**Export Snapshot** is an option for storing the configuration that you have created as a file on your PC so it can be used in other cabinets of the same type in the project or in the future with other systems.

**Synchronize** is a manual synchronise between the PC and connected device. This happens automatically when a device is first discovered.

**Disconnect/Reconnect** Allows you to disconnect a single CDD-Live or SXP from the network turning it red in the Vu-Net window.

**Rename** allows you to give the CDD-Live or SXP a name to suit the event and location if desired. Function key F2 is a shortcut to this option.

**Select All** will select all components in the system design. The keyboard shortcut for this is Ctrl + A.

**Delete** Removes the CDD-Live or SXP from the project.

## Renaming

Selecting 'Rename' from the right-click menu or pressing F2 with a device selected brings up the following window; -

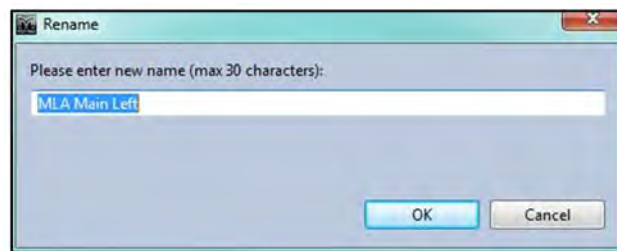

Type the required name which can be up to 30 characters. Press OK and the name will be shown on the device label in the System Diagram, Master Overview and when that device is selected.

## Presets & Snapshots

We use two distinct terms for stored parameters when referencing recalling system memories within devices in Vu-Net but there are clear differences between a Snapshot and a Preset. "Snapshot" in common with digital mixing console terminology, is a memory which saves every setting of the devices at the moment that "Store" is pressed. This includes all gain, mute, input routing, EQ, phase and time delay. Any parameter that can be modified will be stored as part of a Snapshot

Presets are unique to the Multicellular products and are the optimised files created using Display 2 which enable MLA, MLA Compact, MLA Mini, Wavefront Precision and O-Line to deliver the coverage exactly as specified by the system technician when the system was designed in Display. A Preset or a number of presets are uploaded to the system using the Preset Loader tool and are recalled as shown. Recalling a Preset only recalls the optimisation in the User Preset location. It does not alter any other parameter that may have been modified such as input gain or parametric EQ.

## Loading Presets

As we will see, system configurations for MLA and MLA Compact including different optimisations can be stored as Presets. These are stored in the DSP of each cabinet once uploaded so recalling is a simple network instruction to load whichever snapshot has been selected. It is therefore quick to do and could easily be done between acts at a festival for example. This could be extremely useful if you have done a number of optimisations for an outdoor space with different environmental conditions to compensate for the variation in air absorption during the day as the conditions change from bright sunlight to cool evening. If you need to

save or select presets for several arrays simultaneously you would select the necessary arrays as already described, then use the Load or Save presets commands in the Edit menu, however if you just need to select presets in a single array you can do so using the menu functions available by right clicking. Selecting Recall Preset will bring up the following Window; -



(Note that this is an off line array which is why the Presets are showing "Undefined"). Preset A is a factory default with no eq, phase or gain modifications. This is useful to load as a system test option so when listening to pink noise through individual cells it is easier to hear and differences between drivers. It is also valuable as an emergency setting, say you had a catastrophically late load-in and don't have time to create an optimisation file you can recall preset A and use the system essentially as a standard line array. You can easily upload an optimised Preset at a later stage, see the chapter on Preset Uploading.

Presets are loaded by clicking on the desired Preset number after which a window will show the upload progress ending with 'preset load success' Depending on the size of the array and complexity or the optimisation this may take anything from a few seconds to 10 or 15.

### Defining Zones in MLA and MLA Compact

By default every array is discovered as a single zone but from this menu any array can be divided into up to six zones which can all be equalised and have their gain trimmed independently. Perhaps the most common use for this is to zone an MLD independently from the rest of the array as there is often a requirement for the near-filed coverage to have quite different equalisation. As an example, we will take a twelve-cabinet array and divide it into three zones; the MLD, the lower six MLA and the top five MLA.

First click on 'Define zones' in the right-click menu. Will see the following window; -

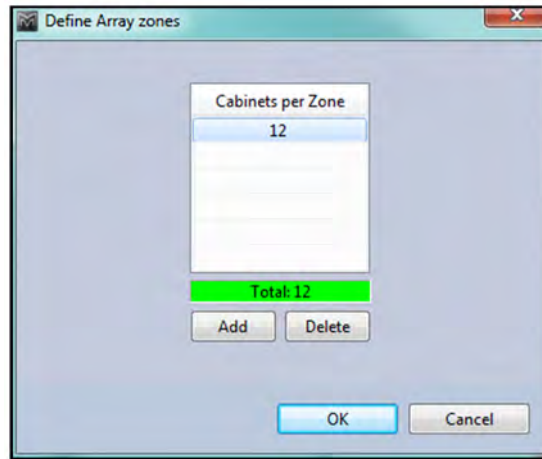

This shows a single zone of twelve cabinets, the total at the bottom is shown in green because it equals the numbers in all zones. We now click 'Add' and an additional zone is added of one cabinet below the first. The upper zone has its quantity reduced to eleven to maintain the total of twelve; -

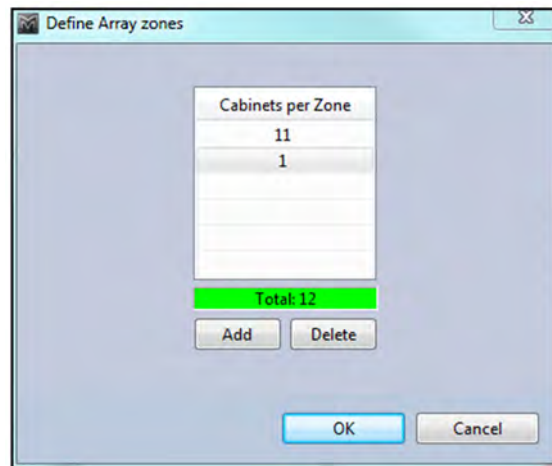

Click 'Add' a second time, it is necessary to create the desired number of zones first and then modify the quantities in each zone. New zones are always added below the previous and the position in which they are shown corresponds to the physical position in the array; -

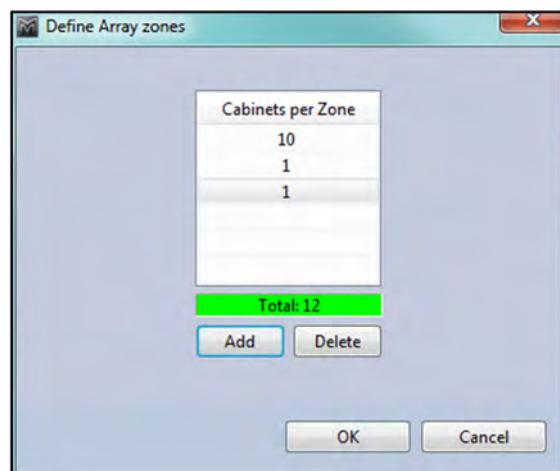

We want our top zone to consist of five MLA to click on the 10 shown in the top array and type "5". The quantity of cabinets is no longer 12 so the total is flagged red; -

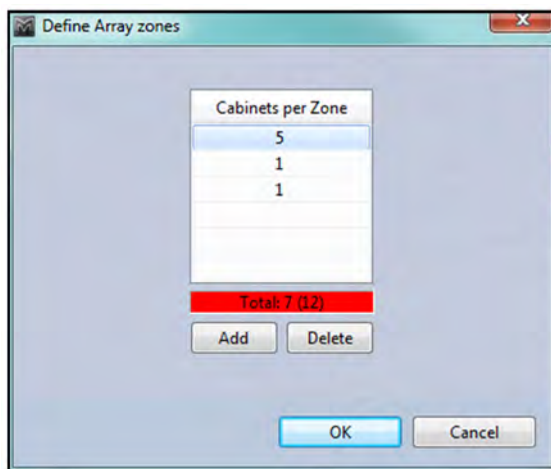

Now type a "6" in the middle zone, we have restored the total to 12 so the total is shown green once again; -

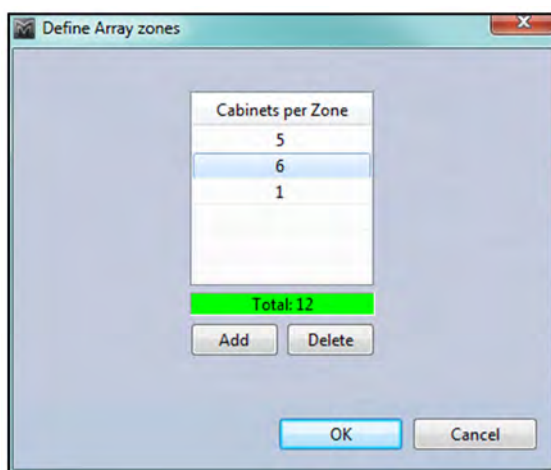

If we need to reduce zones at any time they can be deleted by clicking the delete button. Note that this will reduce the quantity of zones by one but will also reset the numbers in each zone. All zones will have a single cabinet up to the top zone which will have the balance of cabinets required to equal the total in the array. We have finished defining zones so can click OK. You will be warned that any ganging already implemented will be removed which is why it is sensible to create zones prior to any other processing. Processing zones will be covered in later chapters.

### Synchronize

When connecting or reconnecting to any system the cabinets will be synchronised, these is also the facility to re-synchronise at any stage using the right-click menu.

### Delete

Any array or Merlin can also be deleted from the right-click menu. This can also be achieved by selecting the item or items and pressing the 'Delete' Key.

### MLA/MLD & Compact Arrays

MLA/MLD and MLA Compact arrays are almost identical when controlled and monitored via Vu-Net with the only significant difference being that MLA Compact has five cells to MLA and MLD's six. This chapter will predominantly refer to arrays comprising MLA with MLD where the same functionality is available for MLA Compact. All differences between the two will be explained

Double clicking on an MLA/MLD or Compact array or right clicking and selecting 'Open' will open a new window as an additional tab as shown; -



MLA compact arrays will appear almost identically, just under the MLA logo the name is "MLAC" and of course there are only five cells visible in the array thumbnail



This page is the Array Overview; each array also has a tab for Zone PEQ and Ganging. First we will look at the metering and gain faders. Here is a 12 box array that has been divided into three zones, the top eight cabinets, next three and an MLD. The Master and Zone Section looks like this; -

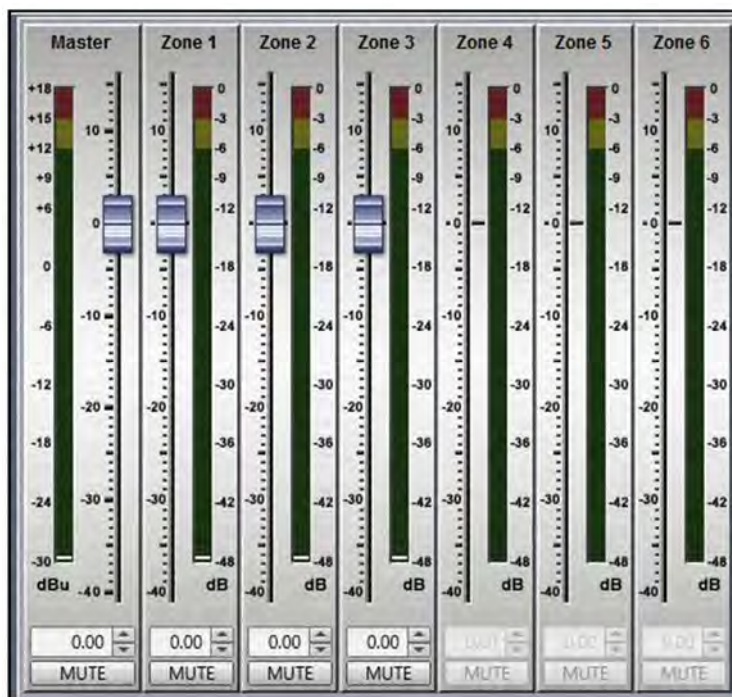

The Master Gain allows up to +15dB of gain or 40dB attenuation of the input level to the entire array, the meter shows the absolute level to the input stage of the cabinets, it is pre-fader so if the level is clipping it is an indication that you need to attenuate the signal upstream of the array, at the mixing console for example. The Master level as with the zone faders can be adjusted in four ways, either dragging and dropping the fader knob to the required level, clicking just above or below the fader knob which will increment or decrease the gain in steps specified in Preferences, clicking on the up/down arrows by the value window or by typing a specific gain into the box at the bottom of the fader. A value between 15 and -40 can be entered, is a value higher than 15 is typed, it will default to 15dB, if a value lower than -40 is typed it will default to -40.

Note that the available gain and attenuation is combined for both the Master and Zone controls, for example if the Master is boosted by 15dB you will not be able to boost any Zones. If the Master is boosted by say 5dB you will have up to 10dB of boost available for the zones. If you attenuate the Master by say -30dB you will only have -10dB of attenuation for the zones and so on.

At the bottom of the Master fader is a Mute button which will mute the entire array. The button and all zone mutes will turn red when activated.

Next are the Zone faders which allow gain trim and mute for each of the zones that have been configured, in the example above there are three. The maximum number is six. Gain may be adjusted exactly as described for the Master fader, dragging the fader knob or typing a value. All zones may be adjusted completely independently. The zones also have a Mute button which will instantly mute a zone. A further click will un-mute the zone.

All zone mute buttons will also turn red to show they are all muted; -



The Mute buttons can be freely changed whilst in normal mode, during set-up for example but when in Show Mode you will be prompted to confirm a mute function to avoid accidentally muting something while a show is in progress. See the Show Mode chapter for more details.

The zone metering is post PEQ, each zone can be equalised independently so the metering will show the effect this has had in addition to the effect that any gain trim has contributed. The zone meters differ from the Master in that they display headroom rather than absolute level. 0dB at the top of the scale indicates clipping the signal level reached will show how much headroom is available before clip.

The entire array is shown as a thumbnail diagram with each cell shown on every enclosure, on the left is an MLA/MLD array, on the right is MLA Compact, both have been zoned in the same way; -

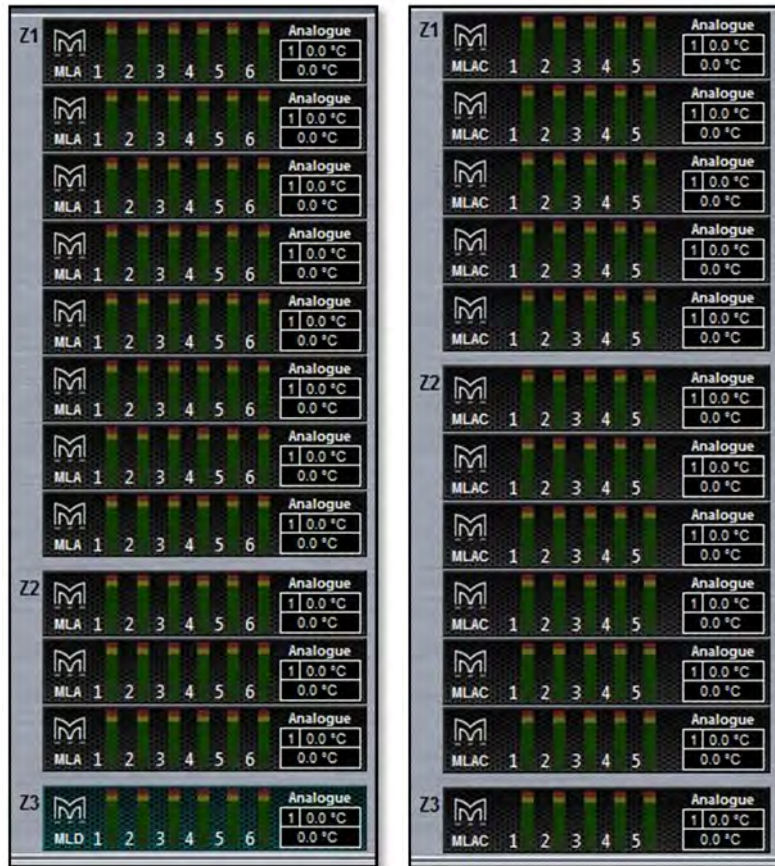

The enclosures are grouped in their zones which are labelled on the left. The type of cabinet is shown on the left under the Martin Audio logo, the MLD is also a slightly different greenish colour. The cells in each enclosure are labelled next to their meters. The metering is post PEQ and pre amplifier and indicates level prior to limit. The yellow OdB segment indicates that the limit threshold has been met, the Red LEDs illuminating show progressive amounts of gain reduction in each limiter.

In the right corner of each element you will see the temperature readout-

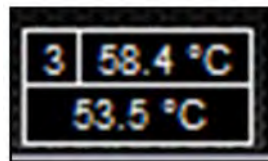

This displays two readings simultaneously, the top reading is the amplifier module that is showing the highest temperature, the number on the left shows which module, in the example above it is number three which is the final two HF cells. The bottom reading is the temperature of the DSP section.

Just above the temperature read-out is a display showing the input setting for each individual cabinet. Here we can see a cabinet set to AES Digital and one set to Analogue; -



This will display the last input setting used with each cabinet so you can see at a glance if you have a miss-match of input modes. When uploading EQ optimisations together with a house PEQ file all inputs are reset to analogue. Alternatively you can change the input mode manually and all cabinets will match, if for example you are running the system with an analogue feed and have one cabinet showing AES, select AES from the input selection (see below) then select analogue to change all cabinets back to analogue inputs. This indication is particularly useful if you have had to change a cabinet or amplifier module after loading optimisations, whilst you will need to reload the optimisation at some point, it is reassuring to be able to rapidly check the input mode if you hear any particularly strange sounds; a mix of analogue and AES inputs can sound extremely unpleasant.

Just below the zone level and metering is LED control if you need to identify a cabinet or cabinets again once you have completed Device Discovery; -



Pressing the 'play' triangle will start the LED running sequence from top cabinet to bottom. The play button then changes to a pause and the 'Next' and 'Previous' buttons are greyed out; -



Clicking the pause button will freeze the LED badge, the 'previous' and 'next' buttons can then be used to scroll the illuminated LED badge between the cabinets. Clicking the square 'Stop' button will extinguish the LEDs.

Below the LED buttons you will find the Delay section which will add a delay to every cabinet. The delay displayed will be that which was already residing in the array DSP when the devices were discovered and synchronised; -

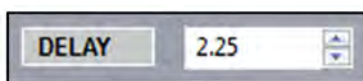

The delay can be entered in two ways, either by scrolling up and down using the up/down button on the right of the value box. The increments are determined by the options in the Preferences menu, either 1.0, 0.5, 0.25, 0.2 or 0.1 milliseconds. Values can also be directly typed into the box. The maximum value is 1,000.00ms (1 second).

Next to the delay is displayed the currently active snapshot; -

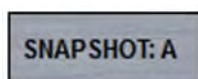

In this case the factory default snapshot A. This display will automatically update when a new snapshot is loaded.

The final section on the System overview is the Input selection; -

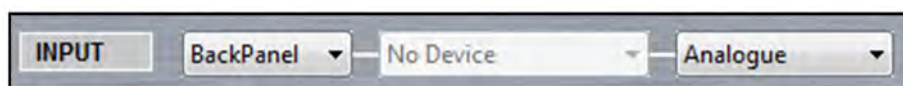

This is divided into three sections, the first shows that the source is from the rear panel XLR input. The second panel will display 'No Device' and will be greyed out, the third panel will allow selection of either Analogue (the default selection) or AES3 Digital;



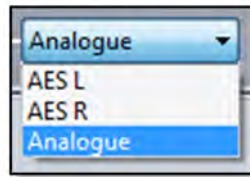

As AES feeds two interleaved digital channels you have the option to select either AES L or AES R. The initial display will match what the array was set to when the system synchronised until you use the Preset Loader and load one of the default PEQ's which will set the input to Analogue. See the chapter of Preset Loading for more detail.

### Array Cell Check

Double clicking on the array diagram brings up a new diagnostics screen which enables testing of individual cells, an extremely useful tool for checking an array over either just before it is flown or back in the shop when a system is checked over. Note that this function is not available when in Show Mode; -



This is how the window appears, the array diagram is still visible on the right but it is now also shown on the left with each cell shown but with a representation of its physical location in the cabinet; -



Each cell can be muted from this section, this can be done by individual cells or the entire cabinet depending on the selection mode selected; -

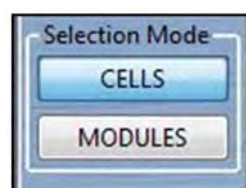

In 'MODULES' mode clicking on any cell will mute or unmute all calls in the cabinet. In 'CELLS' mode you can mute and unmute individual cells by clicking on them; -

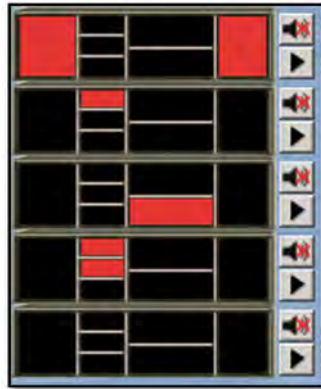

Or an entire cabinet can be muted by clicking on the button to the right of each enclosure regardless of which mode you have selected; -



This is how an entire muted enclosure is shown; -

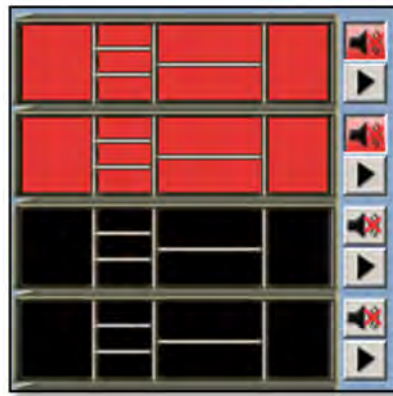

Pressing the Mute Array button; -



Will mute every cell in the array; -

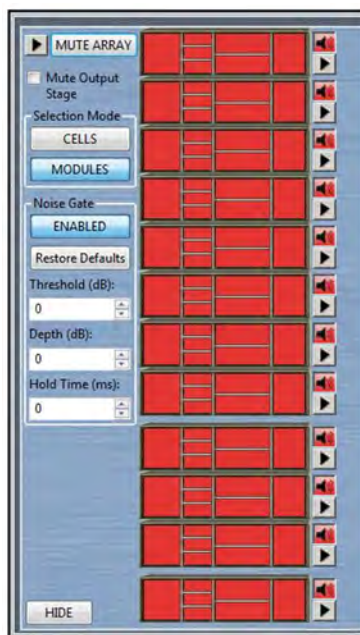

Next to the Mute button is a play arrow; -



This will cycle through either each cell or each module (all six cells) selected using the Selection Mode buttons; -

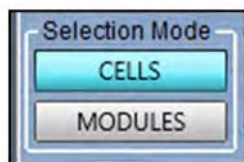

IT will un-mute whoever is selected sequentially so that any audio such as pink noise can be heard through just that section of the array. If the entire array is un-muted when the play button is clicked it will mute the array before starting its sequence.

Below the play button is a check box labelled "LED's ON" which will illuminate each cabinet's front grille badge LED while the cells or entire module on that particular cabinet are un-muted to make it visibly obvious which cabinet you are hearing- something not always particularly easy if an array is 50m or more away from you.

There is an additional play arrow for each individual enclosure should you just wish to test a single cabinet.

It is good practice if you intend to use this test, to recall the default snapshot 'A' first. Without doing this all cells will have the last parameters used still loaded so the sound from each cell when heard individually will vary enormously making it difficult to judge if they are operating correctly.

When you have checked all cells, click on the "play" arrow a second time to stop the mute cycle. This is a very quick and easy test for the system; it can be completed in the shop or on an array that has just been rigged prior to flying the system into place. The big advantage is that there is no need to wait until front of house has been set up or any other part of the system, each array can be tested individually the only additional equipment that is required is a simple signal generator which can even be an app on a smart phone.

When the system has been tested and the signal source disconnected or switched off the system can be un-muted by a further click on the MUTE ARRAY button.

In addition to muting cells, you can also completely disable a cabinet by switching off the amplifier. This is designed for emergency situations if for example an amplifier module has a fault and is generating unwanted noise. If you have tried the mute function and the noise persists it is being generated by the amplifier not anything upstream in the audio path such as the DSP. In that instance the only option is to switch off the amplifier. The mains distribution system has a breaker on each pair of cabinets so if that were to be used to isolate a cabinet you would also unnecessarily switch off its neighbour so the mute output stage function allows independent isolation of a single cabinet without disrupting any other functions. The big advantage of this compared to physically powering off the entire cabinet is that the input and network sections are still powered as normal so no other functions are disturbed, the U-Net array and network will still appear functioning as normal just with the indication that the cabinet amplifiers are off. To use the function first click in the Mute Output Stage box in the top left of the window; -

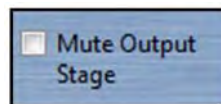

Now click on either the thumbnail or the Mute all channels button of any cabinets which need to be isolated. All cells will appear muted and on the array view you will see AMP OFF appear above the temperature table; -



Note that the Mute Output stage box must remain checked; if it is unchecked the cabinets will revert to the standard mute function and the AMPS OFF flags will disappear.

Also on the test page is the array noise gate control; -

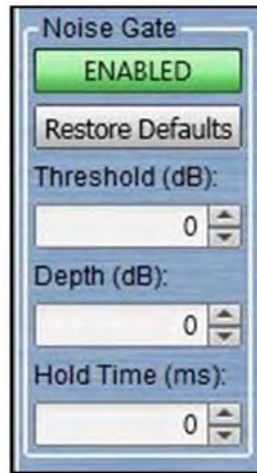

Each amplifier module has an internal noise gate set to keep the amplifier and DSP noise floor as inaudible as possible. By default it is enabled but it is possible that with very low levels of program material the gate operation may be audible and so the gate can be defeated by pressing the ENABLED button. The button will then display 'DISABLED'; -

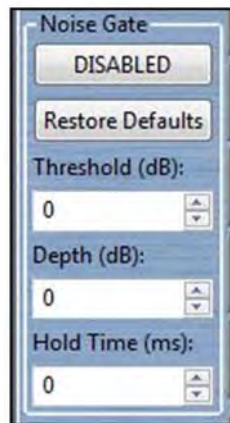

The threshold, depth and hold time have been carefully calculated to give the best balance between making the operation as inaudible as possible and maintaining a silent system but the parameters may be modified by either directly typing a value or by scrolling up or down using the arrows to the side of the value windows. The Threshold can be any value from +20 to -120dB, the depth from 0 to 120dB and the Hold time can range from 0 to 5,000 milliseconds. Default values are threshold of -84, Depth 10 and Hold time of 5000 for MLA and MLD and -67, 10 and 5000 for MLA Compact. These can be restored at any time by clicking the Restore Defaults button.

To return to the main window click on the HIDE button in the bottom left; -

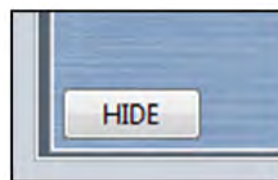

If you have any muted output channels (muted not disabled), you will see the following window; -

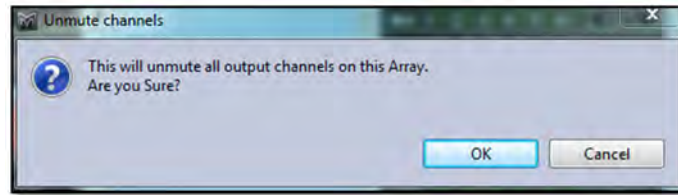

This ensures that you do not suddenly unmute all output channels while you have a test signal applied; pink noise at full volume through an entire array is not something you want to suddenly subject a venue to. If you click OK you will return to the main window and all output channels will be un-muted. If you have disabled cabinets they will show AMPS OFF in the array thumbnails on the right hand side; -



## PEQ Tab

All types of array have a PEQ tab which offers multiple bands of equalisation plus a high pass filter that can be used as a means of tailoring the system sound to suit any preferences of the sound engineer or to deal with any peculiarities of the venue acoustics. It is important to note that this is completely independent to the Optimisation parameters which include parametric, FIR and all pass filtering. These parameters which are created in your Display 2.1 project are uploaded to a completely separate section within the cabinet DSP. They cannot be accessed manually. The PEQ section can be compared to the "grab" EQ in a conventional system which is commonly a third octave graphic equaliser at front of house and is used for subtle adjustment once a system has been configured in the system processors. This is the EQ window which is common to MLA, MLD and MLA Compact;



The window has three sections, the buttons along the top, the graphic display window and the controls on the right of the window. First we will look at the buttons along the top.

First there are ten parametric EQ buttons plus the high pass filter; -



As you can see there are a number of colour variations for these buttons. Unused bands are pale blue until they are selected for editing by clicking on them in which case the colour goes to a brighter blue and the image shows the button depressed. Unused is defined as the gain left at 0dB. A red button indicates that the band has been bypassed, irrespective of whether any gain change has been made. Bypassed bands will change to a pale red when selected. Green buttons indicate a band that has either cut or boost applied, these will go a pale green when selected. Note that the high pass filter is always active so will always appear green.

Next there are the zone buttons; -



In this example the array has three zones with zone 1 selected. As well as individual gain as already discussed, zones each have completely independent PEQ to allow precise adjustment, most commonly used with the MLD which often requires a different equalisation to the rest of the array. Clicking on the zone number brings up the PEQ page for that zone. If the array has not been divided into zones there will just be one button with a number 1, essentially the entire array is a single zone.

The graphic view of the equalisation is a relatively standard frequency response graph; -

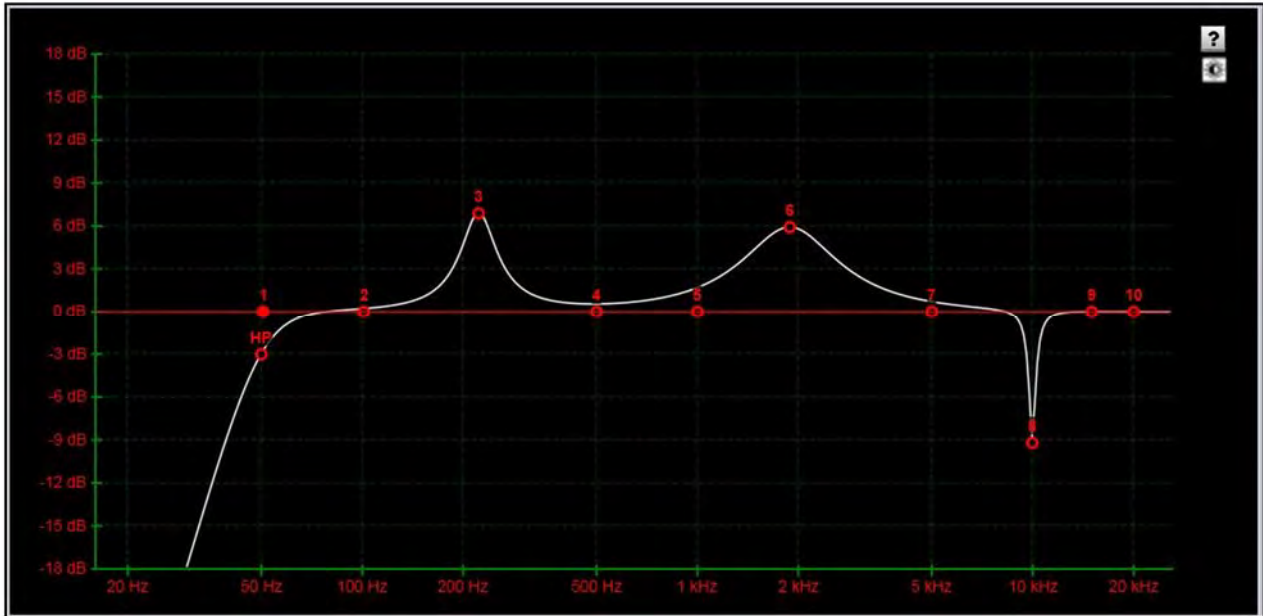

The horizontal axis is frequency in Hertz from 20Hz to 20KHz, the vertical axis is gain from -18dB up to +18dB. Colour coding is also used on the graph to represent the various modes.

First there are two traces, one red, and the other white. The red trace is the response of the band that is currently selected; the white trace is the overall response of the entire PEQ.

Each small red circle represents the position of each of the ten bands plus the high pass. For all of the EQ bands the position on the horizontal represents the EQ centre frequency, the vertical position is the cut or boost applied. A solid red circle is the currently selected band, any greyed-out band indicates that an EQ has been bypassed. The circle labelled "HP" identifies the cut-off frequency of the highpass filter.

In the right corner is this icon; -



This is used to cycle between standard and daylight modes. In daylight mode the display changes to look like this; -



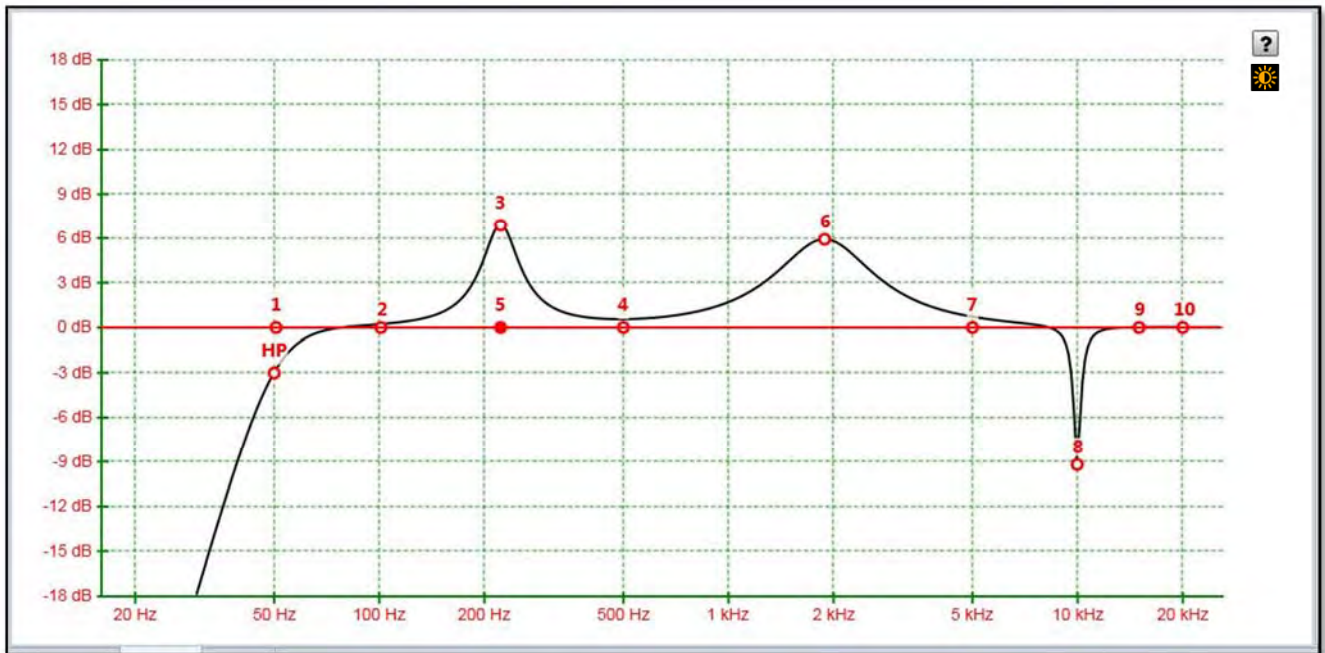

This is intended for use outdoors setting up a festival system where the normal display is difficult to view in bright sunlight. A further click on the icon will return to the default view.

In common with most PC controlled equalisation systems it is possible to make adjustments by dragging and dropping the filter curves. Left-click on any of the band rectangles and holding down the left mouse button, drag the icon horizontally to change the centre frequency or vertically to change the gain. Either Right-click and drag up and down or press Ctrl and drag up and down to adjust the filter Q factor. You can also use the left and right keyboard buttons to adjust the selected band frequency, up/down buttons to adjust gain and Page Up and Page down buttons which will adjust the Q factor. The graph will adjust and the audio adjustment will be made in real time.

If at any stage you need a reminder of how to control the PEQ, right click on the question mark icon at the top of the graph; -



This will bring up the following window; -

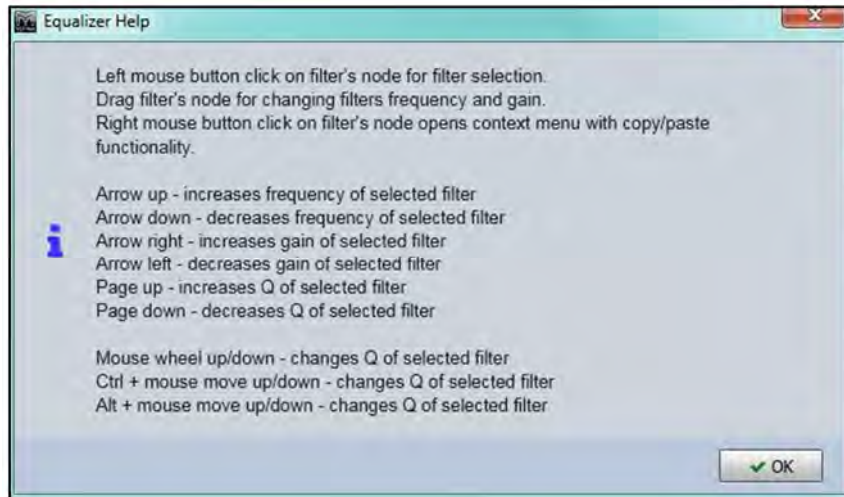

There are also other functions available by right-clicking elsewhere in the graph window whilst the cursor is over one of the filters. This is the window that appears; -



First is a copy all function which will copy Gain, Frequency and Q, of the selected band. You can also copy Frequency, Gain or Q individually, you can then select a different band on the same or another graph (on a different zone or even different array) and paste whichever parameters have been copied. The paste option will paste whoever parameter or parameters have been copied onto the new filter that you have selected

The final section on the right of the window is the Properties panel; -

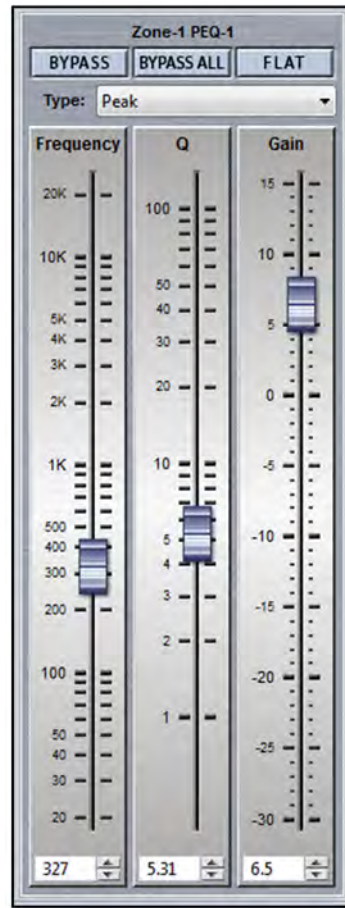

This shows all properties of the selected band. At the top you will see some text indicating which zone and which band the properties apply to. Below this are three buttons; -

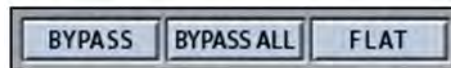

BYPASS bypasses the individual band you have selected turning the BYPASS button and the filter button red. BYPASS ALL bypasses every band. FLAT will instantly change the gain to 0dB.

Next is a Filter type. Click on this and the drop down shows the options for each filter band; -

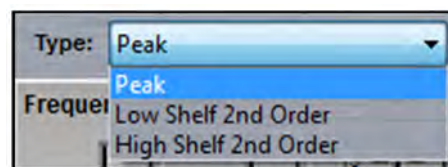

The default is 'Peak', a standard parametric EQ; the other options are 2<sup>nd</sup> order Low Shelf and 2<sup>nd</sup> order High Shelf.

Below are the three principal faders for adjusting the filter parameters; -

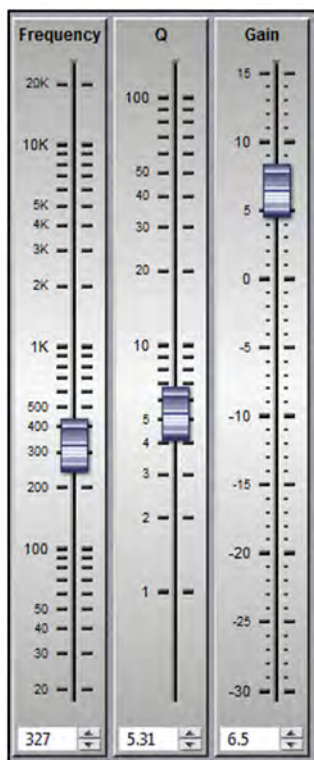

Parameters can be changed on the properties panel in three ways. The faders can be drag and dropped to a new value, the value can be scrolled up or down using the up/down buttons to the right of the value windows, and finally values can be directly typed into the value windows. The response graph will adjust according to the new values and vice versa, adjustments in the graph window will be reflected in the fader positions and values in the properties panel.

The High pass filter only has a single fader for the corner frequency. This may be adjusted in exactly the same way as the faders for the PEQ's. The 'Type' drop down offers three types of filter and slopes from 6dB up to 48dB per octave; -



To summarise, there are FIVE ways to adjust filter parameters; -

1. Click and drag on the graph
2. Use the arrow and page up & down buttons
3. Click and drag the properties faders
4. Use the up/down value buttons
5. Directly type values into the value boxes.

Whilst this might seem over-versatility, it is intended to offer several options to suit the way that the system is being operated. If adjustments are being made with a tablet PC in tablet mode with a stylus whilst walking around a venue, certain options may be easier to use than if you were sitting at a desk with a mouse plugged in to the PC.

### Array & Zone Ganging

MLA Systems have a highly versatile set of ganging options to help make system set-up consistent across arrays or zones. This is the ganging page for a project consisting of two main MLA Arrays each of 12 enclosures and divided into three zones, plus two side hangs each of 7 MLA plus 1 MLD. Ganging is accessed from the Toolbar button; -



All devices in a system will be shown, in this project we have a Master and Slave Merlin, two main arrays of MLA, two side hangs of MLA Compact and two DD12 fills; -

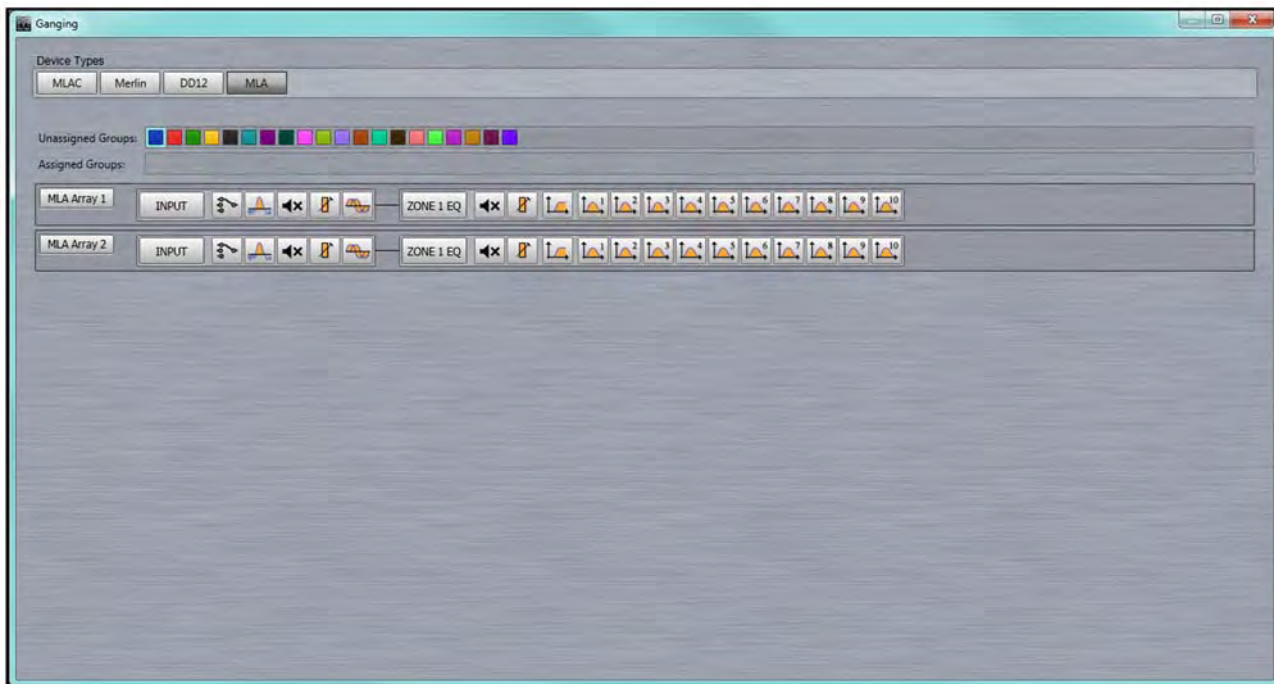

The Device Type strip across the top is used to select the device type you need to gang.

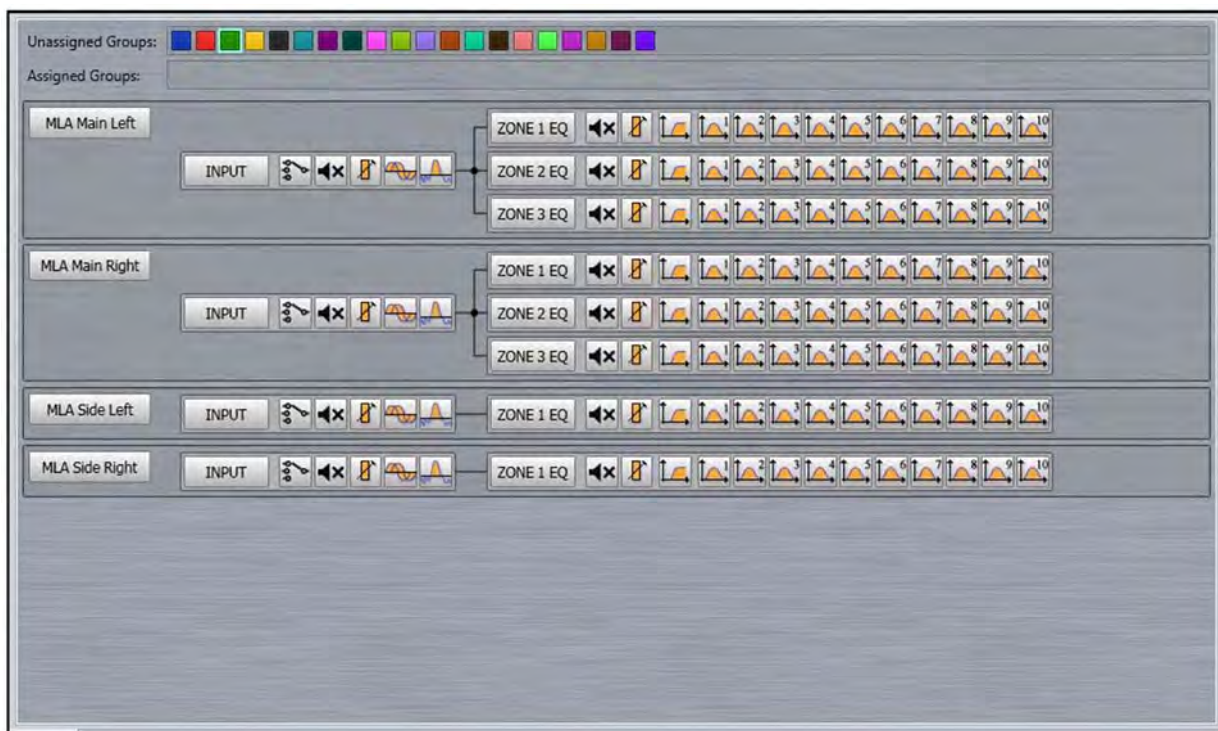

The icons represent the functions in each array the input functions appear as so; -



Left to right these are input source, Master Mute, Master Gain, Delay and Noise Gate (hovering the cursor over any icon will show a label if you forget what any of the icons represent). Note that all gain and delay parameters are offset ganged. If there is already a value entered before ganging is implemented this will be retained and subsequent changes to a value to any ganged gain or delay will increase or decrease all values according to any edits you make but will retain the offset between all values.

The EQ appears like this; -

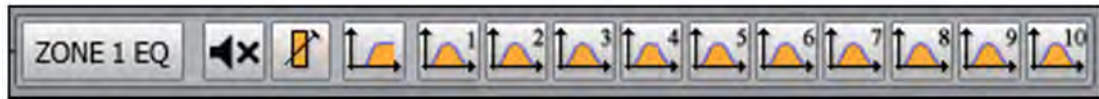

The functions are Zone Mute, Zone Gain, Highpass filter and the 10 bands of available parametric EQ.

It is possible to Gang an entire array or any individual function using the ganging groups at the top of the window.



### Array ganging

The quickest way to gang a system and arguably the most common method is to click on the Label for the array. If we use the side hangs as an example as they are a single zone, click first the "MLA Side Left" and all functions turn the colour of the first available unused zone Group which is blue. Now click on "MLA Side Right" and its controls also turn blue. Alternatively, however you mouse over MLA Side Left for a few seconds until two arrows appear above the button. Move to the single arrow and the message "Apply to below items within the array/device". This is the same functions as clicking on the button. Move over to the double arrow and the text "Apply to ALL items below" appears.

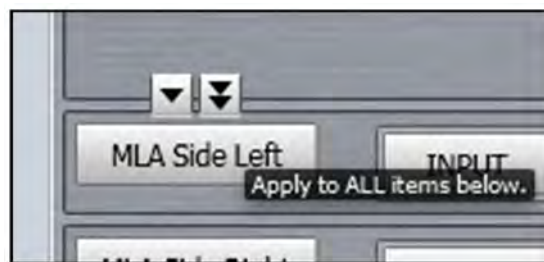

Click on the double arrow and both arrays will be ganged. This option will gang all of the same function on arrays below the button; -

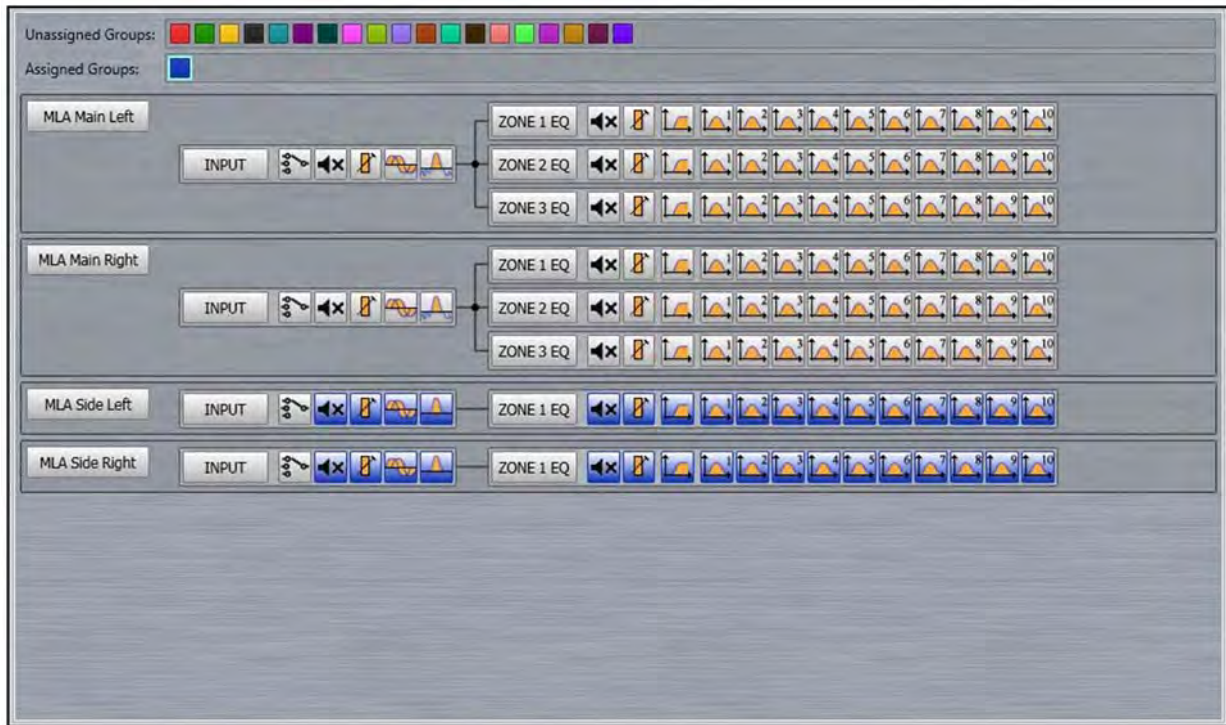

Note that input source selection is not automatically ganged either by using the Array name or the Input group, these must always be selected individually to join a gang.

If we do the same with the main Left and right arrays they will also be ganged but as the arrays have been zoned into three, each zone is ganged individually zone groups being assigned in order of their availability; -



You can see that zone 1 is red, zone 2 green and zone 3 yellow. Any EQ changes made on any zone will be duplicated in the zone on the other array.



It is also possible to zone just the array input functions, just the array EQ or individual parameters. In this example we just required the side hang EQ to be ganged leaving the input functions available for independent adjustment. First we selected an available Group, in this case pink, then clicked on "Zone 1 EQ" on both Side arrays; -



If we wanted to add the gain and delay to this gang simply click on those icons either individually or using the double arrow; -



Perhaps a more practical example is to gang the entire array and just de-select any parameters that we do not wish to gang, here we will gang both Main left and right together, both Side hangs but then click on the mute icon so we can mute and unmute each array independently of each other; -



To un-gang any individual parameter, input parameter group, EQ group or entire array just click a second time and the ganging is removed.

### MLX & DSX Arrays

MLX and DSX share many similar features to MLA, MLD and MLA Compact and are virtually identical to each other with regards to Vu-Net operation. Double clicking on a six box MLX array brings up this window; -



And DSX looks like this; -



Almost identical with just a minor difference in the position of the Led bargraph in the array diagram and of course the name under the Martin Audio logo.

The input gain and muting is identical to other cabinets and sub arrays can be zoned in exactly the same way giving independent gain and mute on the Overview page; -

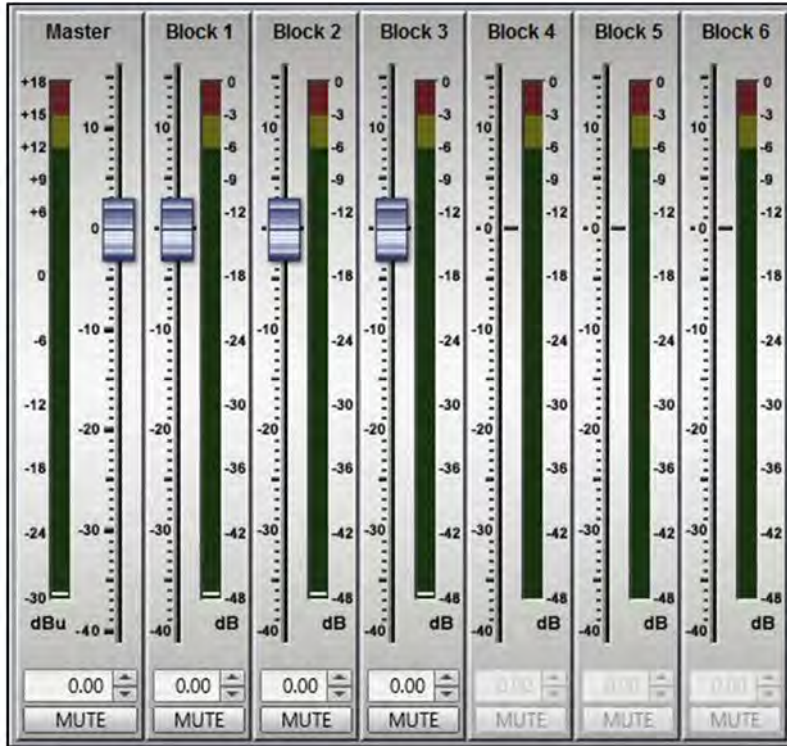

Sub arrays when zoned are referred to as 'blocks' rather than zones.

The array thumbnail is almost identical to the MLA/MLD and MLA Compact just with a single LED level meter to reflect the single cell. The temperature readout will always show '1' and display the temperature of the single amplifier channel on the top line and the DSP on the lower line. Input mode is also displayed above the temperature read-out. If the array has been zoned the zones or "blocks" are numbered from top to bottom; -

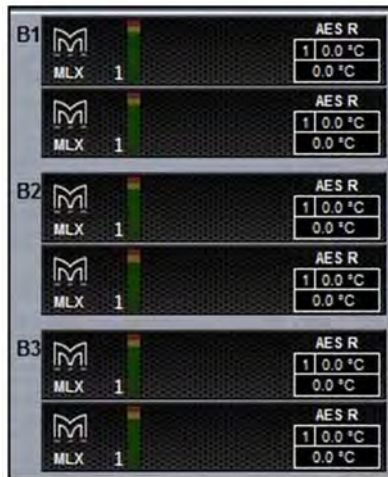

Both subs have exactly the same LED, Array Mute, delay and input routing as for MLA, MLD and MLA Compact; -



There is however the significant difference of there being no snapshot name as subs do not have snapshot capability and there is an additional button "SHOW OUTPUT" which replaces the double click on the other products to bring up additional features; -

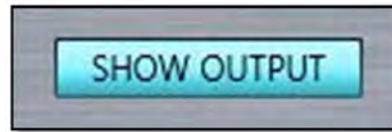

Clicking this button brings up the following window on both MLX and DSX; -



This allows individual control of gain, phase, polarity and mute for each sub in the array. Most often used when creating cardioid arrays with a third of the subs rear facing and requiring independent control of the rear facing subs to the front. The LED button gives you the option to flash the LED of each sub to ensure that you are applying parameters to the correct cabinet. The gain allows independent adjustment of the gain of each sub and is automatically adjusted to match the gain structure of the system determined by the SPL reference set in the Display 2.2 optimisation, see the chapter on Preset loading for more details. If at any stage you wish to reset the parameters, perhaps immediately after device discovery where the subs may still be displaying values from their previous use, you can click on the 'Reset Outputs' button; -

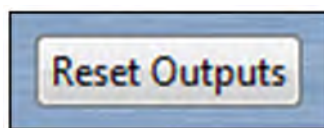

A warning window will appear; -

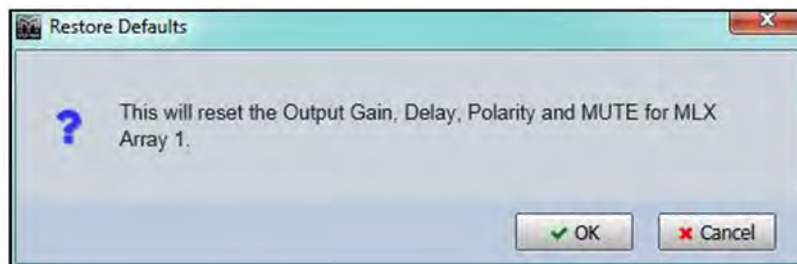

If you click on OK, all gain and delays will be restored to zero, any inverted outputs will be re-inverted and any muted outputs will be un-muted.

Subs also have the facility to turn off any troublesome amplifiers by checking the 'Mute Output Stage' box; -

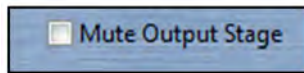

Then clicking the Mute button on any sub you wish to turn off.

As with other cabinets there is a noise gate which has the Threshold and Hold Time available for modification. The Default values can be restored at any time by using the Restore Defaults button; -

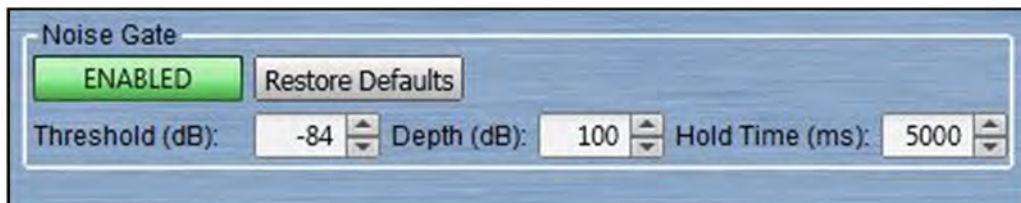

Both MSX and DSX have default values as shown above of a threshold of -84dB, a Depth of 100dB and a hold time of 5000ms.

When you have finished setting output parameters you can close the output window with a further click on the SHOW OUTPUT button. Any amplifiers that have been switched off will have the AMPS OFF indication above the temperature read-out; -

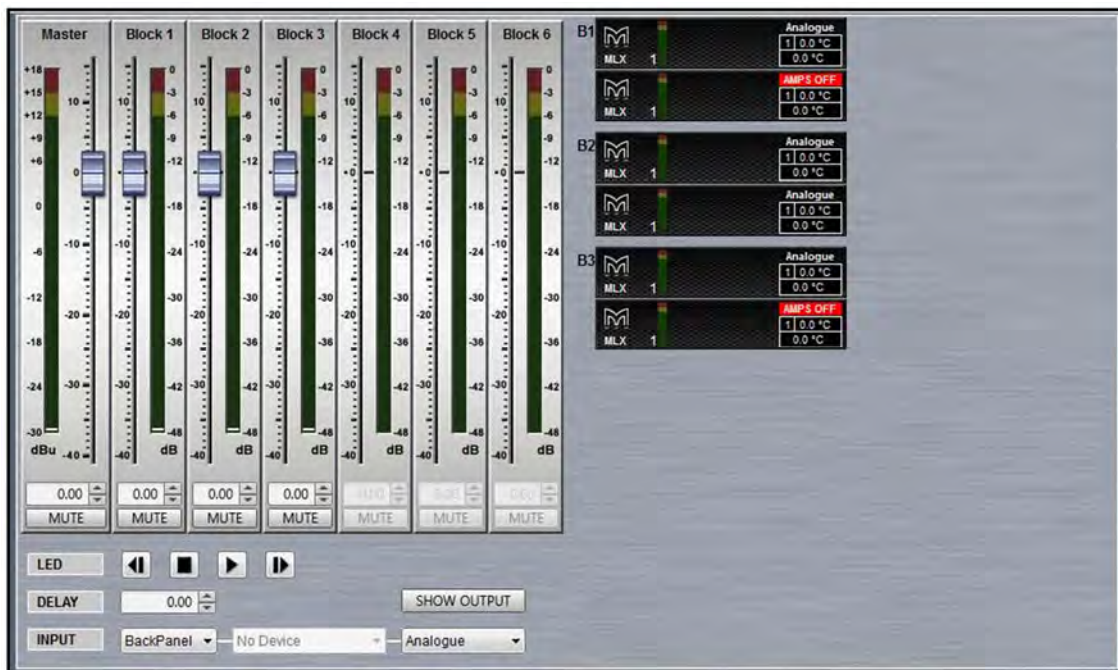

## Block PEQ

Equalisation in the subs is referred to as 'Block PEQ' on the tab. It is almost identical to the EQ page for the MLA, MLD and MLA Compact with a low pass filter replacing the high pass as you might expect; -

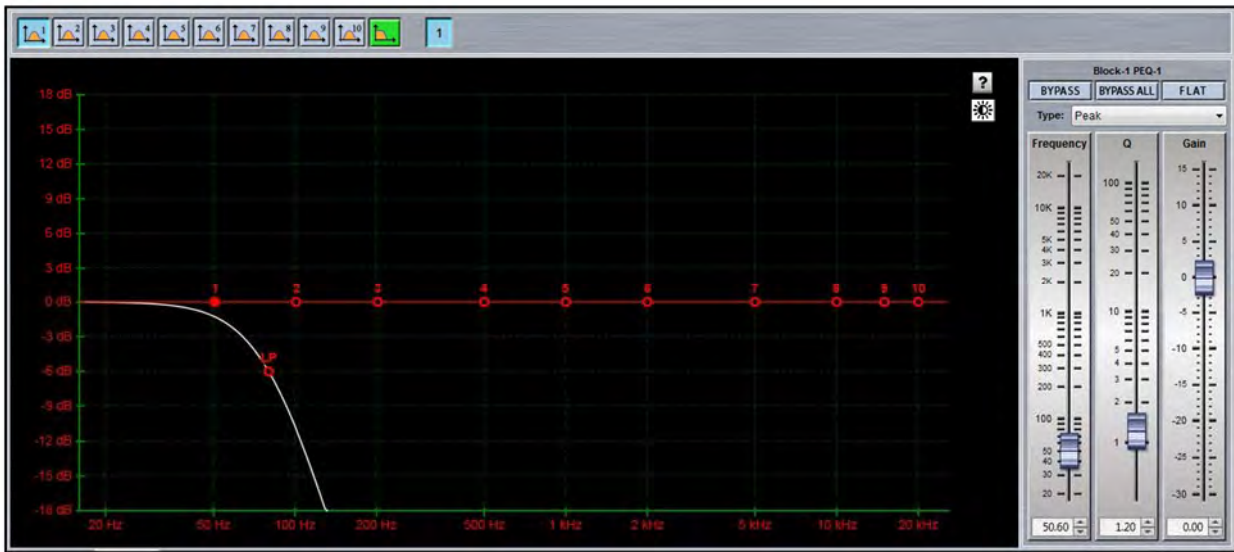

There are also ten PEQ filters at your disposal, each with exactly the same functionality and control. The low pass filter in common with the high-pass in the MLA, MLD and Compact, can be either Bessel, Butterworth or Linkwitz Riley with slopes from 6dB per octave up to 48dB per octave. The frequency can range from 50Hz up to 500Hz; -



### Sub Array/Block Ganging

Sub arrays can be ganged in virtually identical fashion to MLA, MLD and Compact, either by entire array, Input parameters, Zones (blocks), or individual Parameters. To open ganging, click the ganging button on the toolbar; -



This opens the ganging view for MLX or DSX

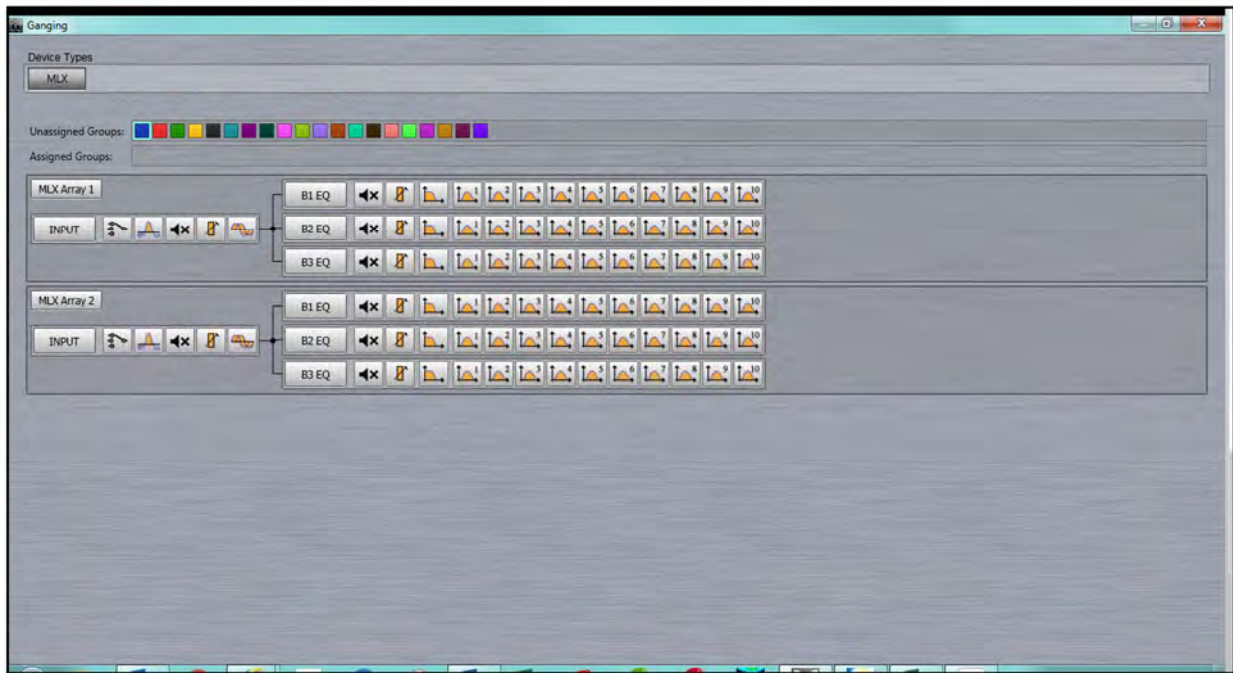

Here we have a stereo pair of sub arrays which have been split into three blocks and each block has been ganged together, Block one with the Blue ganging group, Block 2 with the Red group and Block 3 with the Green Group.



Ganging can be very useful for Cardioid arrays but it is important to remember that individual delays and polarity are NOT ganged; they must be individually modified in the array output page. Note that all gain and delay parameters are offset ganged. If there is already a value entered before ganging is implemented this will be retained and subsequent changes to a value to any ganged gain or delay will increase or decrease all values according to any edits you make but will retain the offset between all values.





### MLA Mini

MLA Mini retains many of the network features of its bigger brothers but with a slightly different approach to the implementation within Vu-Net. Double clicking on an array (regardless of how the system has been deployed), brings up the following Window;

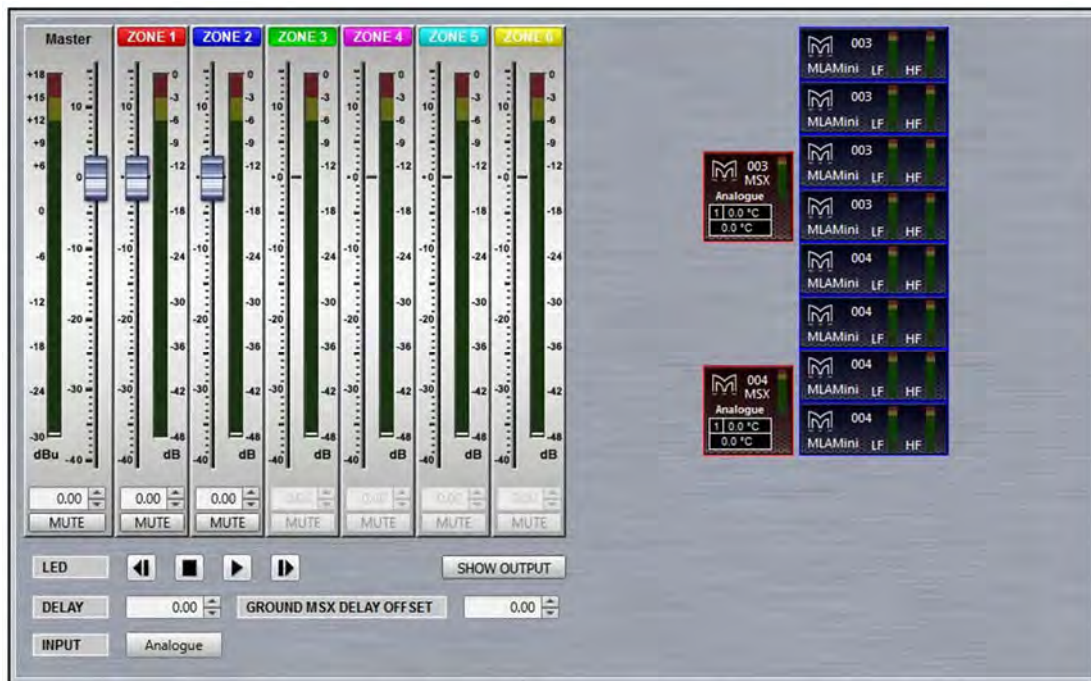

As you can see, the main array window is almost identical to the other MLA System components; there are the usual six zones available each with a gain fader and mute switch. As with other systems, unassigned zones do not have a fader and the gain read-out and mute switch are greyed out. If you attempt to adjust gain or mute an un-assigned zone you will see the following window;

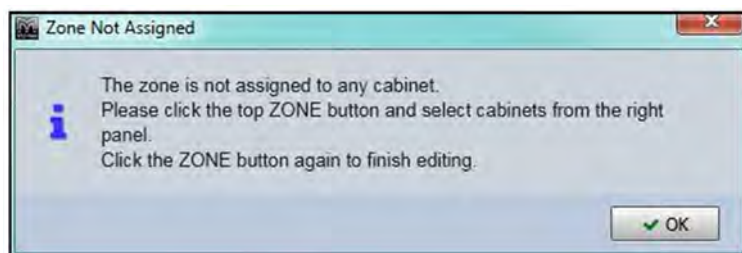

There is the same LED badge option, up to 1,000ms of delay and a similar input select from either the back panel or U-Net (not presently implemented) and back panel input can be either Analogue, AES3 Left or AES3 right with the addition of an AES split mode which routes AESL to the MSX and AESR to the MLA Mini;

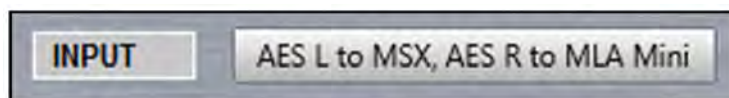

In common with sub arrays there is a SHOW OUTPUT button to access array utility functions rather than double clicking on the array thumbnail.

### MLA Mini Cell check

As long as Show mode is not active, clicking on the SHOW OUTPUT button;

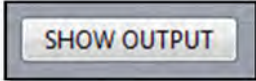

Brings up an array diagram with each cell individually accessible as with MLA and MLA Compact systems. Clicking on the MUTE ARRAY button will mute every cell; -

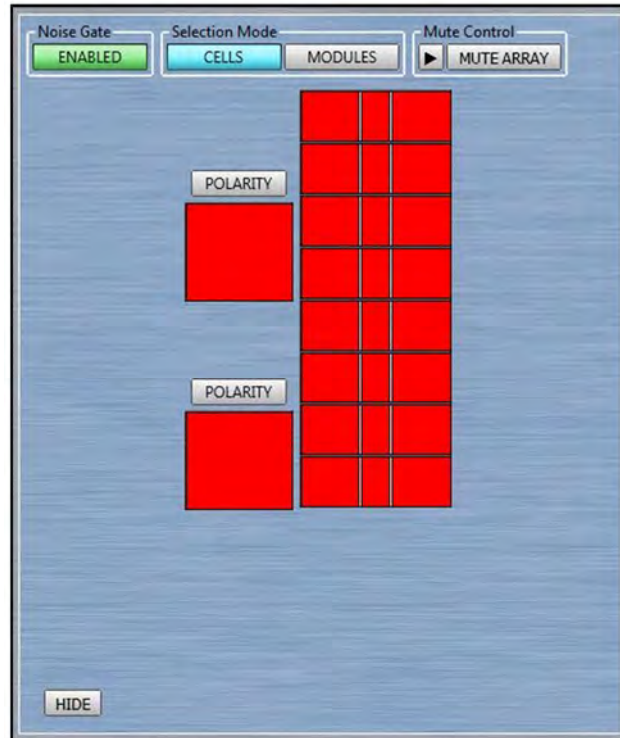

A test signal such as Pink Noise can be applied to the array and each cell can be individually un-muted by clicking on it to test that everything is operating correctly and all components are in the correct position in the array. This can be done by individual cells if the Selection mode is in the 'CELLS' position or by an entire MLX and 4 Mini group if you click on 'MODULES'. This is particularly important as the amplifier modules are all in the MSX sub, it is possible to incorrectly wire from the MSX to the MLA Mini. You can either click on cells manually to unmute them and there is a "play" function to cycle through all cells in the array. Unlike the other systems, unmuting a cell will mute all others which speeds up the testing process as you no longer need to manually mute the last cell you listened to before un-muting the next.

As with the other cabinets, the array noise gate is accessible but in MLA Mini there is only the option to Enable or Disable the gate; -



When you have completed any testing, click on the HIDE button; -



Which will un-mute all cells and return you to the main array window.

### Assigning Zones in MLA Mini

As with MLA, MLD and MLA Compact, there are up to six zones available for the system as the Array Overview shows. How these are defined is however different from the other MLA components. You may have noticed that the right-click function in the System diagram does not allow zone definition for an MLA Mini Array. Instead, zones are defined using the zone faders. If you look at the Array Overview thumbnail, you will notice that the MSX (two in our example) have a red border and the 8 MLA Mini have a blue border; -



By default, MSX are assigned to zone 1 and all MLA Mini to zone 2. Reassigning zones is extremely simple. In our example we will keep the MSX assigned to zone 1, the top four MLAMini to zone 2, the next two to zone 3 and the final two to zone 4. First click on the Zone 1 label; -



You will notice All components that are already part of the zone will turn red; -



Click the Zone 1 label a second time and the two MSX will return to the normal view. Click on the Zone 2 label and you will see all of the MLA Mini turn blue; -



Now click on Zone 3 and there will not be any illuminated cabinets. Next click on boxes five and six, these will turn green; -



This indicates that these cabinets are now part of zone three. Finally click on Zone 4 and then the final two MLA Mini; -

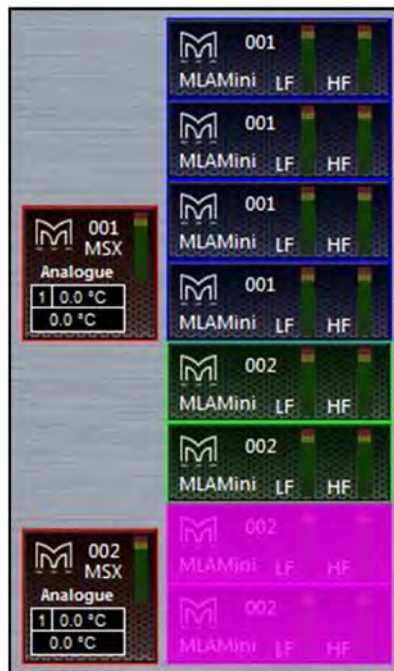

If we click again on zone four the solid block of colour disappears leaving just the coloured outline to show which boxes are members of which zone. The array is now fully zoned as we wanted it; -



### MLA Mini PEQ

The MLA Mini Zone PEQ window appears like this; -



It is a slightly simplified version of the PEQ Tab that is available in all other array components. The six available zones can be selected by using the Zone buttons at the top of the window; -

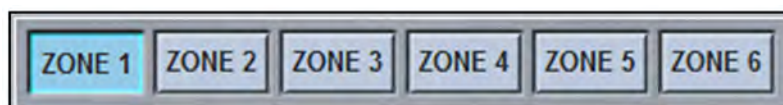

Zone 1 is always the MSX sub so the EQ bands available are slightly different. There is a high pass filter, low pass filter and three bands of PEQ all of which may be adjusted in the same way as the PEQ in all other array types; grabbing the points on the graph,

adjusting the controls in the EQ panel on the right or directly entering the required values in the windows at the bottom of the EQ panel.

Zones 2 to 6 all have a high pass filter and six bands of PEQ; -



## MLA Mini Ganging

Ganging for MLA Mini is handled in an identical way to all other devices. First Select Ganging using the ganging button on the toolbar; -



We see the following view. Note that for this example we have a Vu-Net project consisting of two main left and right arrays each with two MSX and eight MLA Mini, plus two "side" arrays each with a single MSX and four Mini. The larger array has four zones; one for MSX and three for the array, the side arrays have the default two zones; -

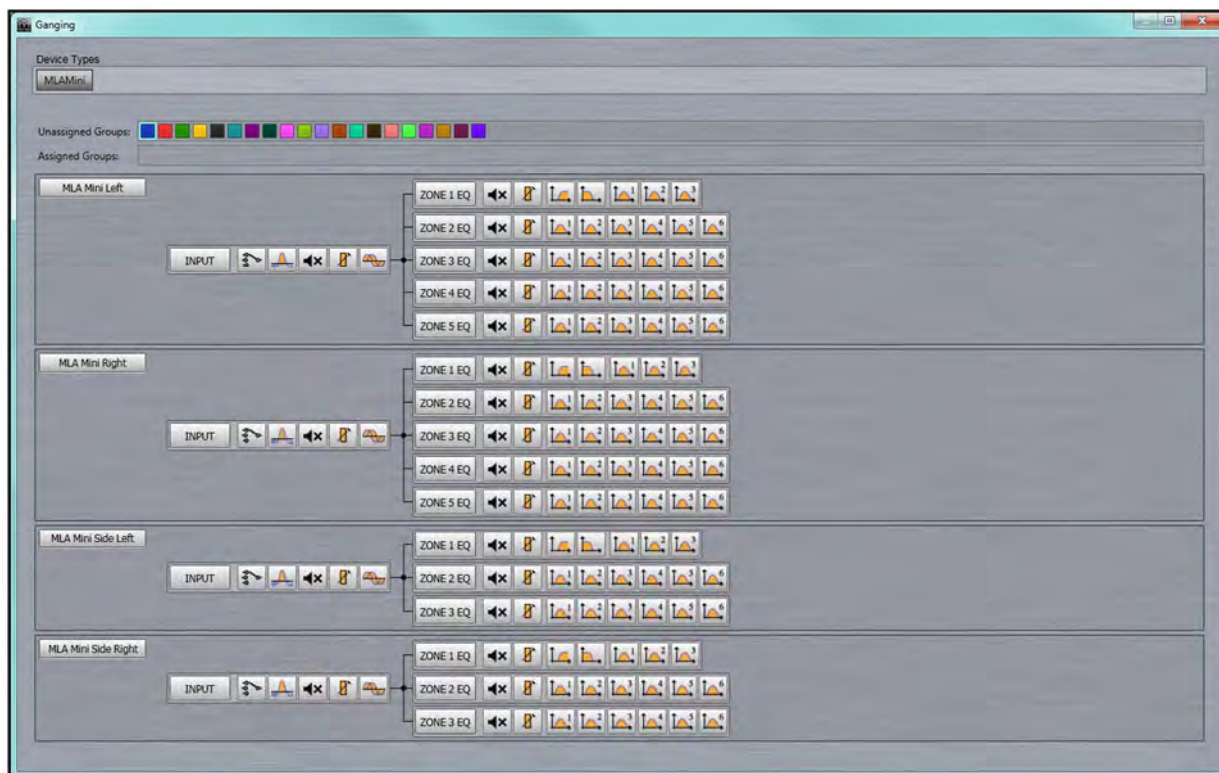

In exactly the same way as other devices you can choose to gang the entire arrays, just the input parameters, the output parameters by zone or individual parameters. Note that all gain and delay parameters are *offset* ganged. If there is already a value entered before ganging is implemented this will be retained and subsequent changes to a value to any ganged gain or delay will increase or decrease all values according to any edits you make but will retain the offset between all values.

There are the same 20 independent groups available for both types of ganging, selected by the coloured Group buttons along the top of the window in the Unassigned Groups section

### Array Ganging

To gang an entire array, click on all arrays you wish to be ganged together. In our example we will gang the main left and right arrays and on a second group the two side arrays. There is no need to select a group they will be assigned automatically with different groups for each zone. You will need to select a different group to zone the side hangs; -





If you wanted all four arrays zoned together you can use the double arrows that appear on any of the buttons when you hover the cursor over them for over a second; -

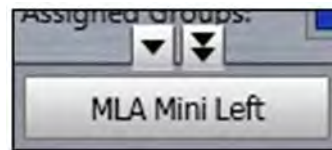

When you gang arrays which have different numbers of zones you will see this message; -

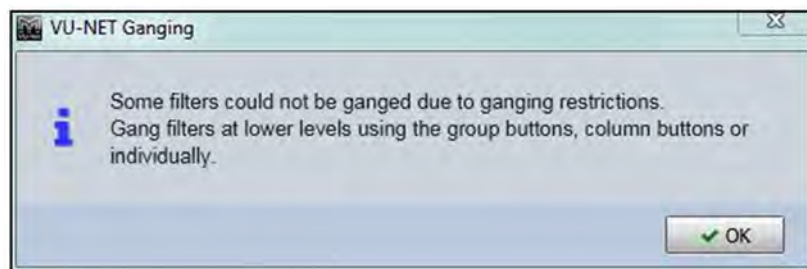

Any of the individual parameters can be excluded from a ganged system simply by clicking on them. A typical example might be to gang everything other than mute so you can ensure that arrays are matched left and right but have the ability to mute them independently, useful during set-up. All parameters other than input source are ganged when using the array buttons so click one any you wish to exclude. Here we have added the input source and removed Mute from the ganging for both main and side arrays; -



Note that the reason for input source not being automatically included in array or input gangs is to cater for systems using an AES3 input where it is likely that the left array will use AESL and the right AESR. It is perfectly reasonable to gang the input source on all arrays if the signal feed is analogue.

**Input Ganging**

You can also choose to gang just the input functions of mute, gain, delay and noise gate by selecting the INPUT button for all arrays that you wish to gang. As with complete array ganging you can use the double arrow or click on input buttons individually



## Zone Ganging

Zones are ganged in exactly the same way by first selecting a group and then clicking on the required zone. Ganging can run across the zones of all arrays or just across some. In this example we have ganged Zone 1 (the MSX sub) on all arrays and all other zones are paired across the main and side arrays. We have removed the ganging on the zone mutes so these can be independently muted and un-muted during set-up



Individual parameter zoning is simply a case of selecting an unassigned group and clicking on individual parameter icons to add them to the gang.

## DD12

DD12's are discovered in exactly the same way as any other device regardless of whether they are connected via a full U-Net network to a Merlin or directly via USB. The Device discovery will show all connected cabinets; -

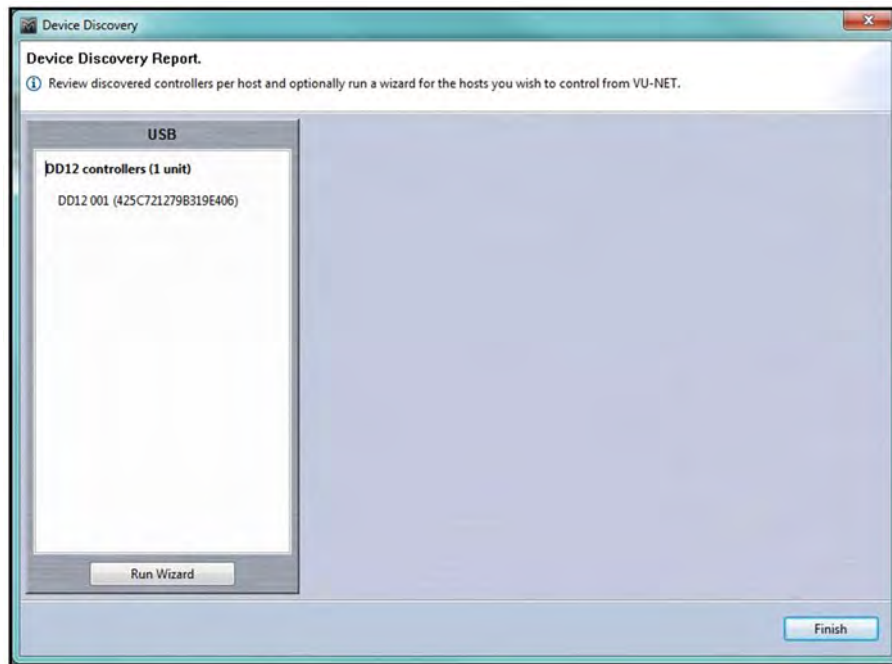

As there are no array-related options with the DD12 the 'Run Wizard' merely synchronises with all connected cabinets so the software reflects the settings in the devices.

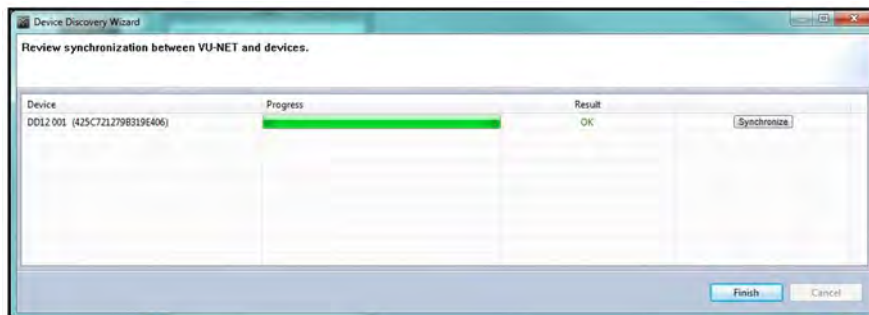

A system connected via USB will appear like this; -

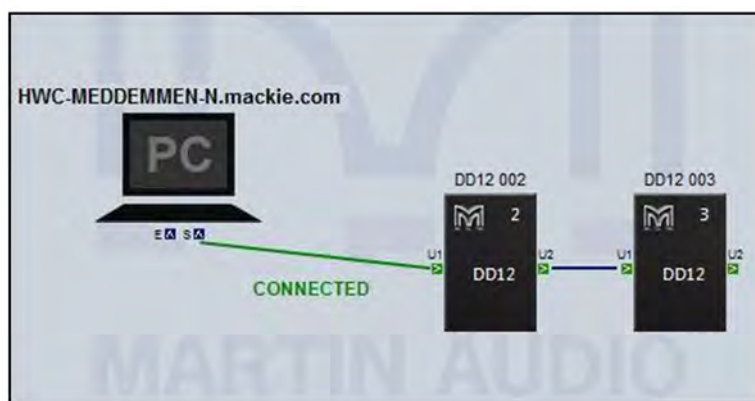

A system connected via Merlin like this; -

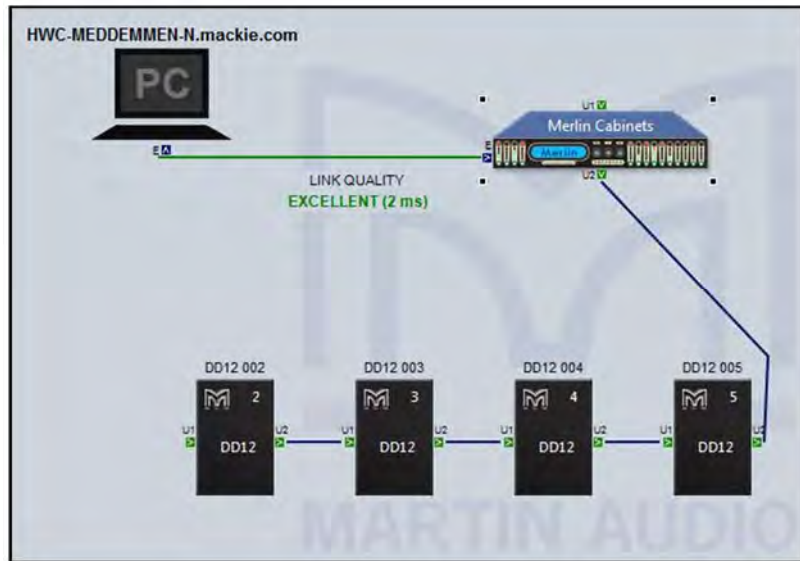

Each DD12 icon in the overview screen features a Martin Audio logo. Double-clicking on this will illuminate the LED on the cabinet front grille to assist in identifying each DD12 which is very useful when multiple units are deployed.

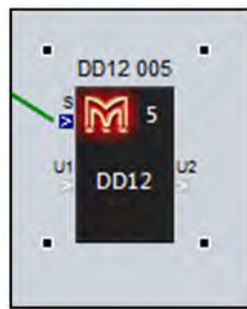

There are a number of functions available by right clicking on a cabinet icon; -

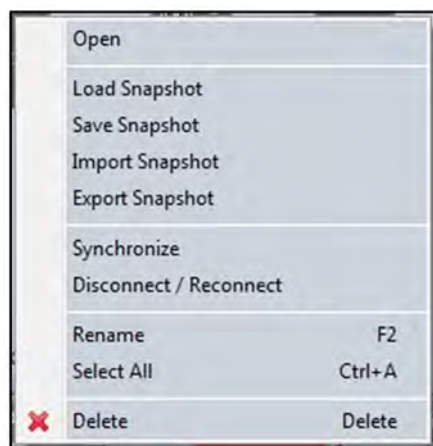

'Open' functions in exactly the same way as double clicking on the cabinet icon and opens the DD12 overview screen to allow detailed control and monitoring

'Load Snapshot' brings up the snapshot window allowing you to select with one of the factory or User snapshots if any have been created; -



Click on the snapshot number to choose the snapshot you need; you will be prompted to confirm; -

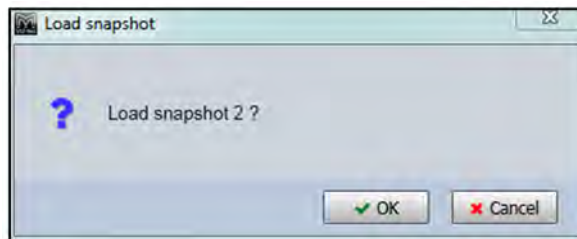

'Save Snapshot' allows you to store a configuration that you have created to one of the User Snapshot locations. There are 12 locations available; -



Click on the Snapshot letter for the location you wish to use and you will be prompted to assign a snapshot name; -

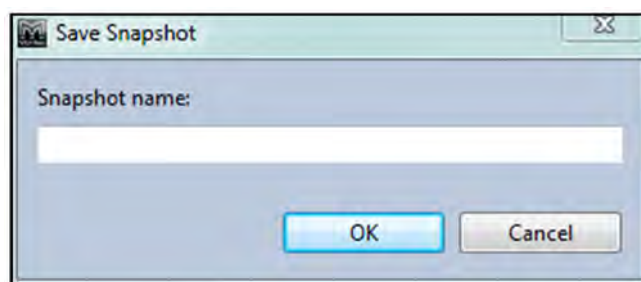

Type a name of up to 30 characters and the snapshot will be saved.

'**Import Snapshot**' allows you to recall a DD12 snapshot that has been exported to a file. Selecting Import brings up this window; -

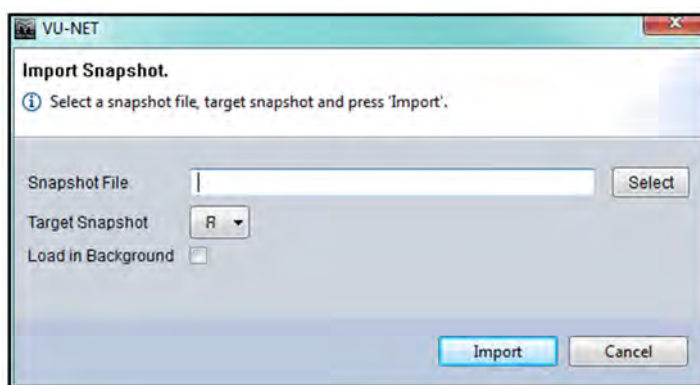

Click 'select' to navigate to the file location where you have stored DD12 Snapshot files. Next click on the target snapshot location within the User Locations, note that the imported file will overwrite any existing snapshot so if you need to retain any of those select a vacant location. Click 'Import' and the file will be imported and that snapshot immediately selected.

'**Load in Background**' allows you to load a file to a snapshot location of your choice and as long as you don't select the active snapshot location the file will be uploaded without disturbing the settings, even if the cabinet is in use passing audio.

'**Export Snapshot**' is how you create the DD12 .sn files which can be imported at future events. The Export window appears like this; -

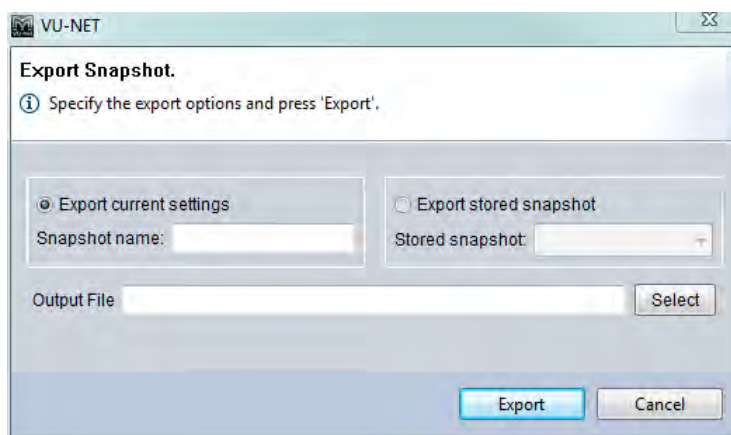

You can elect to export the current settings giving the file an appropriate name, or one of the existing snapshots. Selecting this option will allow you to select one of the stored snapshots from a drop-down list. The drop-down ignores any undefined snapshot locations; -

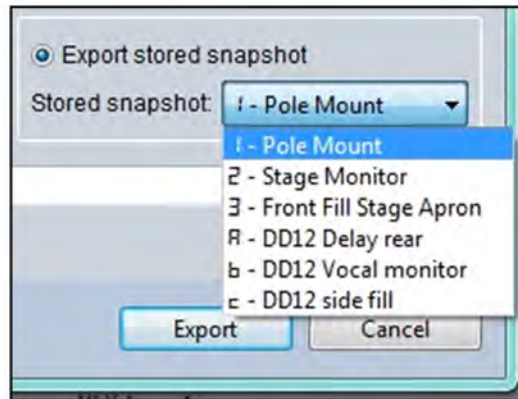

Click Select and navigate to a suitable location on your PC and give the file a suitable name, the file will automatically have a .sn file extension generated. Click 'Export' and the file will be stored.

'**Synchronise**' is a manual synchronise that duplicates the automatic synchronise that occurs when a DD12 is discovered to ensure that what is displayed in Vu-Net matches exactly the parameters stored within the cabinet DSP.

'**Disconnect/Reconnect**' allows you to disconnect and individual cabinet which will turn red once disconnected; -



Selecting the same function will reconnect the cabinet and it will revert to the standard appearance.

'**Rename**' as with any other device allows the cabinet to be given a name of up to 50 characters; -

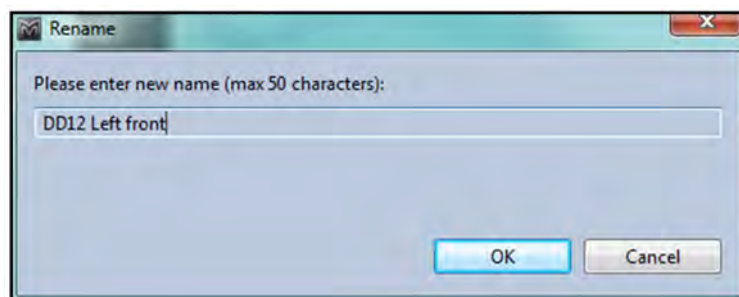

'**Select All**' selects all devices in the system Diagram, the keyboard shortcut for this is Ctrl + A.

'**Load Preset**' allows you to load one of the already stored Presets. The Preset window appears; -

Click on the required preset and you will see a Window asking you to confirm your selection; -



'Delete' removes the selected DD12. You will be prompted with the following Window to confirm the delete; -



If you selected Delete accidentally or have changed your mind, click 'Cancel', otherwise click 'OK' and the DD12 will be removed from the project.

### Overview

Either double clicking or right clicking and selecting Open will bring up the overview option for the DD12 which shows all DD12s in the project; -

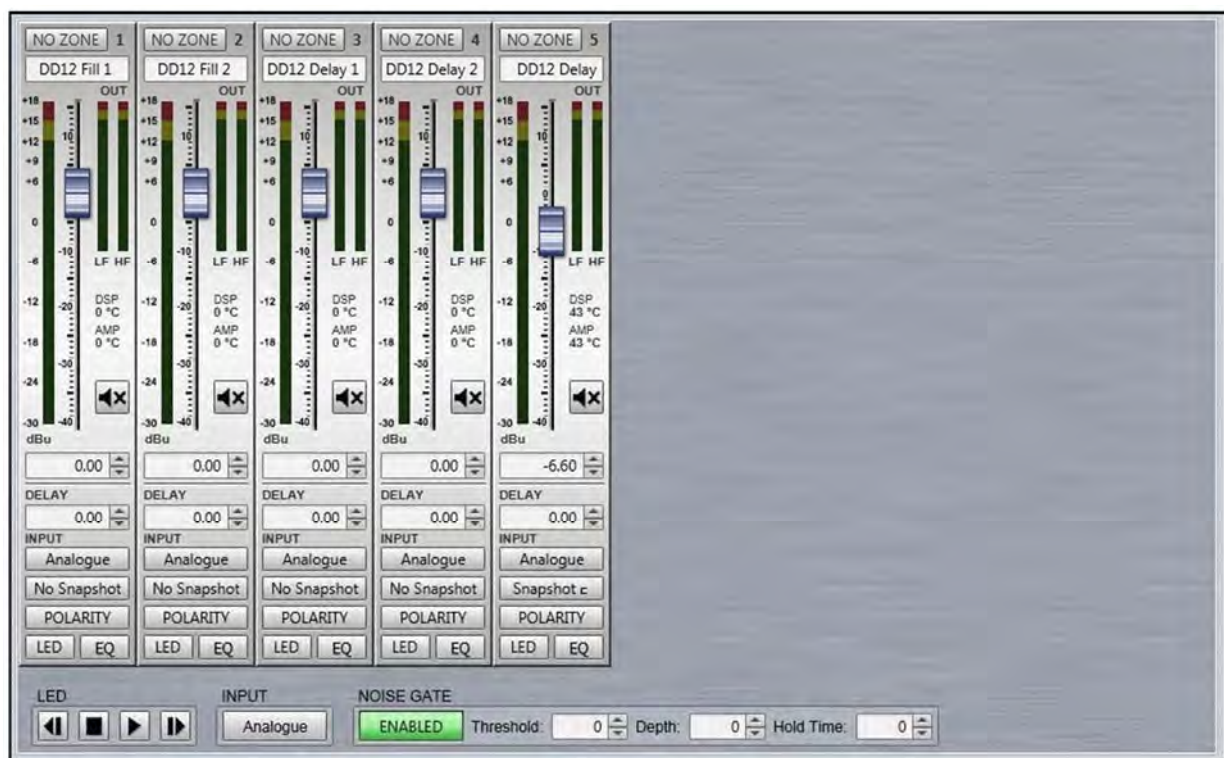

This gives an overview of the state of all DD12's allowing comprehensive monitoring of the system.

The box at the top will show any names that have been assigned to the cabinets by right clicking and selecting rename (or selecting and pressing F2 in the System Diagram; -

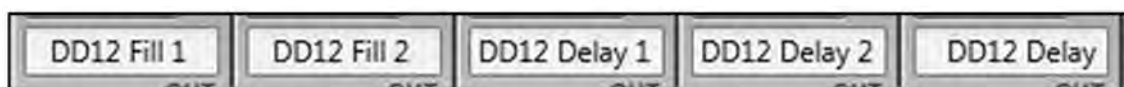

The gain fader allows gain adjustment from -40 to +15dB. Precise values can be entered by typing directly in the box below the fader or values can be scrolled up or down using the up/down buttons. The increments that the up/down buttons will step is determined in the Preferences section, by default it will be 0.25dB.

The mute button will mute the cabinet irrespective of the position of the gain fader and will turn red when active.

There is comprehensive metering available. The bargraph to the left of the fader shows input level up to the maximum before input clip of +18dBu. The smaller meters to the right show the amplifier output levels for both the low frequency amplifier driving the 12" driver and the high frequency amplifier driving the compression driver and show level prior to limit. If the levels reach the yellow segment you have reached the limiter threshold. A red segment indicated 3dB of gain reduction in the limiter.

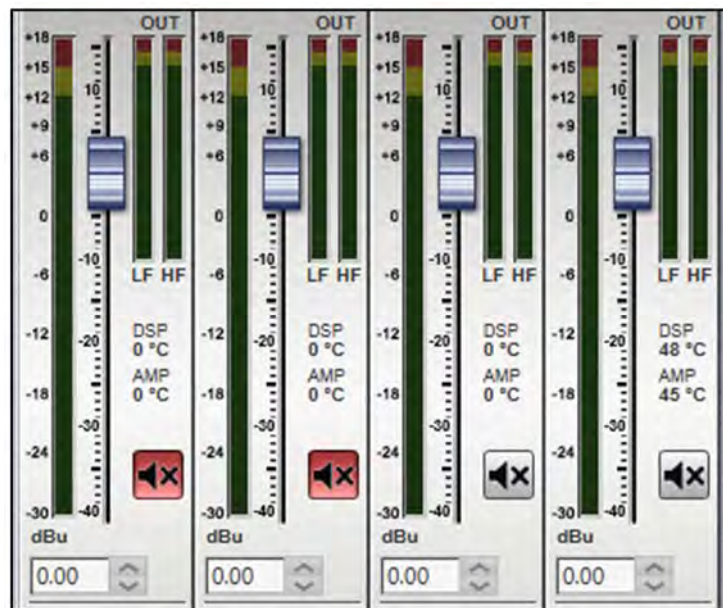

There is also a temperature read out showing the temperature of both the DSP and amplifier module; -

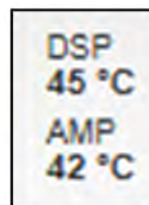

There is delay available which is very useful for time aligning the DD12 when used as an extra fill with a larger mains system. The maximum delay available is 1 second. Values can either be typed directly into the Delay field or scrolled up and down using the arrow buttons. These increase or decrease the delay in increments of 10µs.

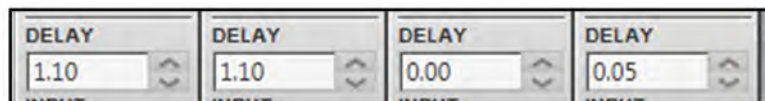

The Input allows the connection mode to be changed from the default which is Analogue to AES/EBU or Unet (not currently available) taking its feed from either AES left or AES right. This can either be done individually for each DD12 or globally using the Input switch at the bottom of the DD12 overview Window. A global change will bring up the flowing window; -

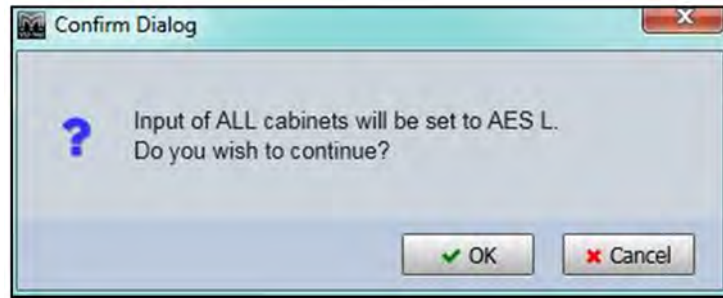

Click 'Cancel' if you have changed your mind or 'OK' to accept the change of input mode. All DD12's will display the new input selection.

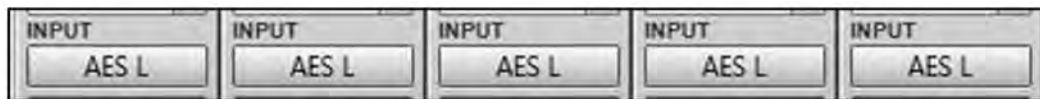

The Snapshot button gives access to either the load or save snapshot functions available from the right-click menu in the Project System Diagram. Clicking on the button will bring up both options as shows; -

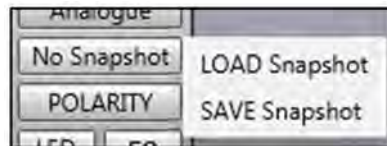

Clicking LOAD will bring up the Snapshot Menu with the currently active Snapshot shown highlighted in green; -



Clicking on a new Snapshot number or letter will prompt you to confirm your selection; -

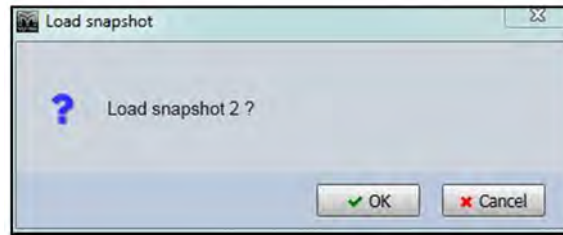

Clicking 'OK' will confirm the selection and the preset will load. The Preset select window can be closed. The currently active Snapshot is displayed on the Snapshot button; -



Clicking SAVE will bring up the Save snapshot menu in the same way as the right click option in the system overview page; -



Polarity will invert the phase of the cabinet. If in Show Mode a confirmation window will appear; -

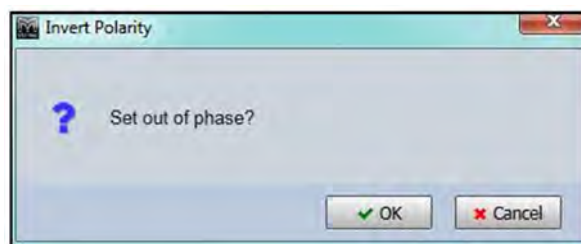

On clicking 'OK' the phase will be inverted and the Polarity button will turn green; -





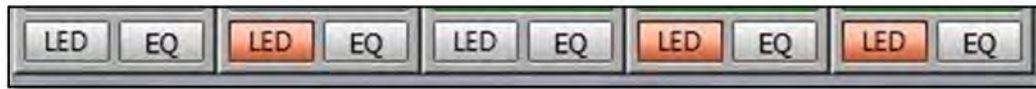

Clicking the LED button will illuminate the front grille LED to help identify the DD12 under control in multiple deployment applications. This can be done individually for any cabinet; -



Or globally using the LED controls at the bottom of the DD12 Overview window; -



Pressing the "play" arrow  will make the LEDs of all DD12s illuminate in sequence, cycling round continually until you click on the stop button . Note that the global LED switches will overwrite any LEDs which have been activated on an individual DD12. The back and forward buttons   allow manual cycling of all cabinet LEDs, each click will extinguish the currently illuminated LED and light the LED on the next or previous DD12.

## EQ

The EQ button will open the EQ tab for that particular DD12. The EQ window is virtually identical to all other Vu-Net controlled devices; -



The window has three sections, the buttons along the top, the graphic display window and the controls on the right of the window. First we will look at the buttons along the top.

First there are ten parametric EQ buttons plus the high pass filter; -



As you can see there are a number of colour variations for these buttons. Unused bands are pale blue until they are selected for editing by clicking on them in which case the colour goes to a brighter blue and the image shows the button depressed. Unused is defined as the gain left at 0dB. A red button indicates that the band has been bypassed, irrespective of whether any gain change has been made. Bypassed bands will change to a pale red when selected. Green buttons indicate a band that has either cut or boost applied, these will go a pale green when selected. Note that the high pass filter is always active so will always appear green.

The graphic view of the equalisation is a relatively standard frequency response graph; -

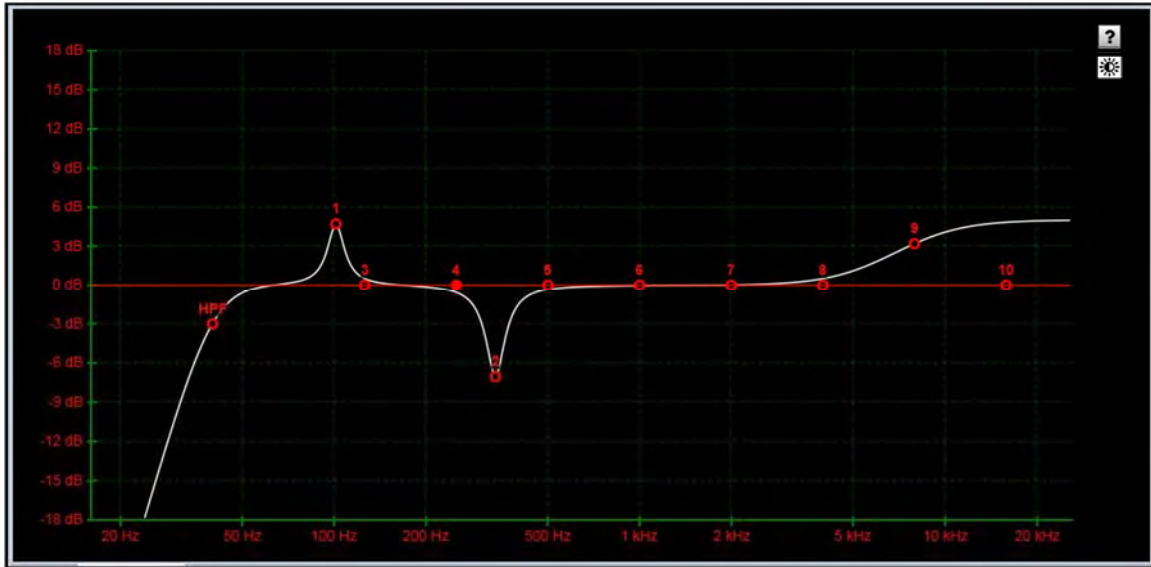

The horizontal axis is frequency in Hertz from 20Hz to 20KHz, the vertical axis is gain from -18dB up to +18dB. Colour coding is also used on the graph to represent the various modes.

First there are two traces, one red, and the other white. The red trace is the response of the band that is currently selected; the white trace is the overall response of the entire PEQ.

Each small red circle represents the position of each of the ten bands plus the high pass. For all of the EQ bands the position on the horizontal represents the EQ centre frequency, the vertical position is the cut or boost applied. A solid red circle is the currently selected band, any greyed-out band indicates that an EQ has been bypassed. The circle labelled "HP" identifies the cut-off frequency of the highpass filter.

In the right corner is this icon; -



This is used to cycle between standard and daylight modes. In daylight mode the display changes to look like this; -

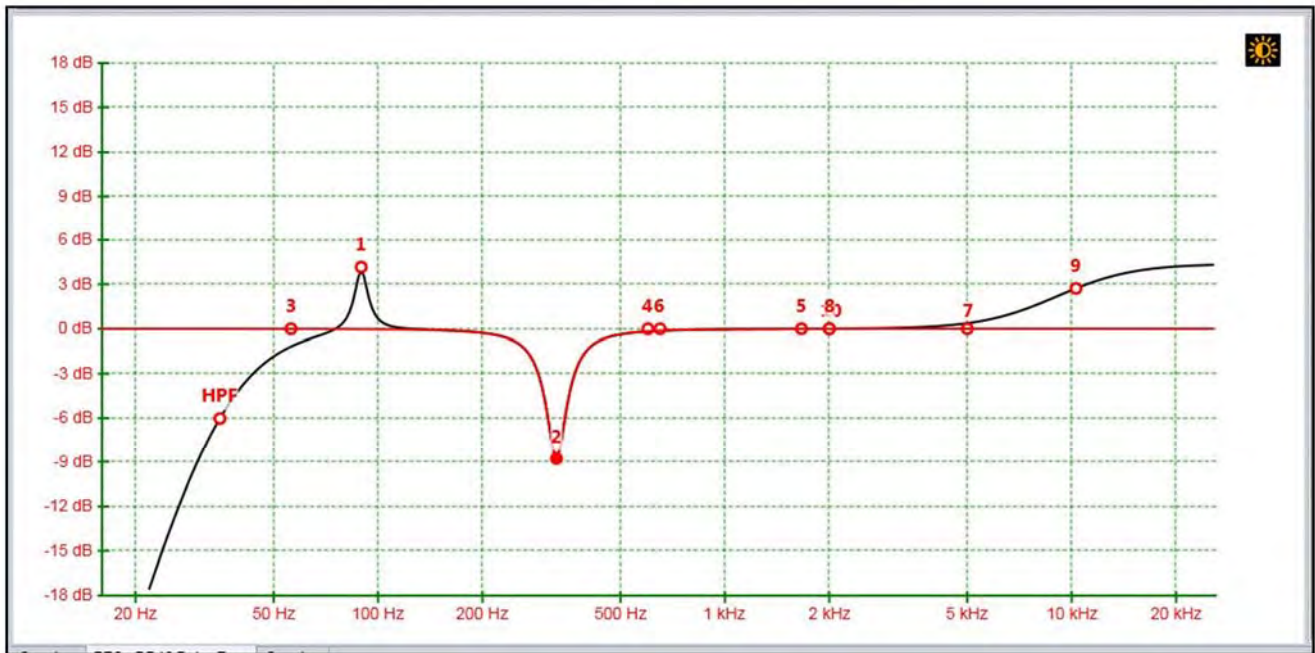

This is intended for use outdoors setting up a festival system where the normal display is difficult to view in bright sunlight. A further click on the icon will return to the default view.

In common with most PC controlled equalisation systems it is possible to make adjustments by dragging and dropping the filter curves. Left-click on any of the band rectangles and holding down the left mouse button, drag the icon horizontally to change the centre frequency or vertically to change the gain. Right-click and drag or Ctrl and drag up and down to adjust the filter Q factor. The graph will adjust and the audio adjustment will be made in real time.

The final section on the right of the window is the Properties panel; -



This shows all properties of the selected band. At the top are three buttons; -

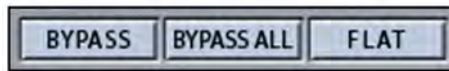

'BYPASS' bypasses the individual band you have selected turning the BYPASS button and the filter button red. 'BYPASS ALL' bypasses every band. 'FLAT' will instantly change the gain to 0dB.

Next is a Filter type. Click on this and the drop down shows the options for each filter band; -

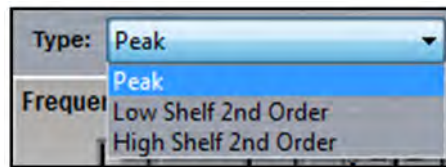

The default is 'Peak', a standard parametric EQ; the other options are 2<sup>nd</sup> order Low Shelf and 2<sup>nd</sup> order High Shelf.

Below are the three principal faders for adjusting the filter parameters; -

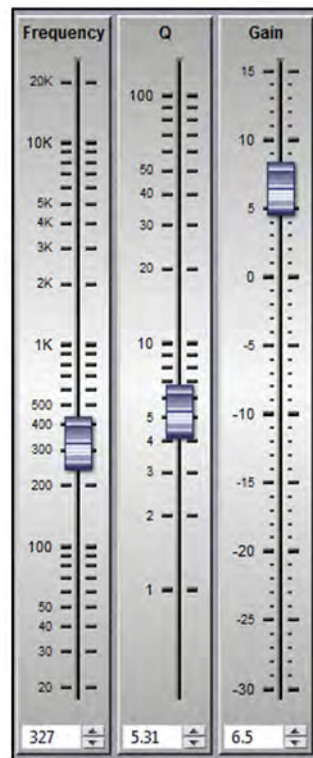

Parameters can be changed on the properties panel in three ways. The faders can be drag and dropped to a new value, the value can be scrolled up or down using the up/down buttons to the right of the value windows, and finally values can be directly typed into the value windows. The response graph will adjust according to the new values and vice versa, adjustments in the graph window will be reflected in the fader positions and values in the properties panel.

The High pass filter only has a single fader for the corner frequency. This may be adjusted in exactly the same way as the faders for the PEQ's. The 'Type' drop down offers three types of filter and slopes from 12dB up to 48dB per octave; -





To summarise, there are four ways to adjust filter parameters; -

1. Click and drag on the graph
2. Click and drag the properties faders
3. Use the up/down value buttons in the properties section
4. Directly type values into the value boxes.

Whilst this might seem over-versatility, it is intended to offer several options to suit the way that the system is being operated. If adjustments are being made with using a wireless tablet PC with a stylus whilst walking around a venue, certain options may be easier to use than if you were sitting at a desk with a mouse plugged in to the PC.

## Zones

DD12 has a unique method for zone selection. Any cabinet can be a member of any (or none) of the twenty zones available which are labelled A to T. To select a zone click on the Zone button at the top of the Overview page; -

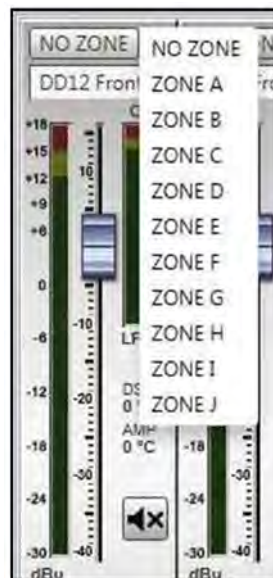

Click on the desired zone and it will be displayed on the zone button. The zones are colour coded to make it instantly obvious which cabinets are on the same zones. Colours are as follows; -

A is Blue	K is Lavender
B is Red	L is Brown
C is Green	M is Turquoise
D is Yellow	N is Dark Brown
E is Black	O is Flesh
F is Teal	P is Light Green
G is Deep Purple	Q is Violet
H is Moss Green	R is Sand
I is Pink	S is Crimson
J is Dull Green	T is Azure

All functions on cabinets in the same zone will be duplicated regardless of which cabinet in the zone is used to make adjustments. Note that all gain and delay parameters are *offset* ganged. If there is already a gain or delay value entered before a DD12 is added to a zone this will be retained and subsequent changes to a value to gain or delay on any cabinet in the same zone will increase or decrease all values according to any edits you make but will retain the offset between all values; -

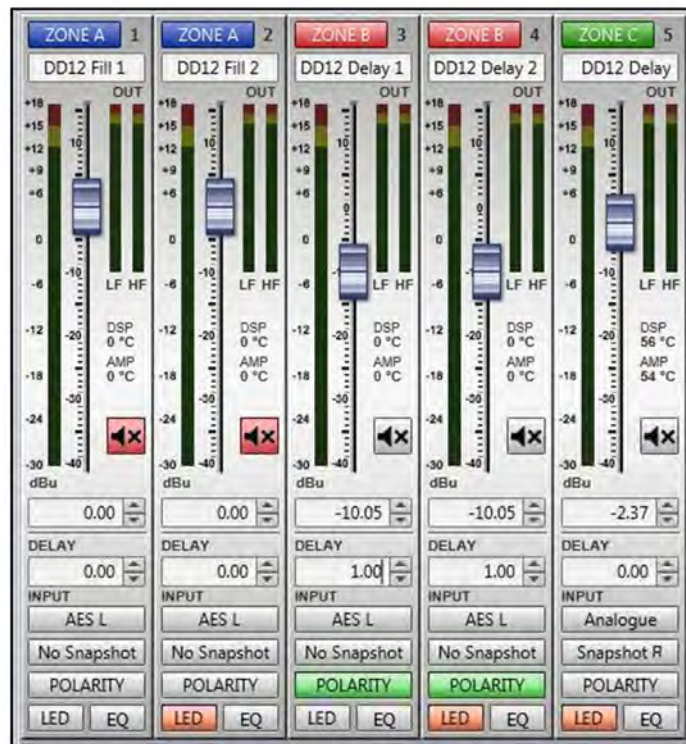

## Noise Gate

The DD12 has a noise gate that is applied globally to all DD12's in the project. This is controlled using the section at the bottom of the overview window; -

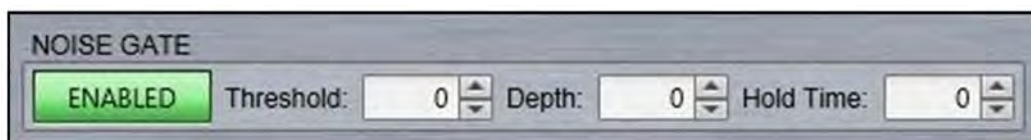

Once enabled the Threshold, Depth and Hold Time can be adjusted, either by manually typing a value or using the up/down arrows to scroll through values. The default values are Threshold at -67dB, Depth of 10dB and Hold time of 500ms.

## Ganging

In addition to zoning all functions, it is possible to gang sections of a DD12 such as all input or output parameters or even individual parameters. To create gangs, click on the Ganging button on the toolbar which opens the ganging window; -



A project with five DD12s appears like this; -

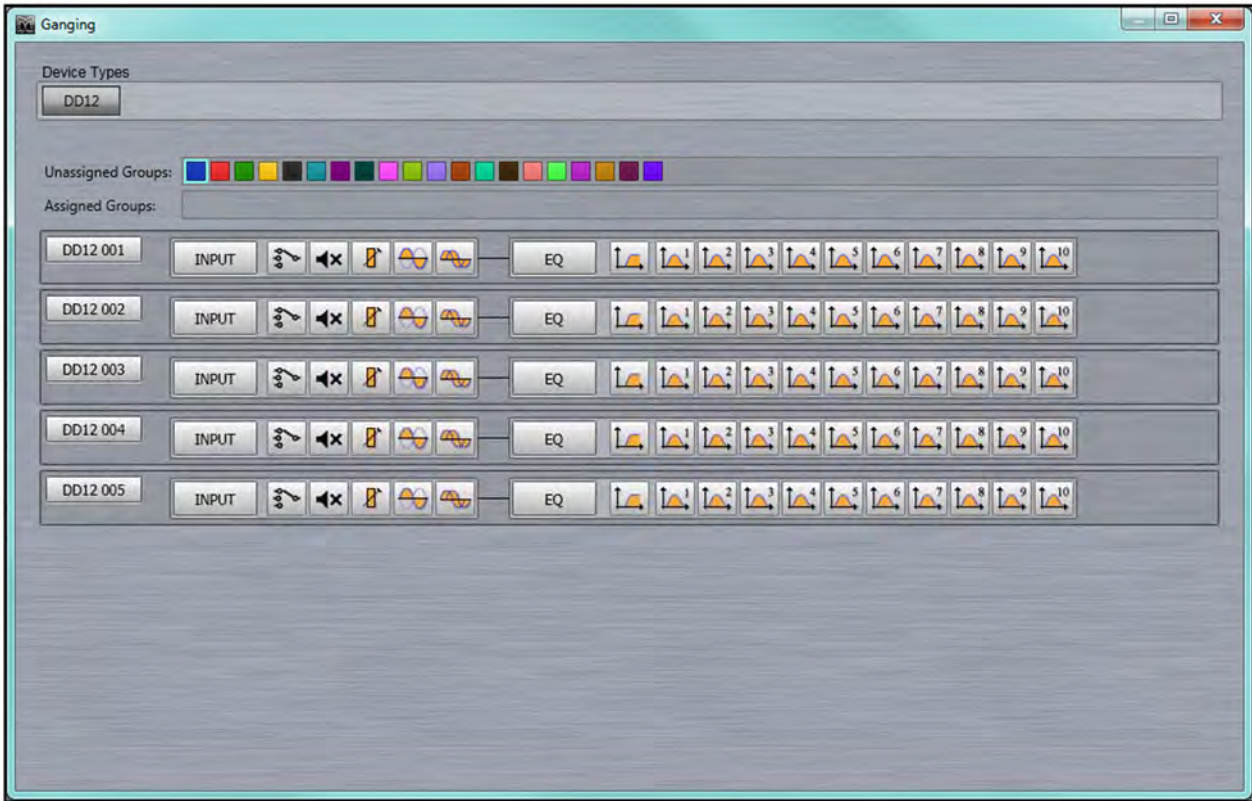

Entire product gangs which link all parameters can be created by first clicking on an unassigned group and then clicking on the label for each DD12 we wish to include. Here we have ganged 001 and 002 on the blue group, 003 and 004 on the Red; -

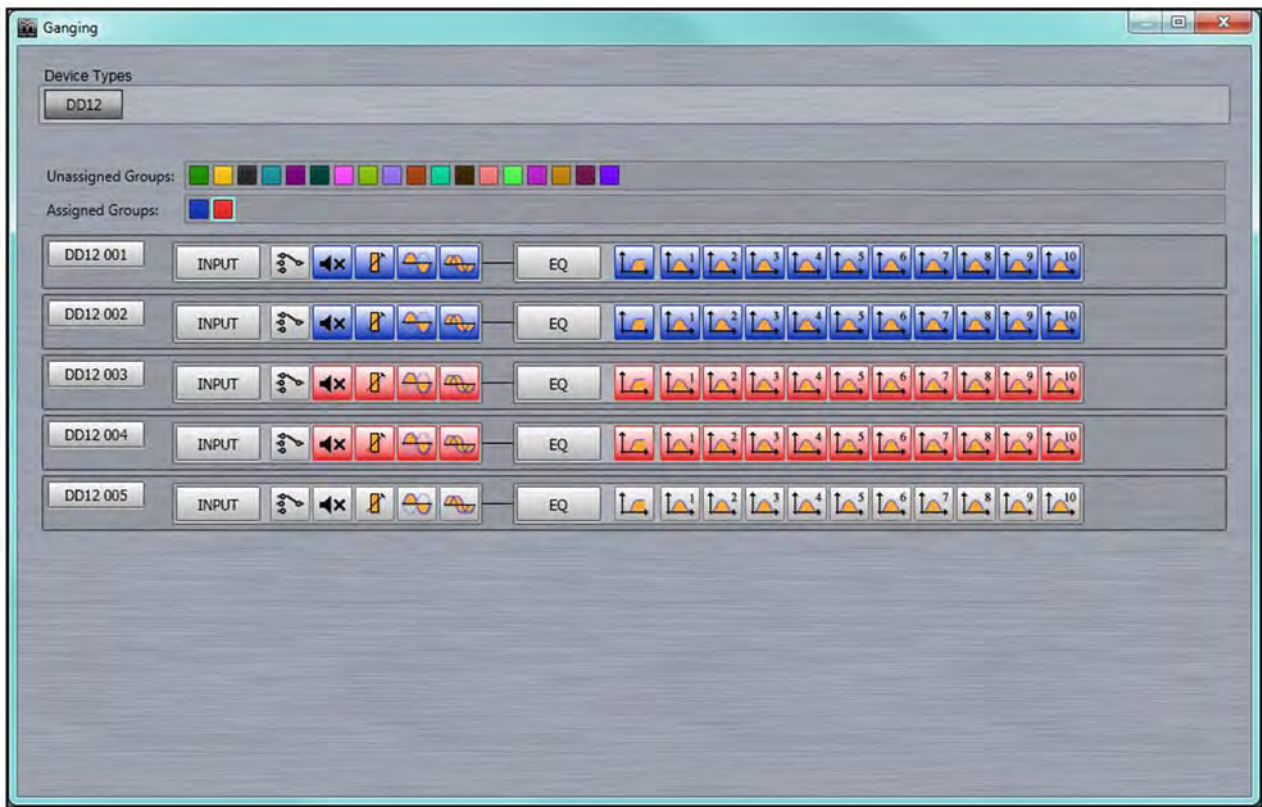

You can also gang entire inputs by clicking on the input button, all output EQ by clicking on the EQ button. Here we have ganged the inputs of 001 and 002, the output EQ on 003, 004 and 005, the gain on 003 and 004, the delay on 004 and 005 and the input source on all five cabinets; -

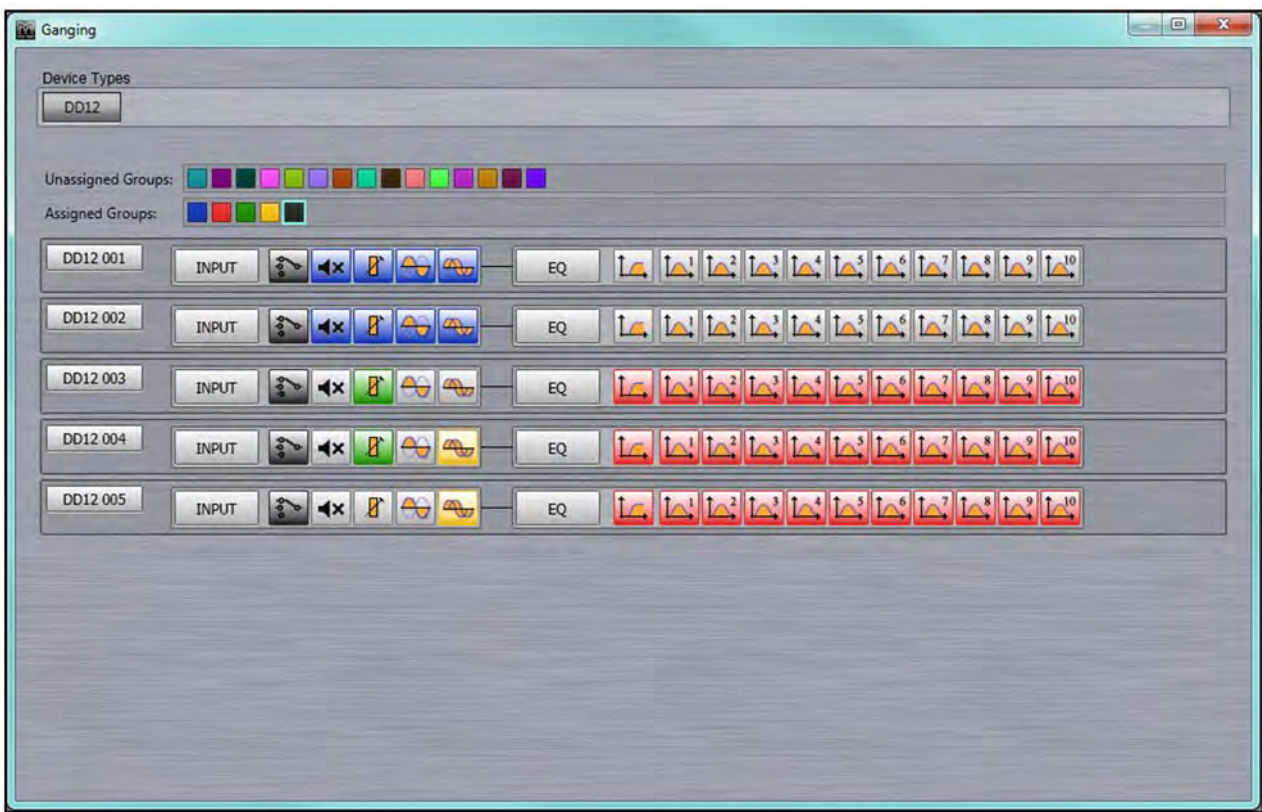

### PSX

PSX's are discovered in exactly the same way as any other device regardless of whether they are connected via a full U-Net network via either a Merlin or U-Hub or directly via USB. The Device discovery will show all connected cabinets; -

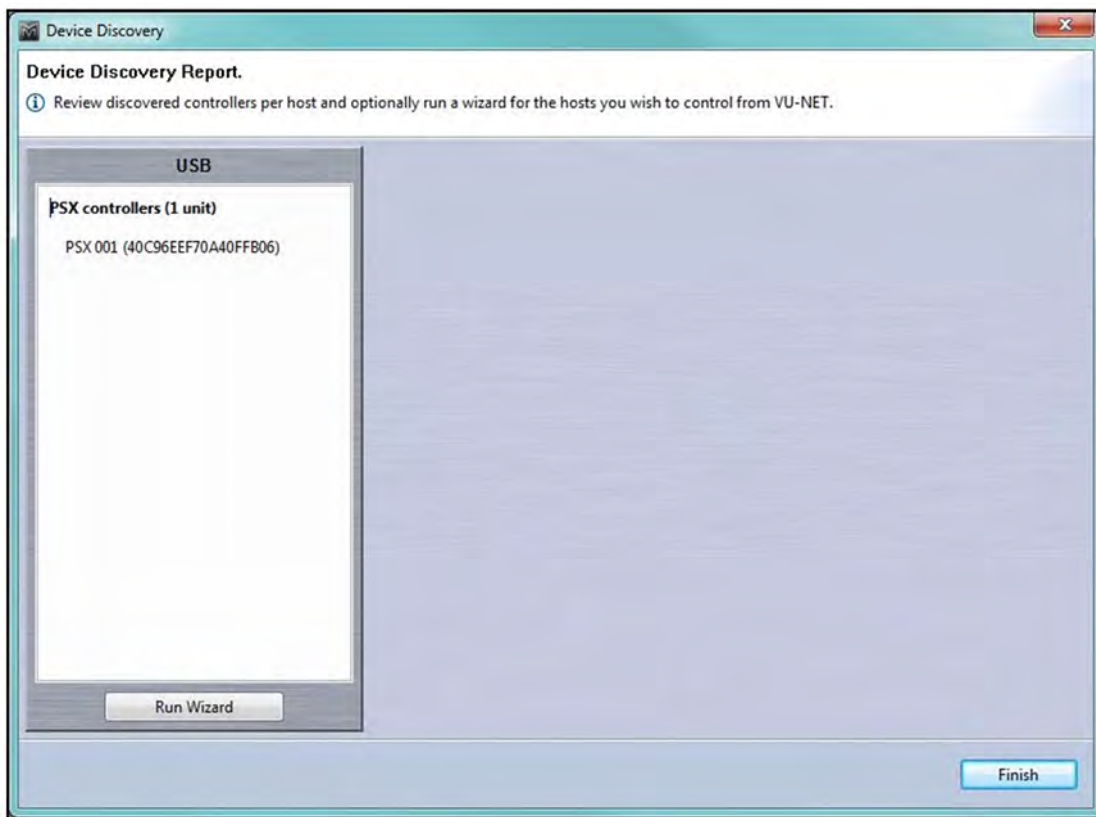

As there are no array-related options with the PSX the 'Run Wizard' merely synchronises with all connected cabinets so the software reflects the settings in the devices.

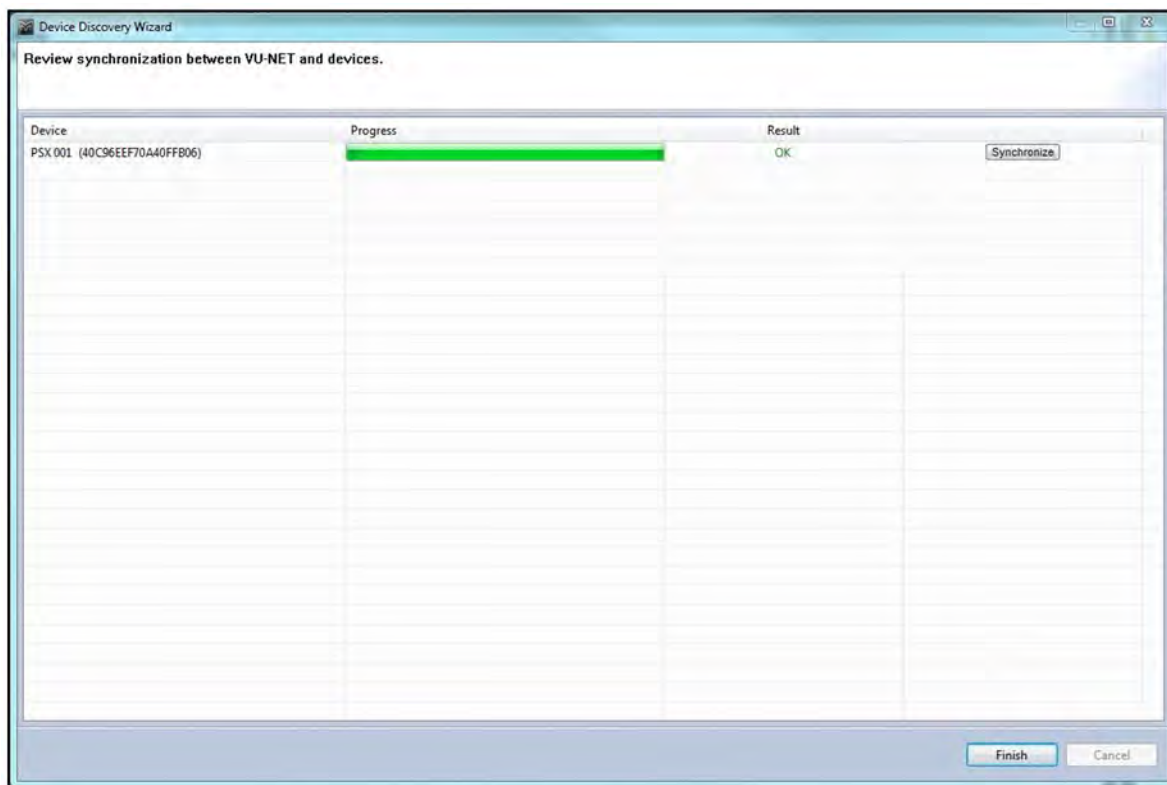

A system connected via USB will appear like this; -

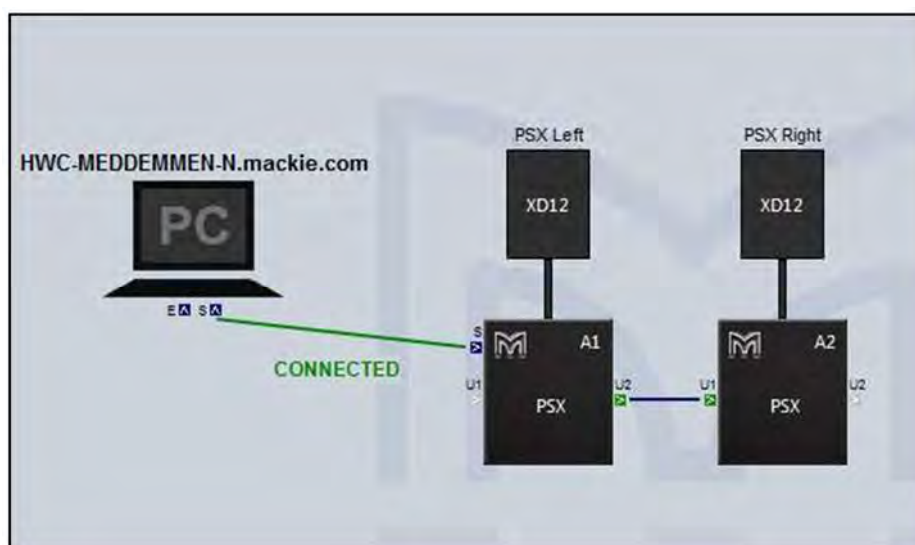

Each PSX icon in the overview screen features a Martin Audio logo. Double-clicking on this will illuminate the LED on the cabinet front grille to assist in identifying each PSX which is very useful when multiple units are deployed.

There are a number of functions available by right clicking on a cabinet icon; -

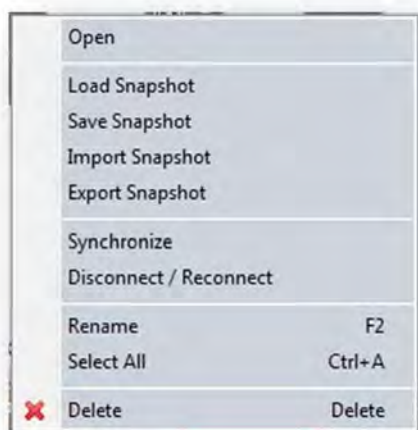

'Open' functions in exactly the same way as double clicking on the cabinet icon and opens the DD12 overview screen to allow detailed control and monitoring

'Load Snapshot' brings up the snapshot window allowing you to select with one of the factory or User snapshots if any have been created; -



Click on the snapshot number to choose the snapshot you need, you will be prompted to confirm; -



'Save Snapshot' allows you to store a configuration that you have created to one of the User Snapshot locations. There are 12 locations available; -



Click on the Snapshot letter for the location you wish to use and you will be prompted to ass a snapshot name; -

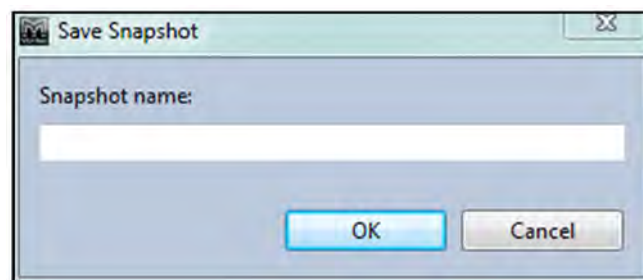

Type a name of up to 30 characters and the snapshot will be saved.

'Import Snapshot' allows you to recall a DD12 snapshot that has been exported to a file. Selecting Import brings up this window; -



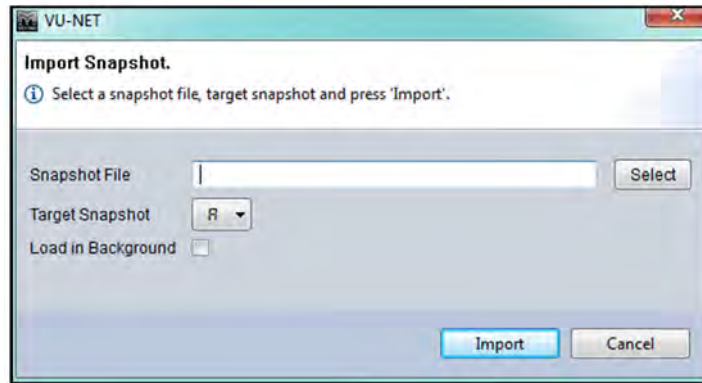

Click 'select' to navigate to the file location where you have stored DD12 Snapshot files. Next click on the target snapshot location within the User Locations, note that the imported file will overwrite any existing snapshot so if you need to retain any of those select a vacant location. Click 'Import' and the file will be imported and that snapshot immediately selected.

'Load in Background' allows you to load a file to a snapshot location of your choice and as long as you don't select the active snapshot location the file will be uploaded without disturbing the settings, even if the cabinet is in use passing audio.

'Export Snapshot' is how you create the DD12 .sn files which can be imported at future events. The Export windows appears like this; -

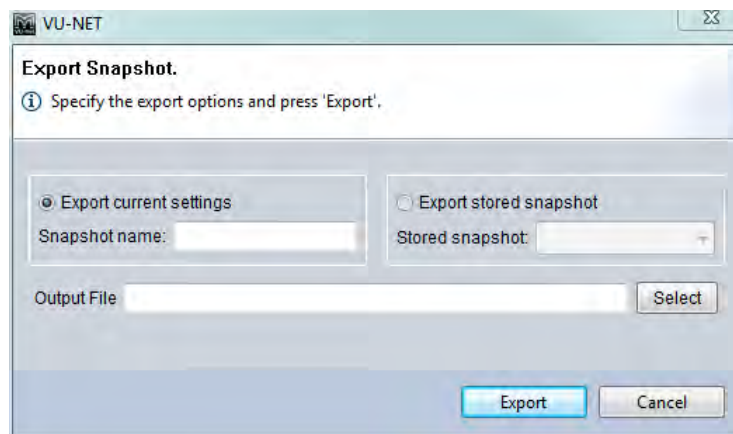

You can elect to export the current settings giving the file an appropriate name, or one of the existing snapshots. Selecting this option will allow you to select one of the stored snapshots from a drop-down list. The drop-down ignores any undefined snapshot locations; -

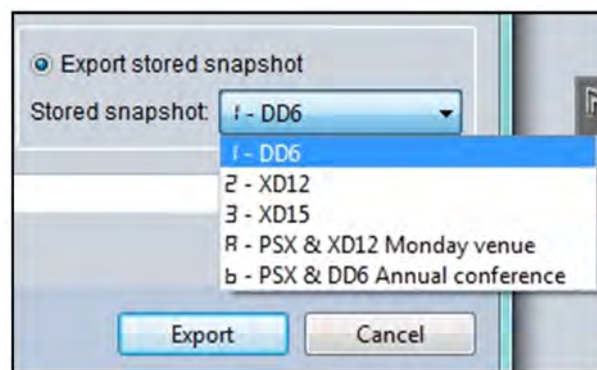

Click Select and navigate to a suitable location on your PC and give the file a suitable name, the file will automatically have a .sn file extension generated. Click 'Export' and the file will be stored.

'**Synchronise**' is a manual synchronise that duplicates the automatic synchronise that occurs when a DD12 is discovered to ensure that what is displayed in Vu-Net matches exactly the parameters stored within the cabinet DSP.

'**Disconnect/Reconnect**' allows you to disconnect and individual cabinet which will turn red once disconnected; -

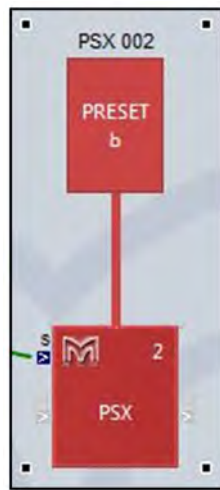

Selecting the same function will reconnect the cabinet and it will revert to the standard appearance.

'**Rename**' as with any other device allows the cabinet to be given a name of up to 30 characters; -

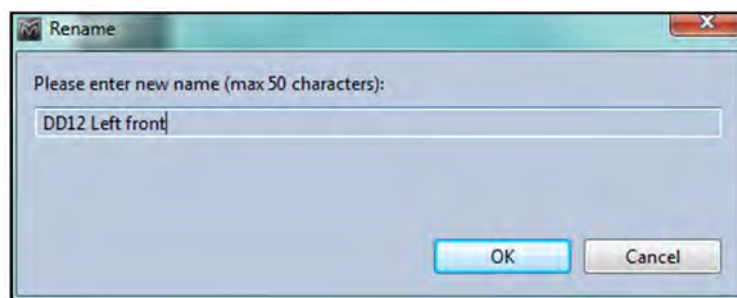

'**Select All**' selects all devices in the system Diagram, the keyboard shortcut for this is Ctrl + A.

'**Delete**' removes the selected DD12. You will be prompted with the following Window to confirm the delete; -

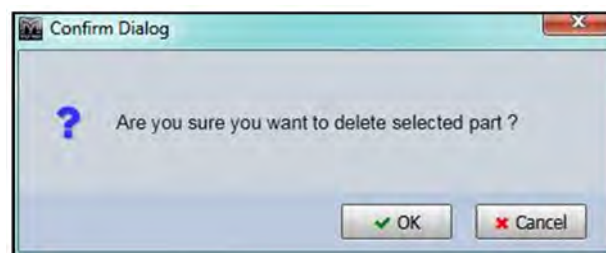

If you selected Delete accidentally or have changed your mind, click 'Cancel', otherwise click 'OK' and the DD12 will be removed from the project.

## Overview

Either double clicking or right clicking and selecting Open will bring up the overview option for the PSX which shows all PSXs in the project; -



This gives an overview of the state of all PSX's allowing comprehensive monitoring of the system.

The box at the top will show any names that have been assigned to the cabinets by right clicking and selecting rename (or selecting and pressing F2 in the System Diagram); -

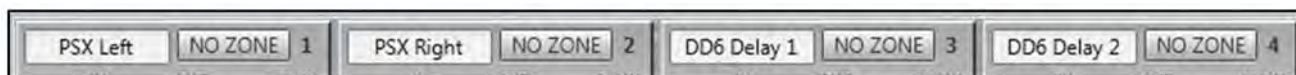

There are three gain faders, one for Input level and one each for control of the output of the internal sub and the external amplifier output. Each fader has a range of +15 to -40dB. Precise values can be entered by typing directly in the box below the fader or values can be scrolled up or down using the up/down buttons. The increments that the up/down buttons will step is determined in the Preferences section, by default it will be 0.25dB.

The mute button will mute the cabinet irrespective of the position of the gain fader and will turn red when active.

There is comprehensive metering available with a bargraph meter for input, Sub out and Main out. The input meter registers the level applied to the PSX up to the maximum of +18dB, the yellow and red segments indicating that the level is getting close to the maximum. The output meters indicate level prior to limit. The yellow segments indicate the onset of limiting; the red segment indicates 4dB of gain reduction.



There is also a temperature read out showing the temperature of both the DSP and amplifier module; -

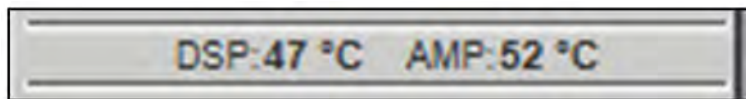

There is independent delay available for both the Sub and main outputs which is extremely useful for time aligning the PSX and the mid-top speaker that it is powering, particularly when used as a delay fill with a larger main system. The maximum delay available is 1 second. Values can either be typed directly into the Delay field or scrolled up and down using the arrow buttons. These increase or decrease the delay in increments of 10µs.

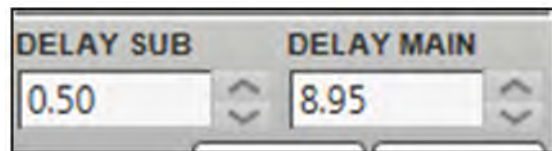

Polarity can be inverted independently for the sub and main outs. When in Show Mode a confirmation window will appear; -

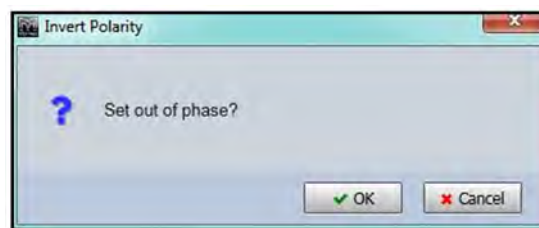

On clicking 'OK' the phase will be inverted and the Polarity button will turn green; -



The Snapshot button acts in the same way as the Load and Save Snapshot functions which are available from the right-click menu in the Project System Diagram. Clicking on the Snapshot button will bring up the option to Load or Save a snapshot; -

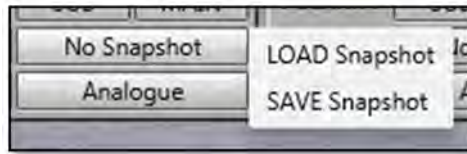

LOAD Snapshot brings up the Snapshot Menu with the currently active Snapshot shown highlighted in green; -



Clicking on a new Preset will prompt you to confirm your selection; -

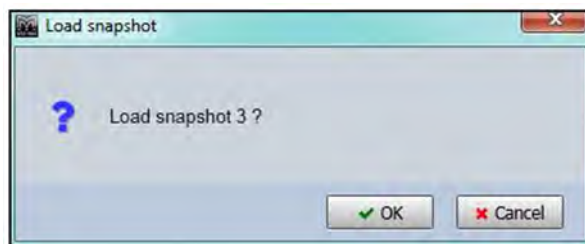

Clicking 'OK' will confirm the selection and the Snapshot will load. The Snapshot select window can be closed. The currently active Snapshot is displayed on the Preset button; -



Clicking on SAVE Snapshot brings up the Save snapshot window; -



Click on the Snapshot letter for the location you wish to use and you will be prompted to assign a snapshot name; -

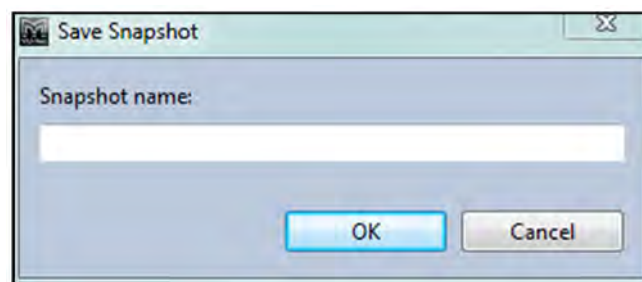

Type a name of up to 30 characters and the snapshot will be saved.

The Input allows the connection mode to be changed from the default which is Analogue to AES/EBU taking its feed from either AES left or AES right or a "split" mode which feeds AES Left to the Sub and AES Right to the Main out thus allowing individual control from two sends. This can either be done individually for each PSX or globally using the Input switch at the bottom of the PSX overview Window. A global change will bring up the following window; -

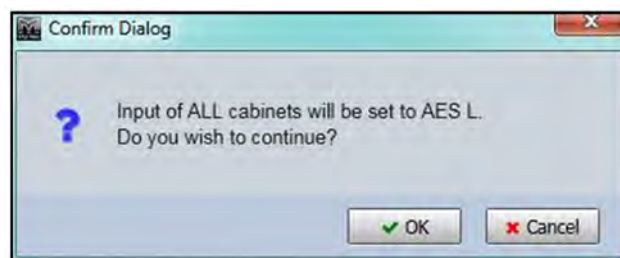

Click 'Cancel' if you have changed your mind or 'OK' to accept the change of input mode. All PSX's will display the new input selection.







Clicking the LED button will illuminate the front grille LED to help identify the DD12 under control in multiple deployment applications. This can be done individually for any cabinet; -



Or globally using the LED controls at the bottom of the PSX Overview window; -



Pressing the "play" arrow  will make the LEDs of all PSXs illuminate in sequence, cycling round continually until you click on the stop button . Note that the global LED switches will overwrite any LEDs which have been activated on an individual PSX. The back and forward buttons   allow manual cycling of all cabinet LEDs, each click will extinguish the currently illuminated LED and light the LED on the next or previous PSX.

## EQ

Clicking on the EQ button will bring up an EQ Window virtually identical to other Vu-Net controlled devices; -

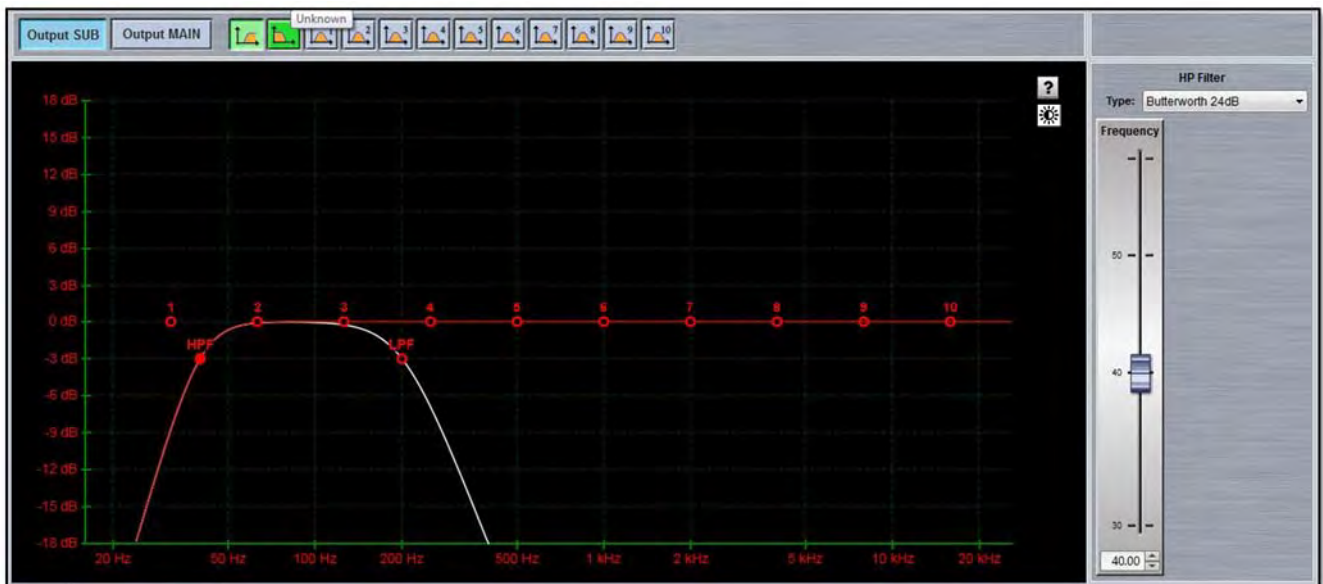

The button in the top left corner of the window select EQ for the Sub or for the auxillary amplifier output, this is the Aux output;



The window has three sections, the buttons along the top, the graphic display window and the controls on the right of the window. First we will look at the buttons along the top.

First there are ten parametric EQ buttons plus the high pass filter for both EQ windows and low pass filter for the Sub EQ; -



As you can see there are a number of colour variations for these buttons. Unused bands are pale blue until they are selected for editing by clicking on them in which case the colour goes to a brighter blue and the image shows the button depressed. Unused is defined as the gain left at 0dB. A red button indicates that the band has been bypassed, irrespective of whether any gain change has been made. Bypassed bands will change to a pale red when selected. Green buttons indicate a band that has either cut or boost applied, these will go a pale green when selected. Note that the high pass filter is always active so will always appear green.

The graphic view of the equalisation is a relatively standard frequency response graph; -

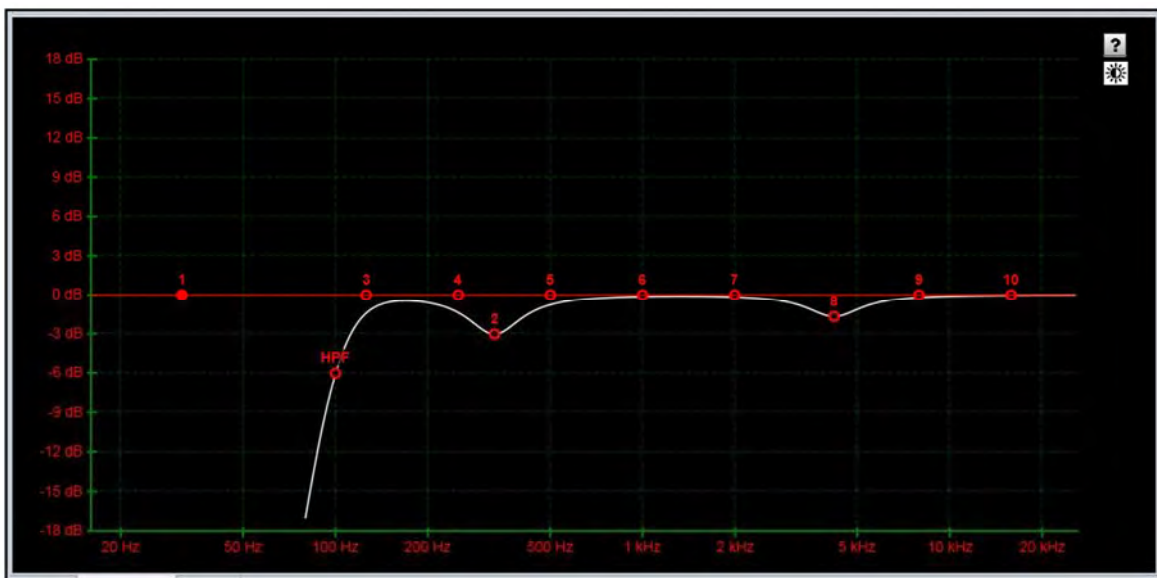



The horizontal axis is frequency in Hertz from 20Hz to 20KHz, the vertical axis is gain from -18dB up to +18dB. Colour coding is also used on the graph to represent the various modes.

First there are two traces, one red, and the other white. The red trace is the response of the band that is currently selected; the white trace is the overall response of the entire PEQ.

Each small red circle represents the position of each of the ten bands plus the high pass. For all of the EQ bands the position on the horizontal represents the EQ centre frequency, the vertical position is the cut or boost applied. A solid red circle is the currently selected band, any greyed-out band indicates that an EQ has been bypassed. The circle labelled "HP" identifies the cut-off frequency of the highpass filter.

In the right corner is this icon; -



This is used to cycle between standard and daylight modes. In daylight mode the display changes to look like this; -



This is intended for use outdoors setting up a festival system where the normal display is difficult to view in bright sunlight. A further click on the icon will return to the default view.

In common with most PC controlled equalisation systems it is possible to make adjustments by dragging and dropping the filter curves. Left-click on any of the band rectangles and holding down the left mouse button, drag the icon horizontally to change the centre frequency or vertically to change the gain. Right-click and drag or Ctrl and drag up and down to adjust the filter Q factor. The graph will adjust and the audio adjustment will be made in real time.

The final section on the right of the window is the Properties panel; -

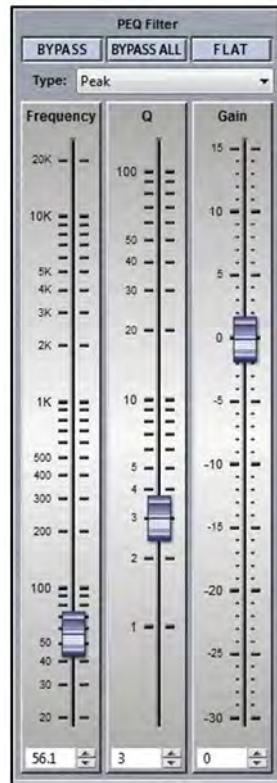

This shows all properties of the selected band. At the top are three buttons; -

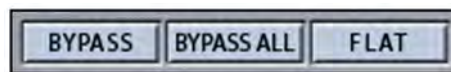

BYPASS bypasses the individual band you have selected turning the BYPASS button and the filter button red. BYPASS ALL bypasses every band. FLAT will instantly change the gain to 0dB.

Next is a Filter type. Click on this and the drop down shows the options for each filter band; -

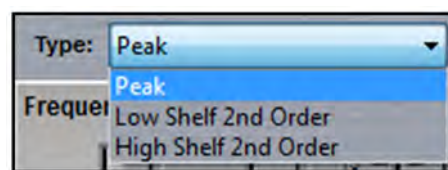

The default is 'Peak', a standard parametric EQ; the other options are 2<sup>nd</sup> order Low Shelf and 2<sup>nd</sup> order High Shelf.

Below are the three principal faders for adjusting the filter parameters; -

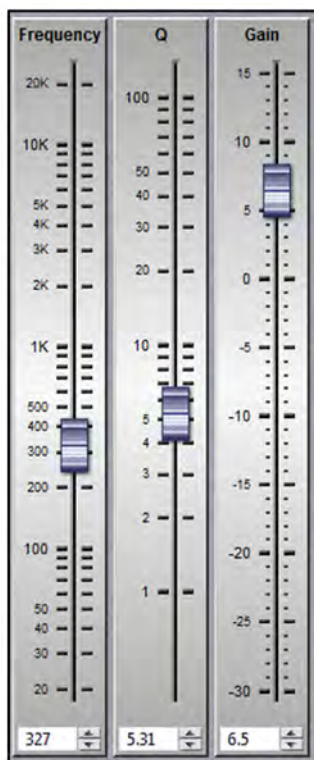

Parameters can be changed on the properties panel in three ways. The faders can be drag and dropped to a new value, the value can be scrolled up or down using the up/down buttons to the right of the value windows, and finally values can be directly typed into the value windows. The response graph will adjust according to the new values and vice versa, adjustments in the graph window will be reflected in the fader positions and values in the properties panel.

The High and Low pass filters only has a single fader for the corner frequency. This may be adjusted in exactly the same way as the faders for the PEQ's. The 'Type' drop-down for the high pass offers two types of filter and slopes from 24dB to 48dB per octave, for the low pass Butterworth, Bessel and Linkwitz Riley are available with slopes from 6 to 48dB per octave. The high pass for the main out is 48dB per octave Linkwitz Riley only.

To summarise, there are four ways to adjust filter parameters; -

1. Click and drag on the graph
2. Click and drag the properties faders
3. Use the up/down value buttons in the properties section
4. Directly type values into the value boxes.

Whilst this might seem over-versatility, it is intended to offer several options to suit the way that the system is being operated. If adjustments are being made with the Lenovo tablet PC in tablet mode with the stylus whilst walking around a venue, certain options may be easier to use than if you were sitting at a desk with a mouse plugged in to the PC.

The Main out also has a limiter to protect the connected mid-top cabinet from excessive power. This is located at the top right of the EQ window above the properties section; -

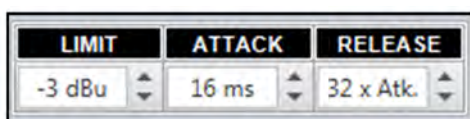

The Limit is the threshold point in dB and can be adjusted from -18dBu to +2dBu. The Attack time can be adjusted from 0.3ms up to 90ms and the release is a factor of the attack time, either x2, x4, x8, x16, x32 or x64. When using factory snapshots the values will suit the DD6, XD12 or XD15, when using other speakers you can edit the values to suit the speaker and these will be stored along with all other parameters if saves as a user snapshot.

## Zones

PSX has a very simple method for assigning cabinets to zones which will gang all parameters together. Any cabinet can be a member of any (or none) of the ten zones available which are labelled A to T. To select a zone click on the Zone button at the top of the Overview page; -

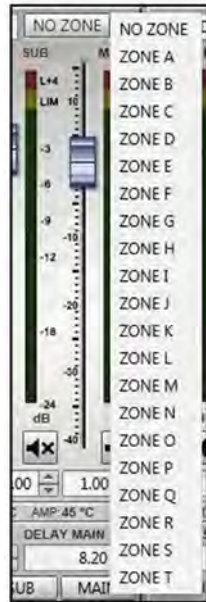

Click on the desired zone and it will be displayed on the zone button. The zones are colour coded to make it instantly obvious which cabinets are on the same zones. Colours are as follows; -

A is Blue	K is Lavender
B is Red	L is Brown
C is Green	M is Turquoise
D is Yellow	N is Dark Brown
E is Black	O is Flesh
F is Teal	P is Light Green
G is Deep Purple	Q is Violet
H is Moss Green	R is Sand
I is Pink	S is Crimson
J is Dull Green	T is Azure

All functions on cabinets in the same zone will be duplicated regardless of which cabinet in the zone is used to make adjustments. Note that all gain and delay parameters are *offset* ganged. If there is already a value entered before adding a PSX to a zone this will be retained and subsequent changes to gain or delay to any cabinet in the same zone will increase or decrease all values according to any edits you make but will retain the offset between all values; -

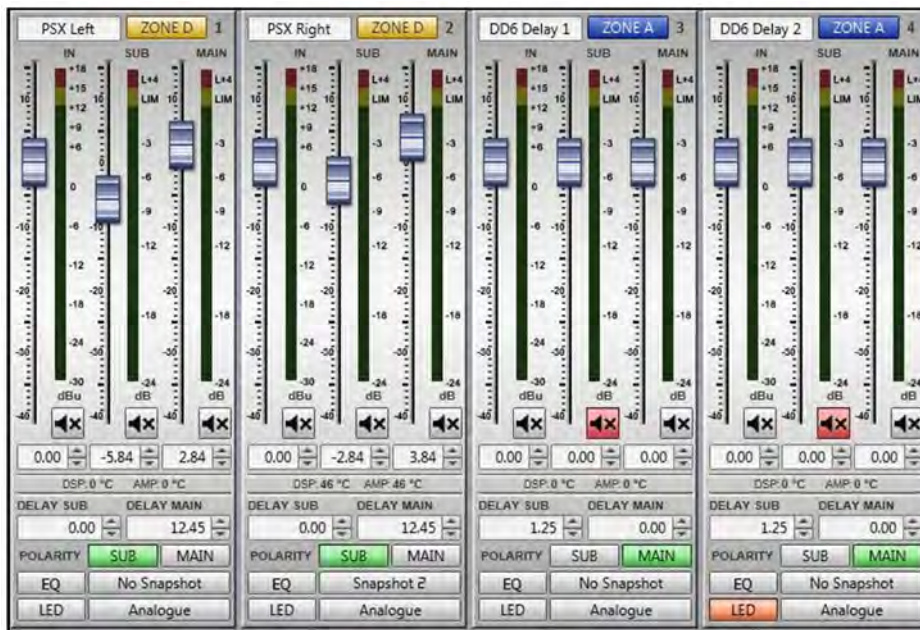

### Ganging

In addition to zoning which gangs all parameters, the ganging function can be used to gang all functions, groups of parameters such as inputs or outputs, or even individual parameters. The ganging window is opened using the button on the toolbar; -



The window will appear as follows; -

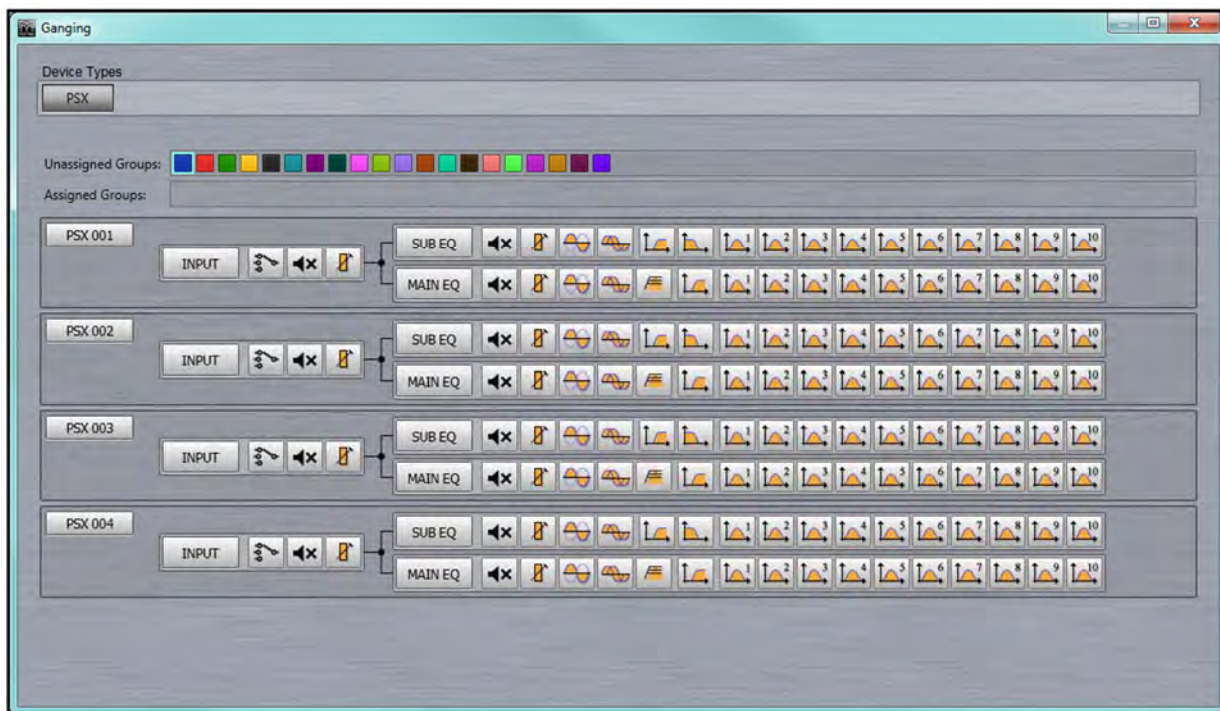

A gang is created by clicking on one of the unassigned groups (or an assigned group if you wish to add more parameters to an existing gang) and clicking on the functions that you wish to group. If you click on the cabinet name all parameters will be ganged

which is exactly the same as adding the cabinet to a zone from the main PSX Window. You can gang all input functions by clicking on **Input**, all output parameters by clicking on **Sub EQ** or **Main EQ** (not that the two outputs on each PSX cannot be ganged together as they have fundamentally different functions.). Individual parameters can be ganged by clicking on the parameter icon. You can also remove individual parameters from a gang by clicking after it has been ganged. For example, if all parameters have been ganged as would be the case if a cabinet has been assigned to a zone, you can click on say the mute icon for both outputs so all parameters such as the gain, delay and EQ will track but with individual mute available for all outputs. Here are two PSX, the first is assigned to zone A, the second was also assigned to Zone A but has both output Mutes un-ganged; -



Here is a more complex example with both PSX001 and 002 ganged with Mute un-ganged. PSX003 and 4 have their inputs ganged but with just the EQ on the outputs ganged and with all four having their input source ganged together; -

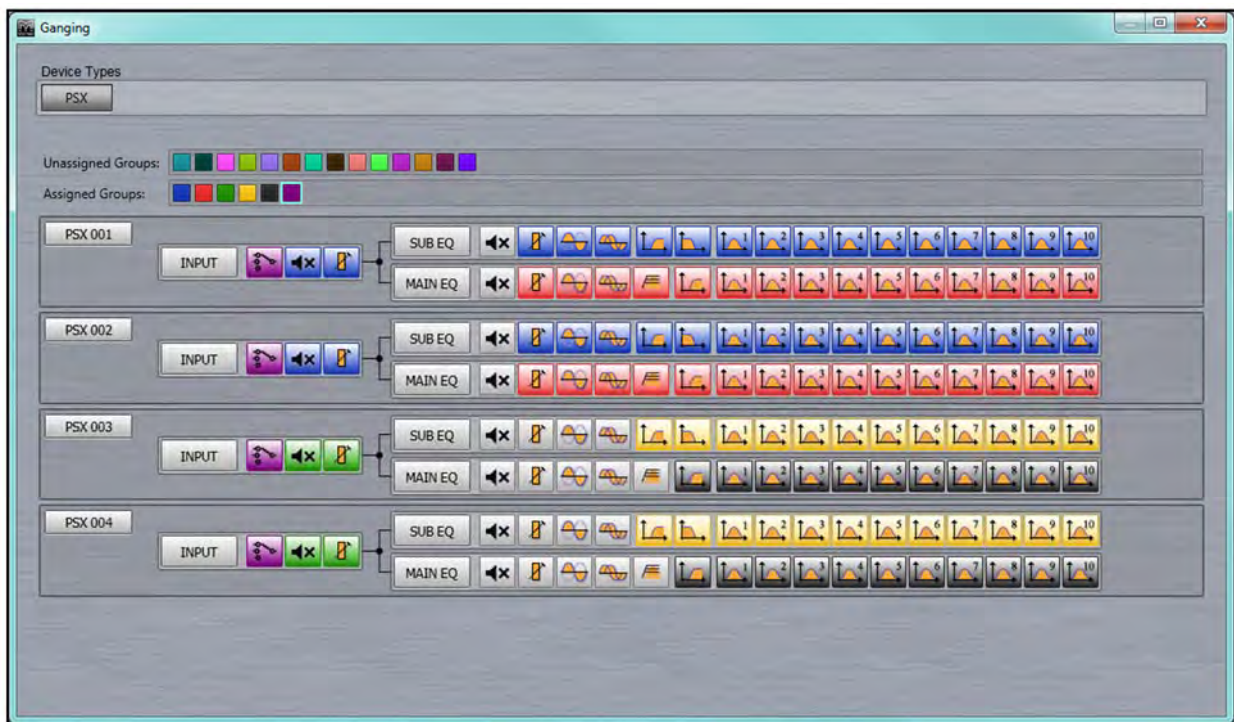

Note that when a cabinet has a gang assigned that is anything other than a full gang of all functions, the zone button will change from displaying the zone letter and colour to "User Defined"; -



## Noise Gate

The PSX has a noise gate that is applied globally to all DD12's in the project. This is controlled using the section at the bottom of the overview window; -

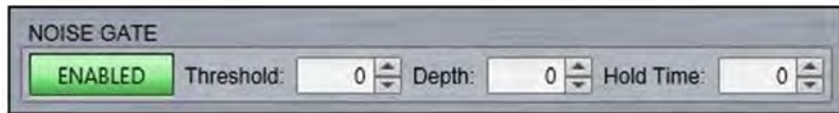

Once enabled the Threshold, Depth and Hold Time can be adjusted, either by manually typing a value or using the up/down arrows to scroll through values. The default values are Threshold at -67dB, Depth of 10dB and Hold time of 5000ms.

## CDD Live

Whilst connections to CDD live are made directly over Ethernet, Speakers from the range are discovered in the same way as other devices and will be discovered at the same time as any other products connected to the network whether via a Merlin, U-Hub and a U-Net network or USB for MLA Mini, DD12 or PSX.

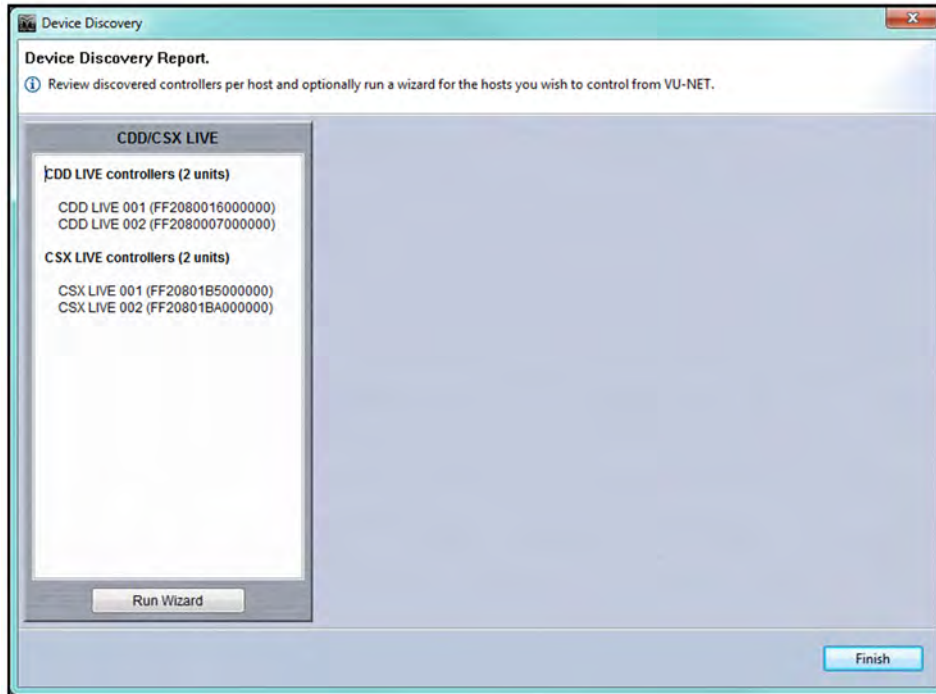

There are no array configuration options so clicking on 'Run Wizard' simply synchronises the cabinets with Vu-Net so that what is displayed in the application is exactly the configuration of the connected cabinets; -

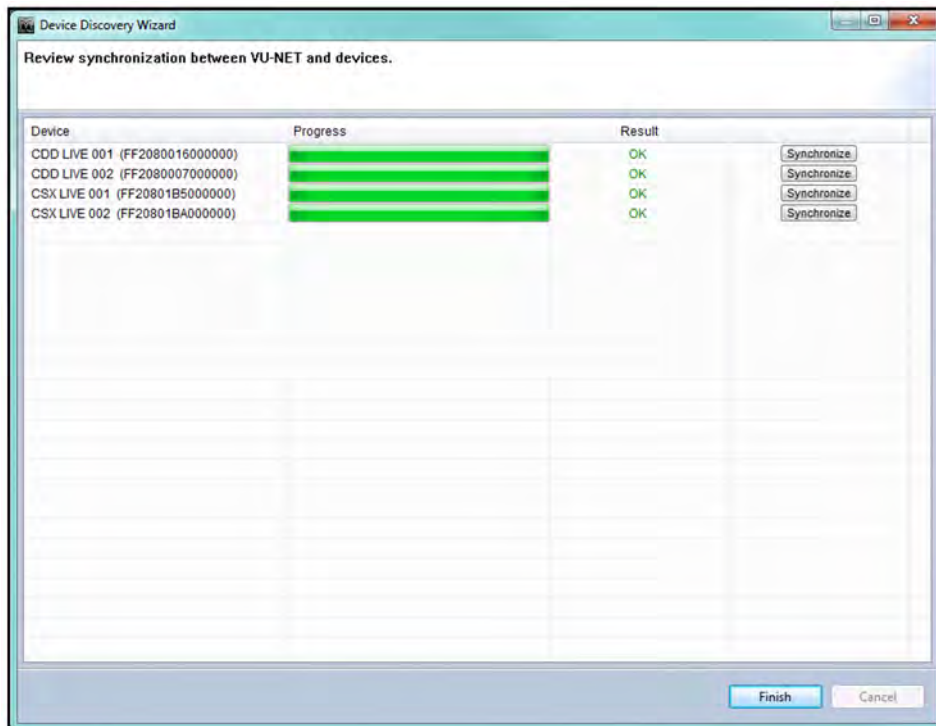

Once discovered the range will appear in Vu-Net like this; -



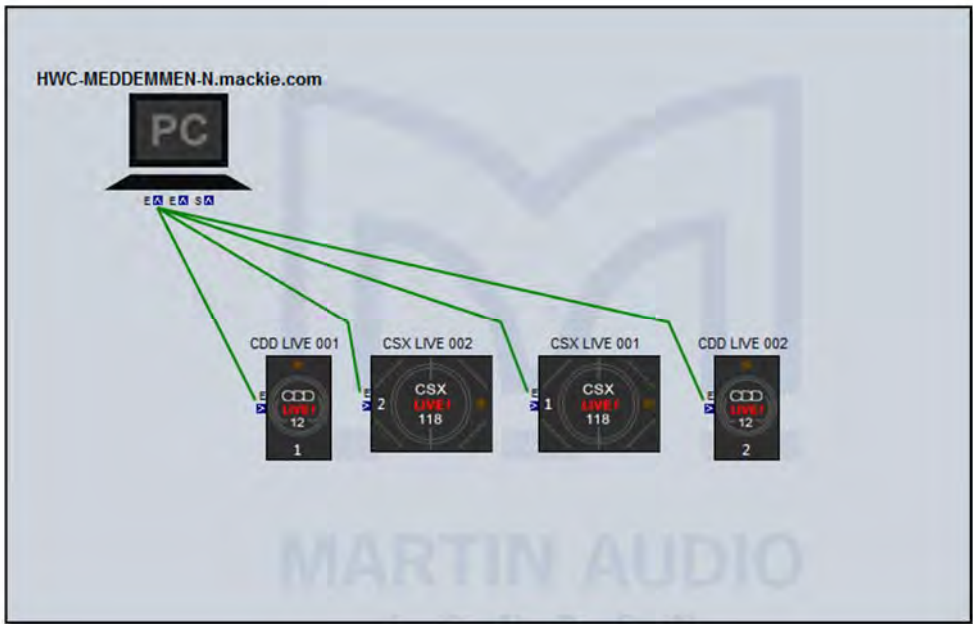

Each CDD Live device will be shown as an icon which includes the front grille LED. If you click on the cabinet to select it you can then click on the LED which will illuminate on the icon and on the speaker to make it easy to identify which cabinets you are controlling, useful particularly when you are arranging the overview screen in Vu-Net to represent the physical positioning of the system; -



Right clicking on any of the speakers brings up a number of menu options; -

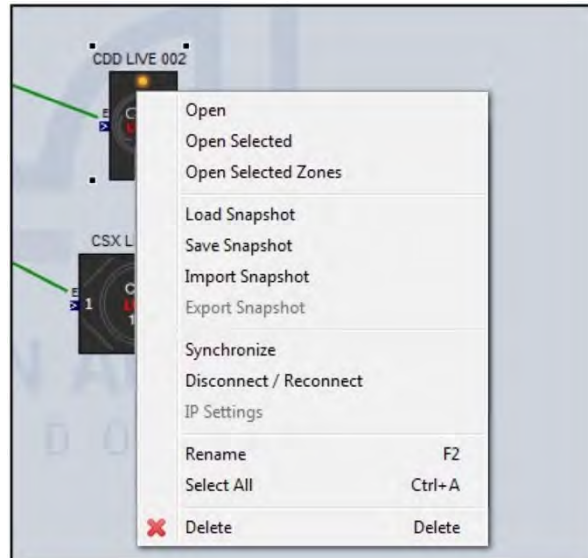

'Open' has exactly the same function as double clicking on the speaker icon to open the full control window. This will open the selected CDD-Live and all other CDD-Live in the same zone. If no zone has been selected, it will open all other CDD-Live with no zone allocated.

**Open selected** will open just the CDD-Live that have been selected by clicking and dragging around several speakers in the system diagram, or clicking on one CDD-Live, holding the shift key and clicking on others. It will open all selected irrespective of which zones they are in

**Open selected Zones** will open all CDD-Live selected as mentioned above plus all other CDD-Live in the same zone(s) as those selected.

'Load Snapshot' opens the Snapshot window allowing you to recall any of the three Factory Snapshots or the fourth User Snapshot; -



'Save Snapshot' is the function used to store parameters that you have edited to the User Location "U". This location can be recalled using the Load Snapshot command or by selecting Snapshot 4 using the button on the speaker connector panel. To store a Snapshot once you have made all the parameter changes that you need, select 'Save Snapshot', you will see this window; -

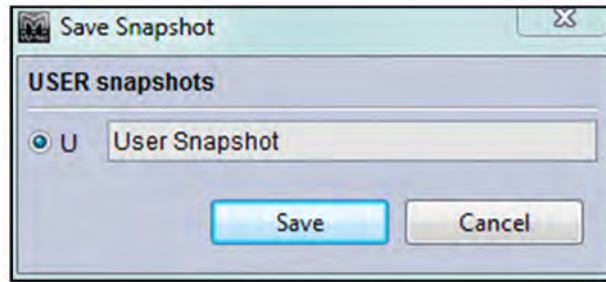

Click 'Save' and your setting are now stored and can be recalled when required.

'**Import Snapshot**' allows you to import a snapshot previously stored as a file on your PC. Selecting this option will open the following Window; -

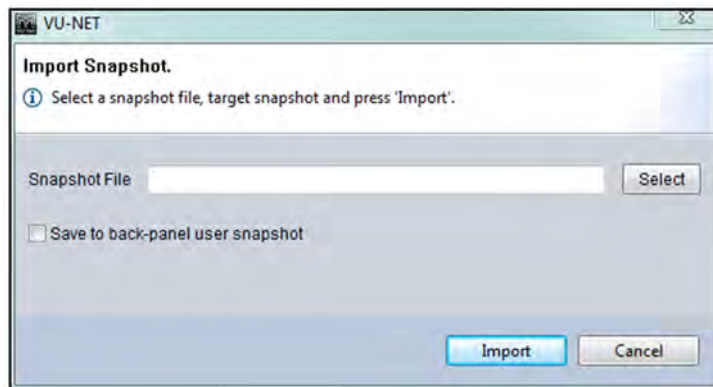

Click on the 'Select' button to navigate to the location on your PC where your CDD-Live files are located. If you would like to store the imported snapshot directly to the User Snapshot location so it can be stored and selected in future without a PC connected click on the 'Save to back-panel user snapshot' box. If this is left un-checked the snapshot settings will be imported but will be lost when a new snapshot is selected from the rear panel switch.

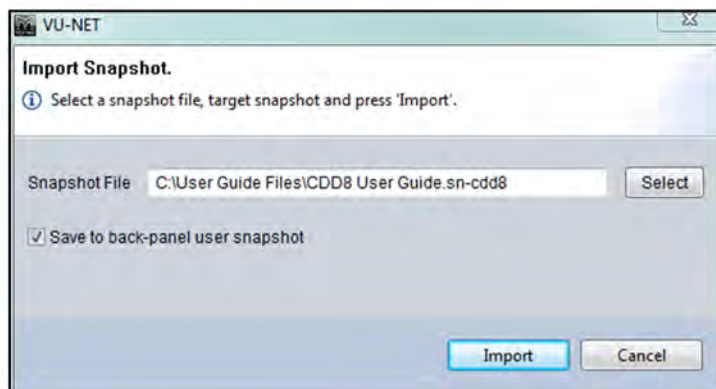

Click 'Import' and the snapshot is downloaded from your PC to the CDD-Live DSP.

'**Export Snapshot**' is used to store CDD-Live settings as a file to your PC. This can be used to archive snapshots to build a library of commonly used settings which can be quickly imported back into a system. This is the Export Snapshot Window; -

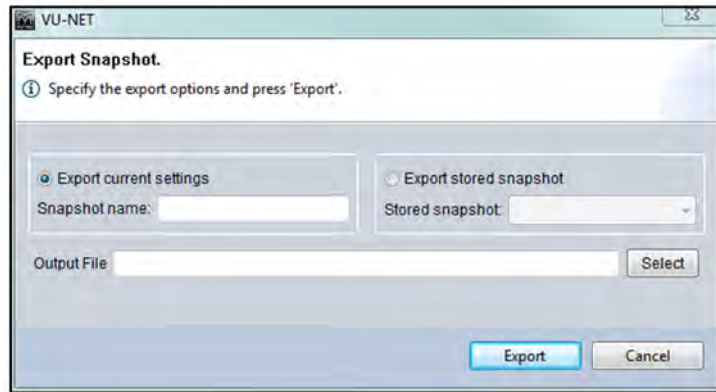

You can choose to select the current active settings, a true snapshot of the system configuration, or to export one of the four Snapshots stored in the cabinet DSP. If you choose to Export the current settings you should first give the Snapshot a name so it is easy to identify when it is imported back into a cabinet "CDD-Live8 Stereophonics" for example.

If you click on 'Export stored snapshot' you next need to select one of the four internal snapshots, either 1 to 3 which are the factory snapshots or 4 which is the user snapshot location.

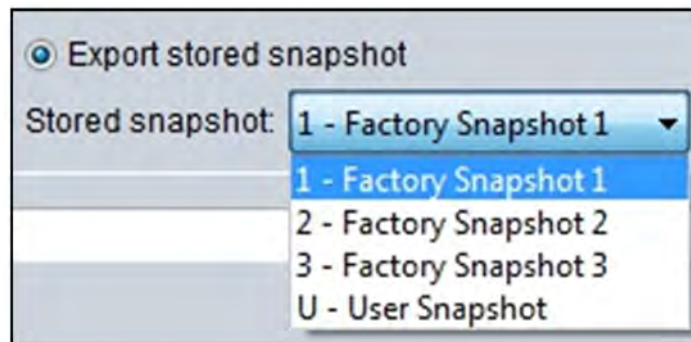

Next click 'Select' to navigate to an appropriate location on your PC to store the file and give it a suitable name.

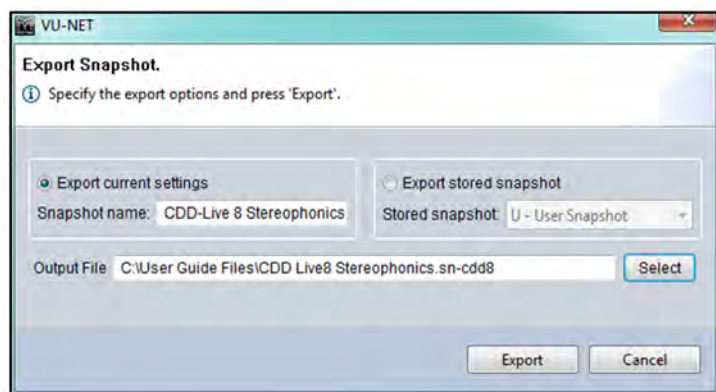

Finally click 'Export' to upload the Snapshot to your PC.

**'Synchronise'** is a manual synchronise that duplicates the automatic synchronise that occurs when CDD Live is discovered to ensure that what is displayed in Vu-Net matches exactly the parameters stored within the cabinet DSP.

**'Disconnect/Reconnect'** allows you to disconnect and individual cabinet which will turn red once disconnected; -



Selecting the same function will reconnect the cabinet and it will revert to the standard appearance.

'IP Settings' allows you to change from the default Dynamic IP to static. Clicking on the option brings up this window; -

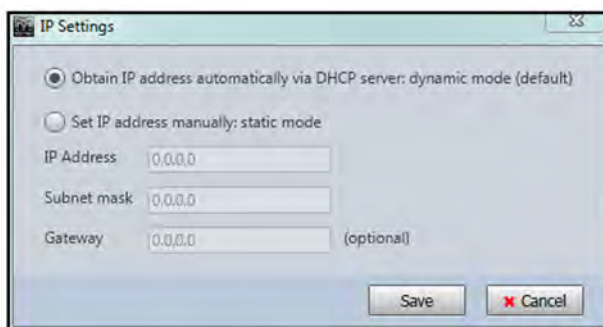

If you select Static IP you will need to enter a manual IP address and subnet mask in the same range as all other devices on the network that you need to communicate with. If you click on 'Set IP address manually: static mode', the IP address, Subnet mask and Gateway windows previously greyed-out will become available; -

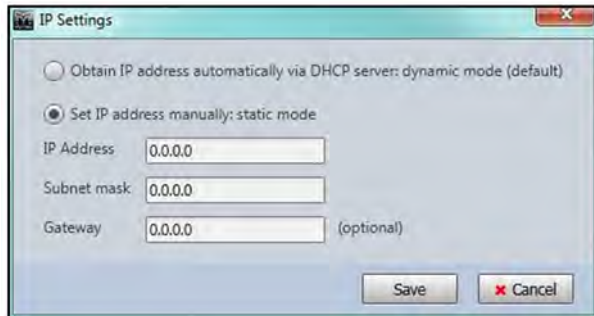

Enter the IP address that you wish to set the CDD-LIVE product to.

Subnet mask is usually set to 255.255.255.0, which means that this CDD-LIVE can communicate with any other product on the same subnet, which has the same IP address in the first three parts xxx.xxx.xxx.

The gateway refers to a device used as a bridge between a LAN and all other IP addresses, usually on a separate LAN which has its own router (hence DHCP server). If communication is required with devices outside of the primary LAN the default gateway needs to be set, usually to the IP address of the second router. For networks with all CDD-LIVE speakers and the PC on the same LAN this can be left at 0.0.0.0.

Click 'Save' and then power-cycle the cabinet, which will set its IP address to the static value entered in the dialogue box shown above.

**Once this is done you will no longer be able to see the CDD-LIVE speaker in Vu-Net because Vu-Net is still running on a network with dynamically assigned IP addresses. You will need to close Vu-Net and set your PC to a static IP address in the same subnet as the CDD-LIVE product before you can connect to the CDD-Live product again.**

'Rename' allows you to give the cabinet a name of your choice up to 30 characters, this can also be accessed by selecting the speaker and using the keyboard shortcut F2; -

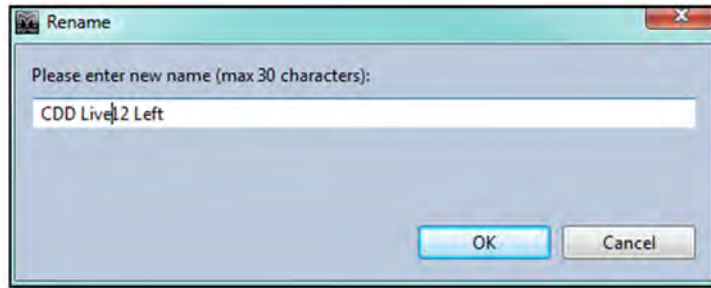

'Select All' selects all devices in the system Diagram, the keyboard shortcut for this is Ctrl + A.

'Delete' removes the selected CDD-Live speaker. You will be prompted with the following Window to confirm the delete; -

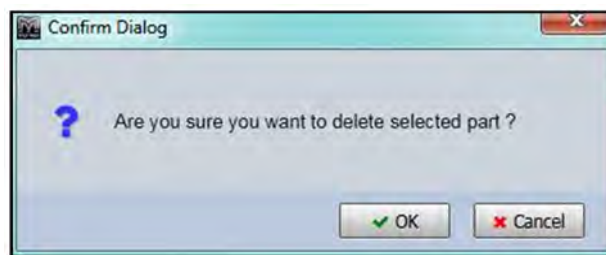

If you selected Delete accidentally or have changed your mind, click 'Cancel', otherwise click 'OK' and the speaker will be removed from the project.

## Overview

Either double clicking or right clicking and selecting Open will bring up the overview option for the CDD Live which shows all CDD Live speakers in the project depending on which selection method you have used, Open, Open Selected or Open selected zones. There is an option in System Preferences to have SXP subs appear in the same window as CDD-Live or a separate qwindow of their own.



This is the SXP Overview:-

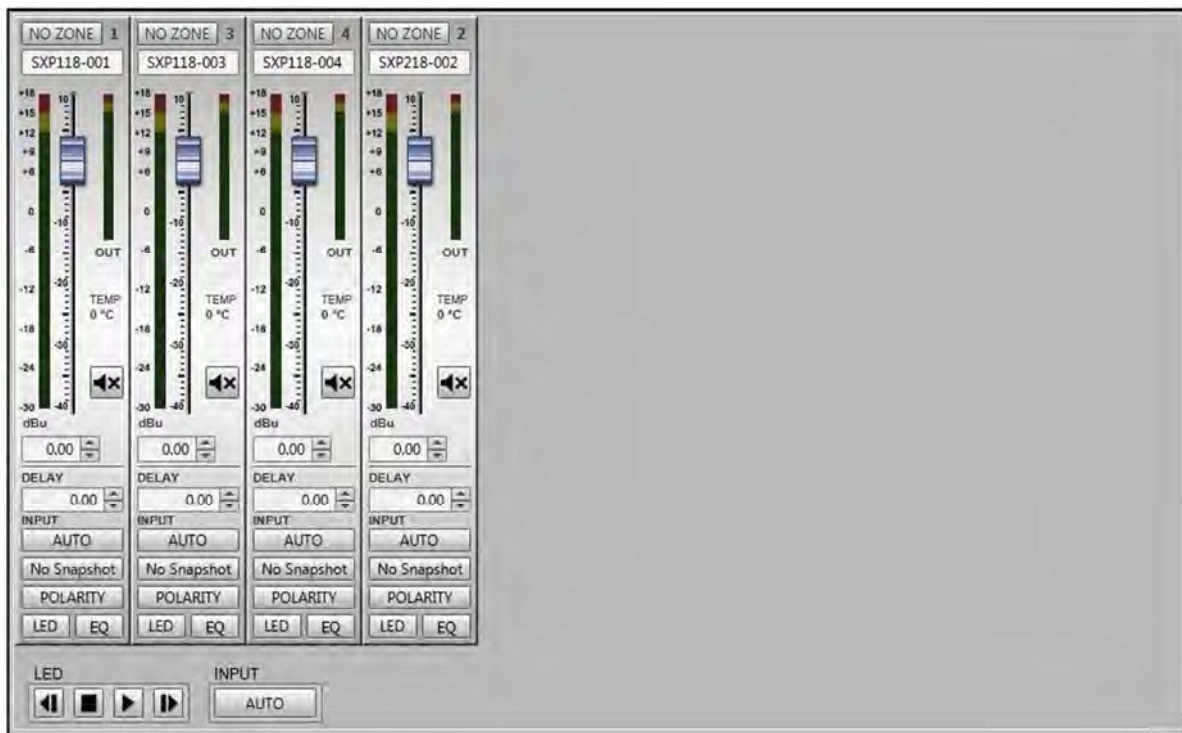

Note that CDD-LIVE speakers will be discovered in a seemingly random order; -

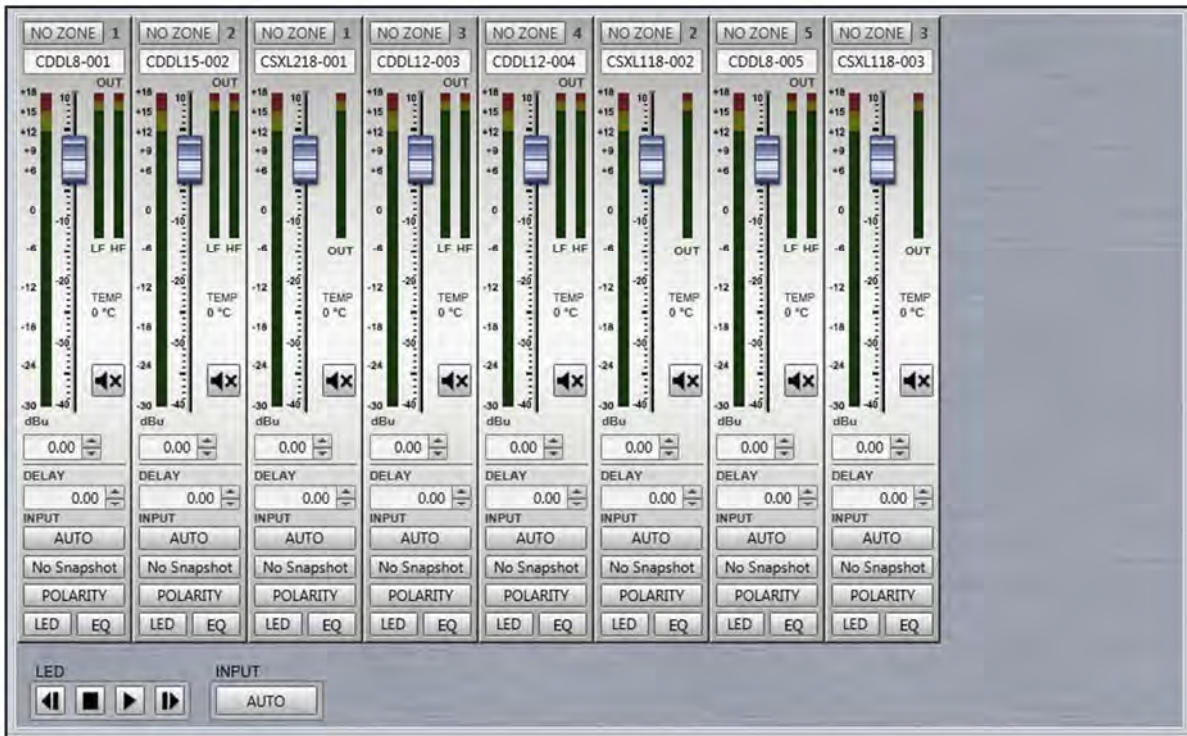

This can be changed in the Project window on the right of the Vu-Net screen. Simply drag and drop the CDD and SXP speakers into the order you would prefer perhaps grouping them by type; -

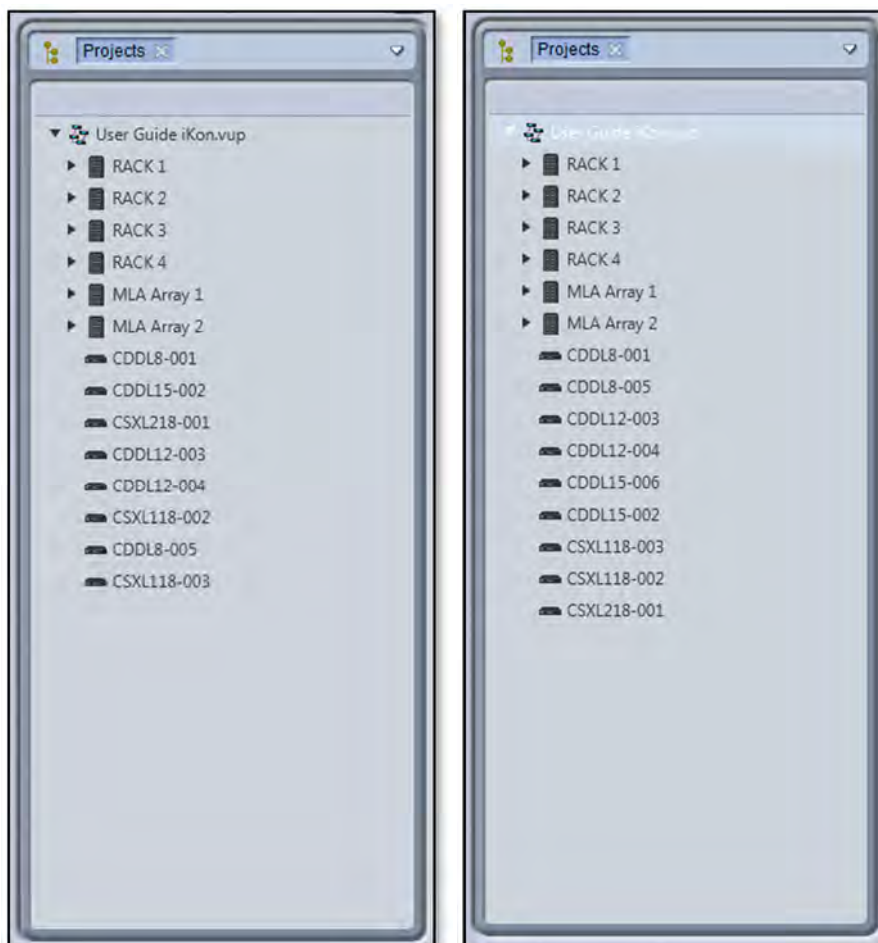



They will now appear in the same order in the Overview window; -

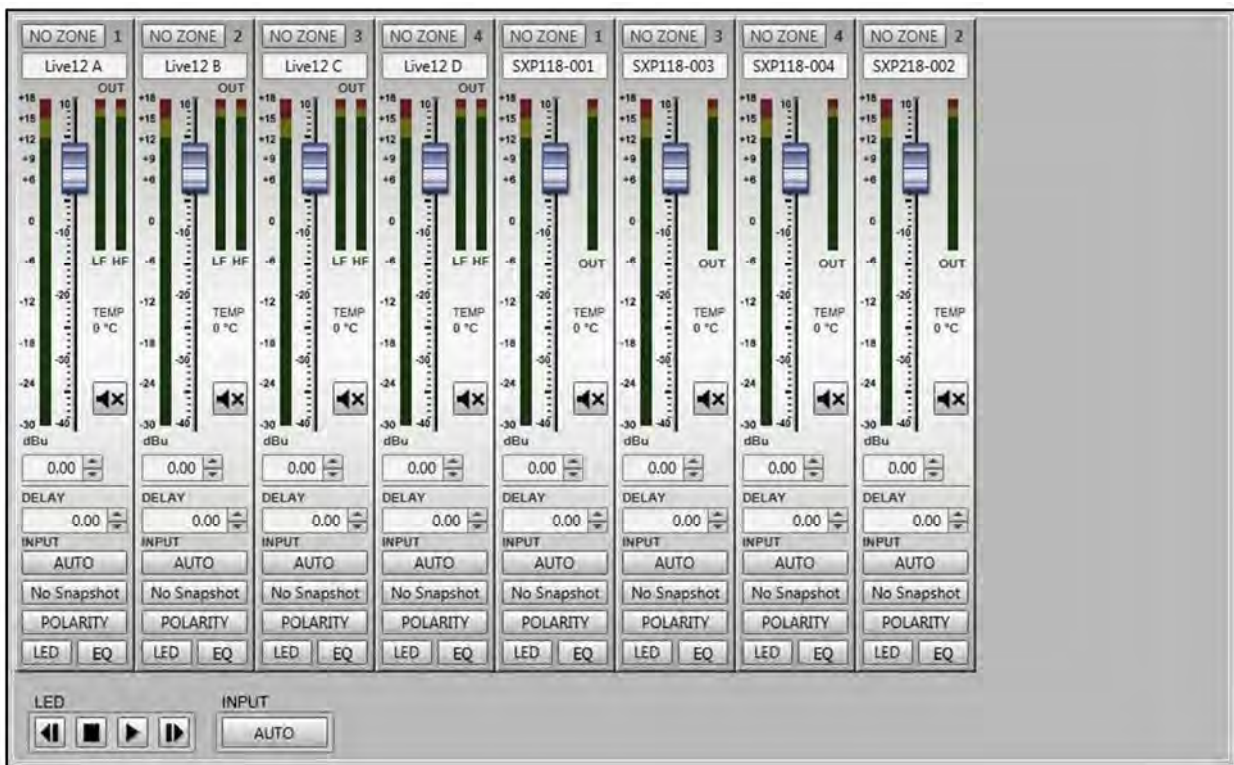

This gives an overview of the state of all CDD and CSX Live speakers allowing comprehensive monitoring of the system.

The box at the top will show any names that have been assigned to the cabinets by right clicking and selecting rename (or selecting and pressing F2 in the System Diagram; -



The gain fader allows gain adjustment from -40 to +15dB. Precise values can be entered by typing directly in the box below the fader or values can be scrolled up or down using the up/down buttons. The increments that the up/down buttons will step is determined in the Preferences section, by default it will be 0.25dB.

The mute button will mute the cabinet irrespective of the position of the gain fader and will turn red when active.

There is comprehensive metering available. The bargraph to the left of the fader shows input level up to the maximum before input clip of +18dBu. The smaller meters to the right show the amplifier output levels for both the low frequency amplifier driving the LF driver and the high frequency amplifier driving the compression driver and show level prior to limit. If the levels reach the yellow segment you have reached the limiter threshold. A red segment indicated 3dB of gain reduction in the limiter.

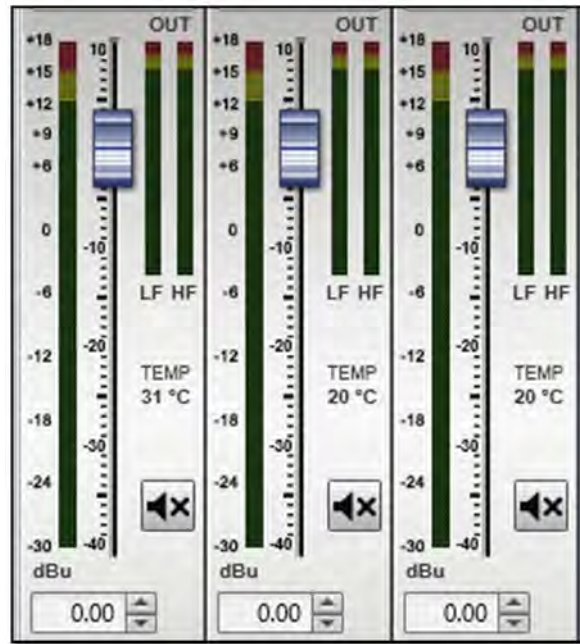

There is also a temperature read out showing the temperature of the DSP and amplifier module; -

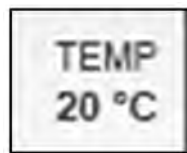

There is delay available which is very useful for time aligning CDD Live when used as an extra fill with a larger mains system. The maximum delay available is 1 second. Values can either be typed directly into the Delay field or scrolled up and down using the arrow buttons. These increase or decrease the delay in increments of 10µs.



The Input allows the connection mode to be changed from the default which is Auto to Analogue or Dante. This can either be done individually for each CDD or CSX Live or globally using the Input switch at the bottom of the overview Window. A global change will bring up the following window; -



Click 'Cancel' if you have changed your mind or 'OK' to accept the change of input mode. All CDD or CSX Live will display the new input selection.



The Snapshot button acts in the same way as the Load and save Snapshot functions available from the right-click menu in the Project System Diagram. Clicking on the Snapshot button brings up the option to Load or Save; -



Selecting 'LOAD Snapshot' will bring up the Snapshot Menu with the currently active Snapshot shown highlighted in green; -



Clicking on a new Snapshot number or letter will prompt you to confirm your selection; -

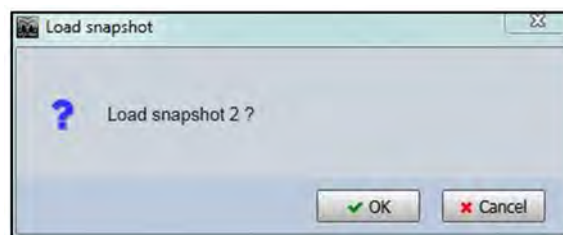

Clicking 'OK' will confirm the selection and the preset will load. The Preset select window can be closed. The currently active Snapshot is displayed on the Snapshot button; -

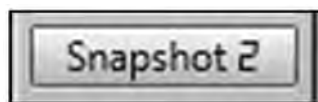

Selecting SAVE Snapshot will bring up the save snapshot window; -

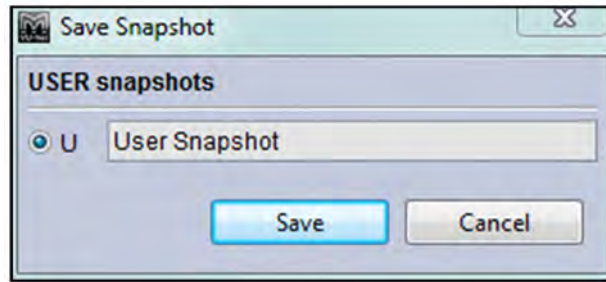

Click 'Save' and the following window appears; -

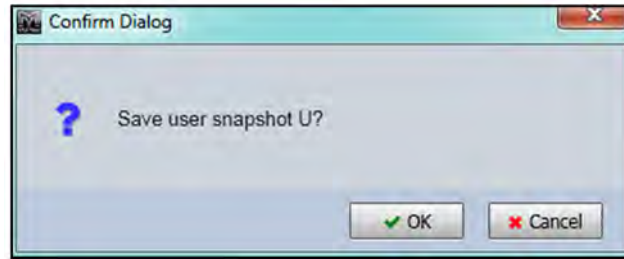

Click 'OK' and your setting are now stored and can be recalled when required.

Polarity will invert the phase of the cabinet. If in Show Mode a confirmation window will appear; -

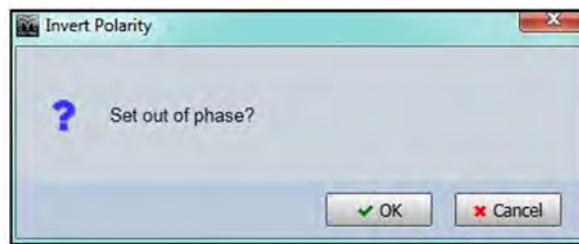

On clicking 'OK' the phase will be inverted and the Polarity button will turn green; -







Clicking the LED button will illuminate the front grille LED to help identify the DD12 under control in multiple deployment applications. This can be done individually for any cabinet; -



Or globally using the LED controls at the bottom of the CDD or CSX Live Overview window; -



Pressing the "play" arrow  will make the LEDs of all CDD Live illuminate in sequence, cycling round continually until you click on the stop button . Note that the global LED switches will overwrite any LEDs which have been activated on an individual

CDD or SXP. The back and forward buttons   allow manual cycling of all cabinet LEDs, each click will extinguish the currently illuminated LED and light the LED on the next or previous CDD or SXP.

## EQ

The EQ button will open the EQ tab for that particular CDD or SXP speaker. The EQ window is virtually identical to all other Vu-Net controlled devices; -



The window has three sections, the buttons along the top, the graphic display window and the controls on the right of the window. First we will look at the buttons along the top.

First there are eight parametric EQ buttons plus the high pass filter; -

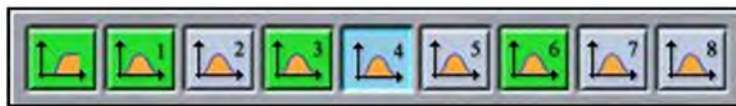

As you can see there are a number of colour variations for these buttons. Unused bands are pale blue until they are selected for editing by clicking on them in which case the colour goes to a brighter blue and the image shows the button depressed. Unused is defined as the gain left at 0dB. Green buttons indicate a band that has either cut or boost applied, these will go a pale green when selected. Note that the high pass filter is always active so will always appear green. The graphic view of the equalisation is a relatively standard frequency response graph; -

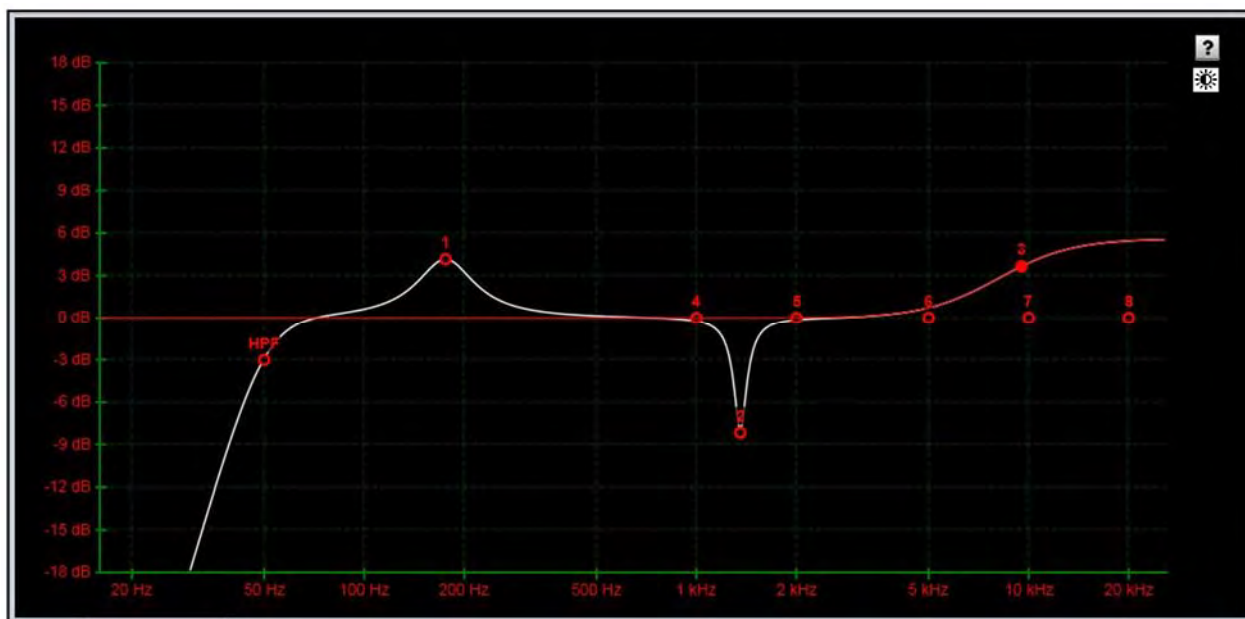

The horizontal axis is frequency in Hertz from 20Hz to 20KHz, the vertical axis is gain from -18dB up to +18dB. Colour coding is also used on the graph to represent the various modes.

First there are two traces, one red, and the other white. The red trace is the response of the band that is currently selected; the white trace is the overall response of the entire PEQ.

Each small red circle represents the position of each of the ten bands plus the high pass. For all of the EQ bands the position on the horizontal represents the EQ centre frequency, the vertical position is the cut or boost applied. A solid red circle is the currently selected band, any greyed-out band indicates that an EQ has been bypassed. The circle labelled "HP" identifies the cut-off frequency of the highpass filter.

In the right corner is this icon; -



This is used to cycle between standard and daylight modes. In daylight mode the display changes to look like this; -

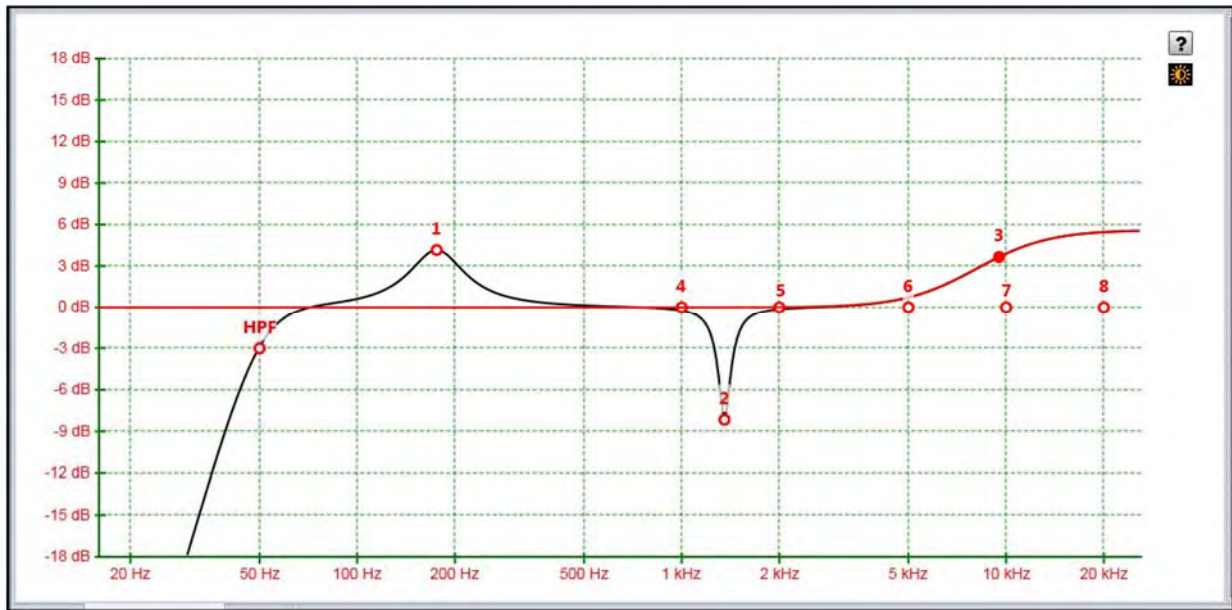

This is intended for use outdoors setting up a festival system where the normal display is difficult to view in bright sunlight. A further click on the icon will return to the default view.

In common with most PC controlled equalisation systems it is possible to make adjustments by dragging and dropping the filter curves. Left-click on any of the band rectangles and holding down the left mouse button, drag the icon horizontally to change the centre frequency or vertically to change the gain. Right-click and drag or Ctrl and drag up and down to adjust the filter Q factor. The graph will adjust and the audio adjustment will be made in real time.

The final section on the right of the window is the Properties panel; -



This shows all properties of the selected band. At the top is a flat button; -



This will zero the gain of the selected filter.

Next is a Filter type. Click on this and the drop down shows the options for each filter band; -

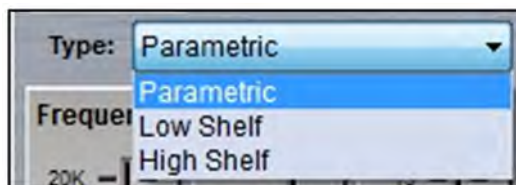

The default is Parametric, the other options are Low and High Shelf filters.

The High Pass Filter has the following options for filter type and slope; -

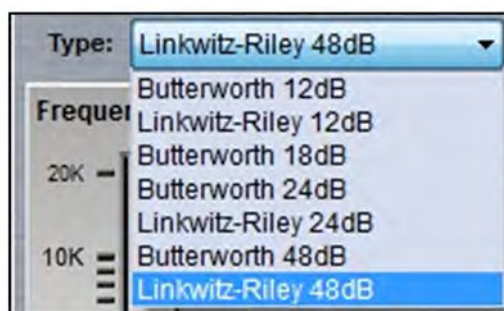

Below are the three principal faders for adjusting the filter parameters; -



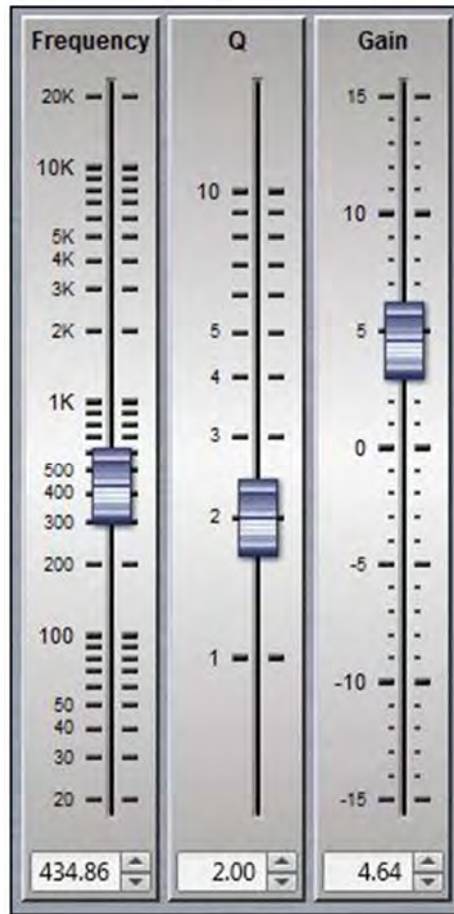

Parameters can be changed on the properties panel in three ways. The faders can be drag and dropped to a new value, the value can be scrolled up or down using the up/down buttons to the right of the value windows, and finally values can be directly typed into the value windows. The response graph will adjust according to the new values and vice versa, adjustments in the graph window will be reflected in the fader positions and values in the properties panel.

To summarise, there are four ways to adjust filter parameters; -

1. Click and drag on the graph
2. Click and drag the properties faders
3. Use the up/down value buttons in the properties section
4. Directly type values into the value boxes.

Whilst this might seem over-versatility, it is intended to offer several options to suit the way that the system is being operated. If adjustments are being made with using a wireless tablet PC with a stylus whilst walking around a venue, certain options may be easier to use than if you were sitting at a desk with a mouse plugged in to the PC.

## Zones

Any cabinet can be a member of any (or none) of the twenty zones available which are labelled A to T which will gang together all parameters for every cabinet in the zone. Note that all gain and delay parameters are *offset* ganged. If there is already a value entered before adding a CDD Live cabinet to a zone this will be retained and subsequent changes to a value for any gain or delay to any cabinet in the same zone will increase or decrease all values according to any edits you make but will retain the relative difference between all values. To select a zone click on the Zone button at the top of the Overview page; -

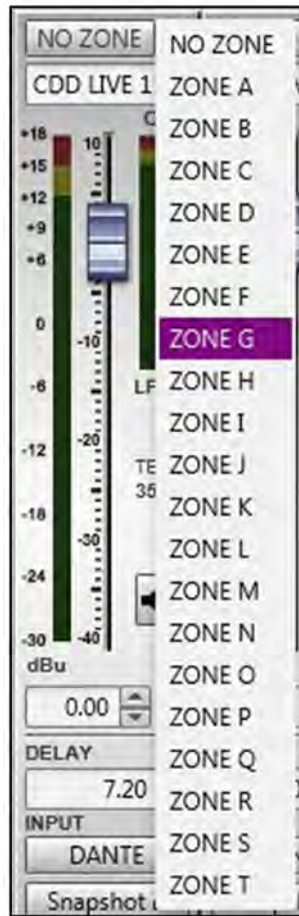

Click on the desired zone and it will be displayed on the zone button. The zones are colour coded to make it instantly obvious which cabinets are on the same zones. Colours are as follows; -

A is Blue	K is Lavender
B is Red	L is Brown
C is Green	M is Turquoise
D is Yellow	N is Dark Brown
E is Black	O is Flesh
F is Teal	P is Light Green
G is Deep Purple	Q is Violet
H is Moss Green	R is Sand
I is Pink	S is Crimson
J is Dull Green	T is Azure

All functions on cabinets in the same zone will be duplicated regardless of which cabinet in the zone is used to make adjustments. Note that all gain and delay parameters are *offset ganged*. If there is already a value entered before adding a CDD Live to a zone this will be retained and subsequent changes to gain or delay to any cabinet in the same zone will increase or decrease all values according to any edits you make but will retain the offset between all values; -

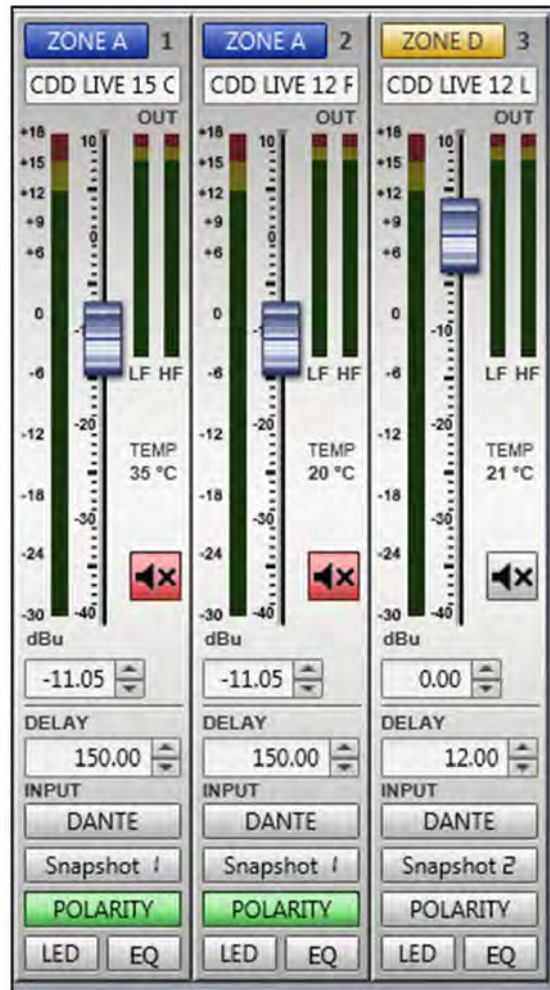

## Ganging

In addition to zoning which gangs all parameters, the ganging function can be used to gang all functions, groups of parameters such as inputs or outputs, or even individual parameters. The ganging window is opened using the button on the toolbar; -



The window will appear as follows; -

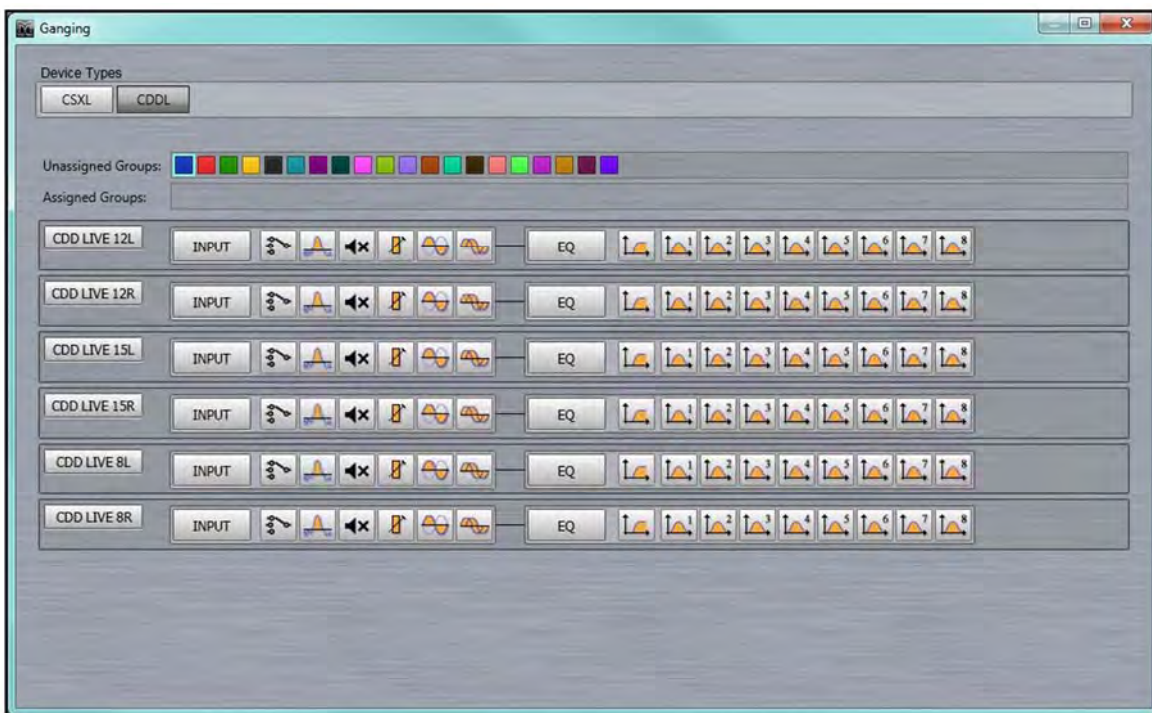

A gang is created by clicking on one of the unassigned groups (or an assigned group if you wish to add more parameters to an existing gang) and clicking on the functions that you wish to group. If you click on the cabinet name all parameters will be ganged which is exactly the same as adding the cabinet to a zone from the main CDD LIVE Window. You can gang all input functions by clicking on **Input**, all output parameters by clicking on **Sub EQ** or **Main EQ**. Individual parameters can be ganged by clicking on the parameter icon. You can also remove individual parameters from a gang by clicking after it has been ganged. For example, if all parameters have been ganged as would be the case if a cabinet has been assigned to a zone, you can click on say the mute icon for both outputs so all parameters such as the gain, delay and EQ will track but with individual mute available for all outputs. Here are two CDD-LIVE8 assigned to zone A but with both output Mutes *un-ganged*; -



Here is a more complex example with both CDD-LIVE12s ganged with Mute un-ganged. The CDD-LIVE15s have their inputs ganged minus the mute but with just the high pass filter on the outputs ganged. The CDD-LIVE8s have their entire outputs ganged and their delay ganged. All six have their input source ganged together; -

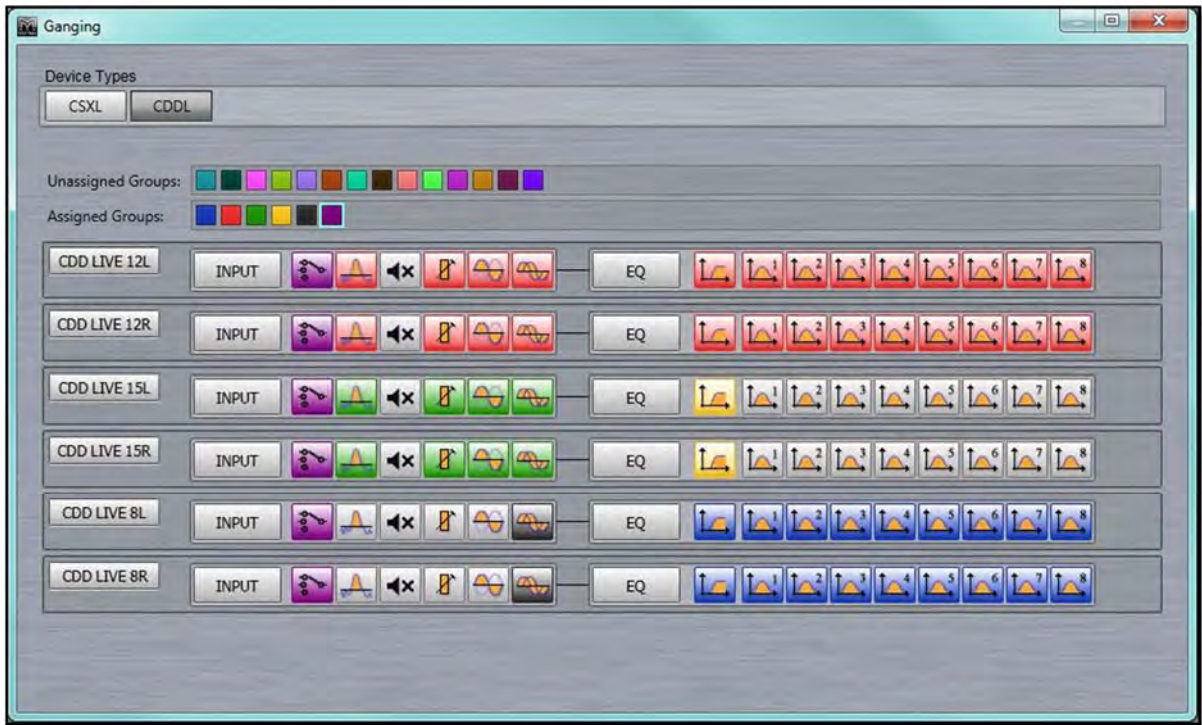

Note than when a cabinet has a gang assigned that is anything other than a full gang of all functions, the zone button will change from displaying the zone letter and colour to "User Defined"; -



## Merlin

The Merlin system controller is most often employed in MLA systems as a PC to U-Net interface however the Merlin is a four input, ten output audio processor with a host of extremely powerful functions available, all of which can be controlled via Vu-Net on exactly the same platform as MLA, MLA Compact, MLA Mini and other U-Net compatible systems. As well as being used as a simple matrix for controlling main arrays, side hangs and subs, it could easily be deployed to control conventional non-powered speaker products in use at events as stage front fills for example. The fact that everything can be controlled on the same tablet PC running Vu-Net makes system alignment and trim very straightforward indeed.

### Gain, Mute & Limiters

Double clicking on the Merlin in the System overview page opens the Merlin System Control window which by default opens on the first Gain/Mute/Limiter tab; -



This has all input and output channel faders, meters and mute buttons available. As with the gain control on other Vu-Net controlled devices there is up to +15dB of gain or -40dB of cut available on all inputs and outputs. Metering is different for input and output. Input shows absolute input level in dBu, the upper point is +22dBu which is the highest level signal which can be applied to the input prior to clipping. The output meters display level before limit therefore their range will be determined by the limiter threshold that has been set for that particular output. The metering shows green up until it reaches 3dB from the limiter threshold whereupon it shows amber and finally red when the limiter threshold is reached. The upper most point of the meter shows 3dB of gain reduction- essentially 3dB over the limit threshold.

Limiters are accessed by clicking on the 'SHOW LIMITERS' button; -



This brings the output limiter controls up at the bottom of the window; -



By default the time constants are set to Manual but they can be set to Automatic by clicking the Auto Time Constant button which will then grey out the Attack and Release windows. Auto Time constants select the most appropriate time constants for the frequency band that has been selected using the high and low pass filters in the PEQ window for each output. Parameters are set by clicking on the drop-down arrow and selecting the desired value from the list; -

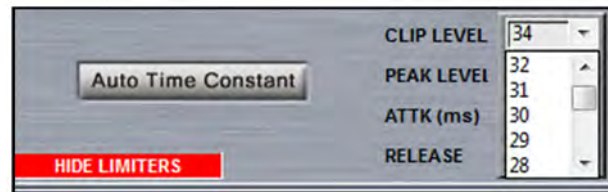

Clip level is a clip limiter designed to catch very fast peaks that might exceed the input headroom and can be set from +2dBu to +34dBu in 1dB increments.

Peak Level is the principal limiter threshold with time constants determined by the Attack and Release controls. The threshold range is from -10dBu to +22dBu also in 1dB increments.

Attack time is in milliseconds and can be the following values; 0.3, 0.4, 0.5, 0.7, 1.0, 1.4, 2.0, 2.8, 4.0, 5.7, 8.0, 11, 16, 23, 45 or 45ms

Release is specified as a multiple of the selected attack time and can be either 2x, 4x, 8x, 16x, 32x or 64x.

The limiter can be hidden again by clicking the 'HIDE LIMITER' button.

## Routing

The Routing Tab brings up the routing matrix window which allows the input and output modes to be selected and the routing freely configured; -

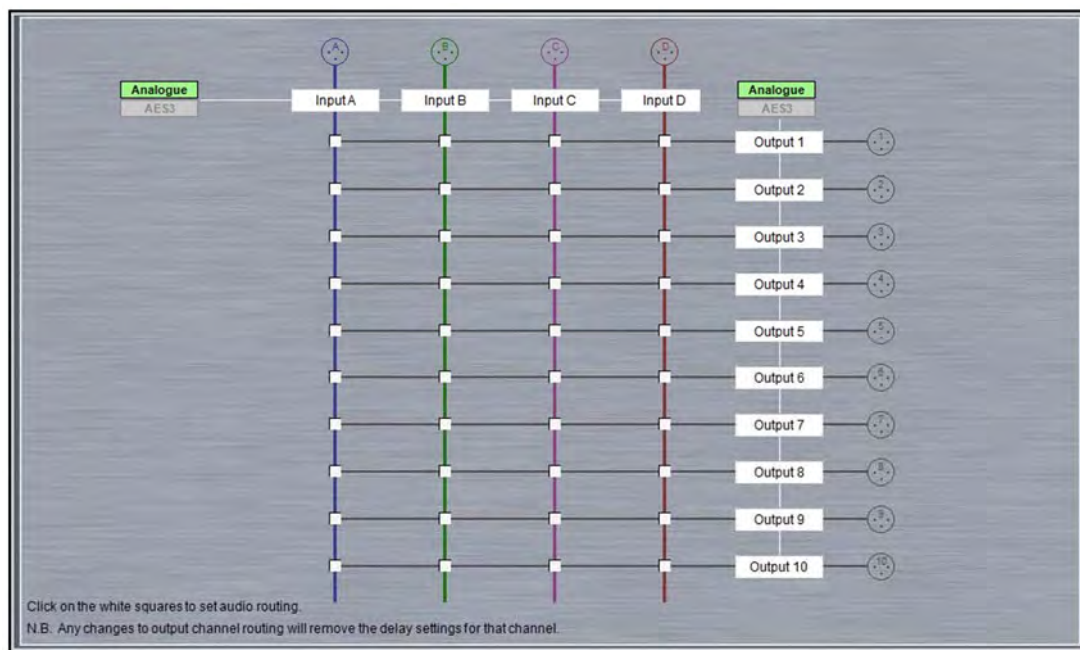

The routing page is also used to label inputs and outputs, simply type the required name in the appropriate box. The name can be up to 12 characters and will appear in all other Merlin tabs within Vu-Net and on the unit itself but as there is limited space on some windows, the Gain/Mute/Limiters page for example, we would recommend keeping name as short and succinct as possible.

You may also select input or output routing to be AES3 or analogue by clicking on the boxes for all input and all outputs. Note that it is possible to change inputs and outputs independently; -



Note that selecting AES for either inputs or outputs changes how physical connections are made to the Merlin rear panel connectors. This is duplicated on the routing page to help make it clear exactly how the Merlin needs to be patched, see the chapter on the Merlin for more details. This for example is how the routing looks for a system with analogue inputs and AES3 outputs.

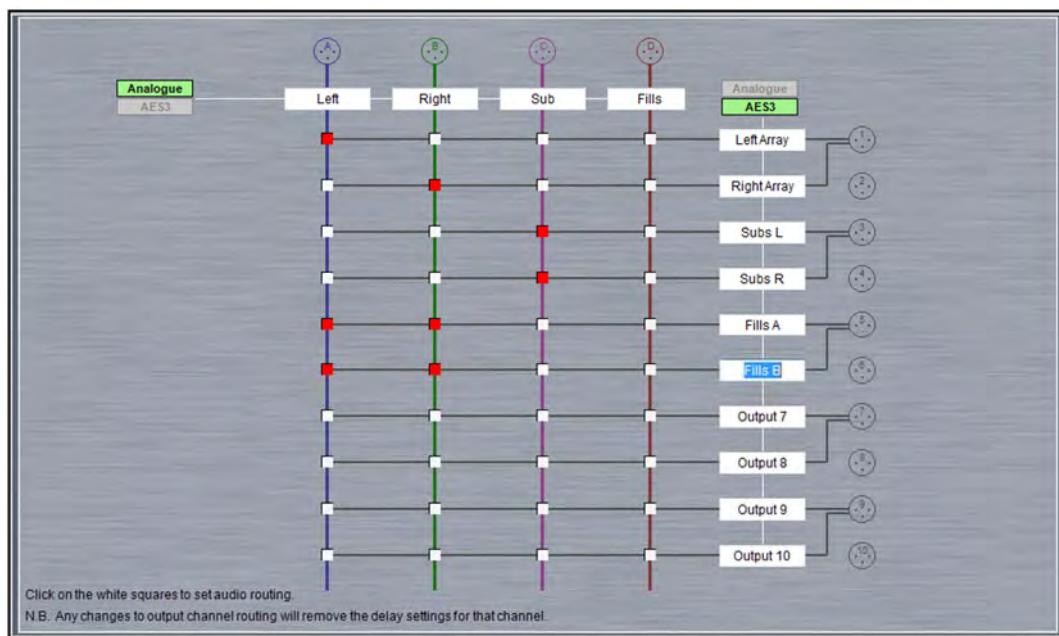

The routing matrix is shown with the inputs forming vertical columns and the outputs as horizontal lines. Each node can be selected to route any input to any or all output. This is entirely freely configurable, there are no restrictions on where or how many outputs and of the inputs are routed to. Note that any changes to the routing will remove any delay settings that have been configured for any of the output channels. Here is a routed and labelled system; -



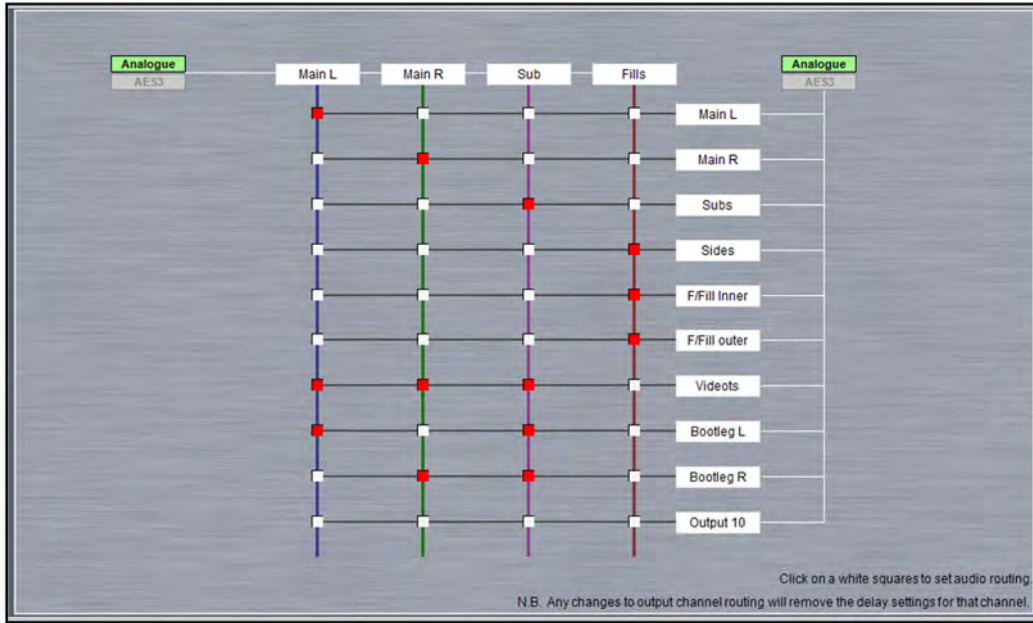

### Input Channels

The input and Output channel tabs are very similar to the PEQ window for MLA, MLD and MLA Compact with a few notable differences; -



As with other Vu-Net EQ windows, the daylight icon is available; -



This is used to cycle between standard and daylight modes. In daylight mode the display changes to look like this; -



This is intended for use outdoors setting up a festival system where the normal display is difficult to view in bright sunlight. A further click on the icon will return to the default view.

In common with most PC controlled equalisation systems it is possible to make adjustments by dragging and dropping the filter curves. Left-click on any of the band rectangles and holding down the left mouse button, drag the icon horizontally to change the centre frequency or vertically to change the gain. Right-click and drag or Ctrl and drag up and down to adjust the filter Q factor. The graph will adjust and the audio adjustment will be made in real time.

The input that is being controlled is selected by clicking on one of the four buttons labelled A-D; -



Each input has eight filters which can be selected from the buttons along the top. Also available are a delay and gain button which are "short cuts" to the delay and Gain/Mute/Limiter windows.



Filters may be manipulated in exactly the same way as the PEQ filters in the cabinets. The filter can be grabbed and drag and dropped to select the desired frequency and gain, using right click to modify Q factor.

The parameter section allows precise values to be typed into the value windows, the faders drag and dropped or values cycled up or down using the appropriate arrows. There are additional options for the filter type selected by the 'Type' drop down; -

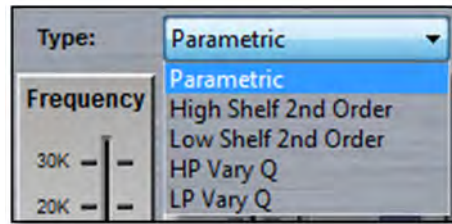

High Shelf 2<sup>nd</sup> order is a high shelf filter with gain available from -15dB to +15dB and Q from 0.25 up to 1.0; -

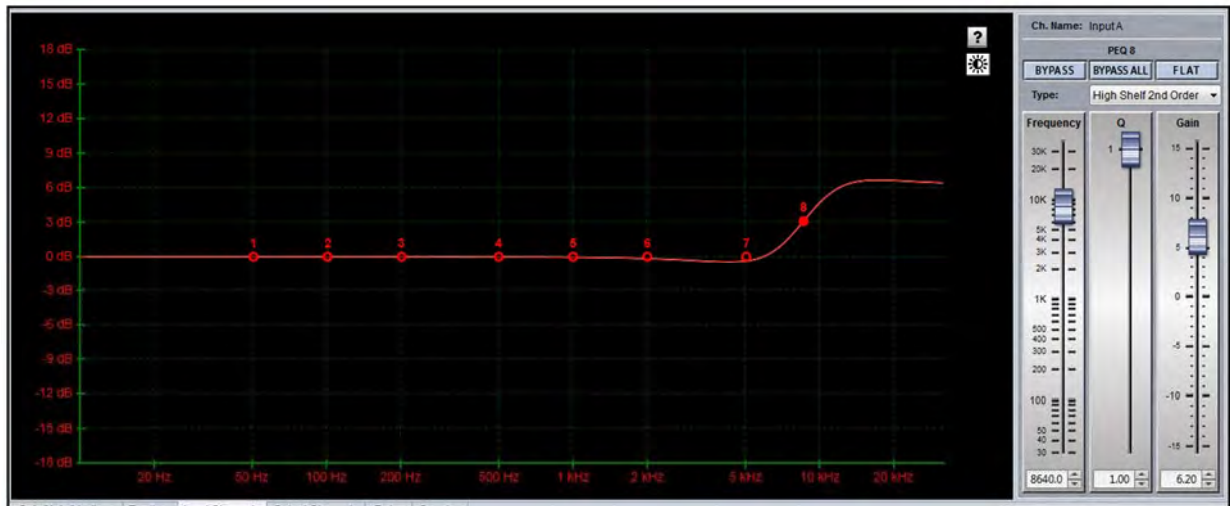

Low Shelf 2<sup>nd</sup> Order is a low shelving filter also with +/-15dB of gain and Q factor from 0.25 to 1.0; -



There are no dedicated high and low pass filters on the inputs but High pass and lowpass with variable Q are options for filter types; -

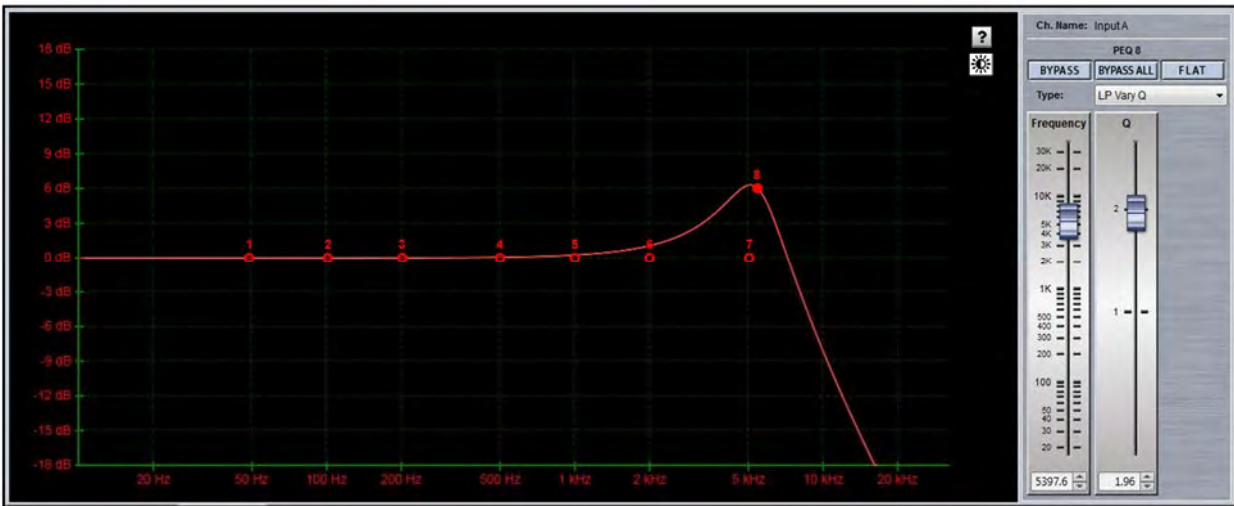
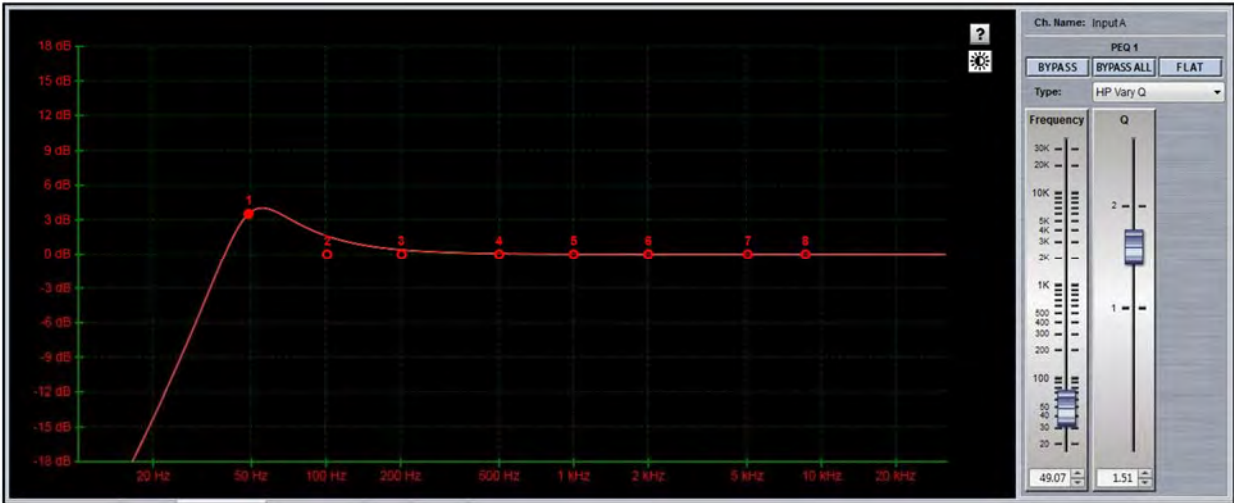

You can also select 'Show All' to display all four input channels overlaid with different colours for each; -

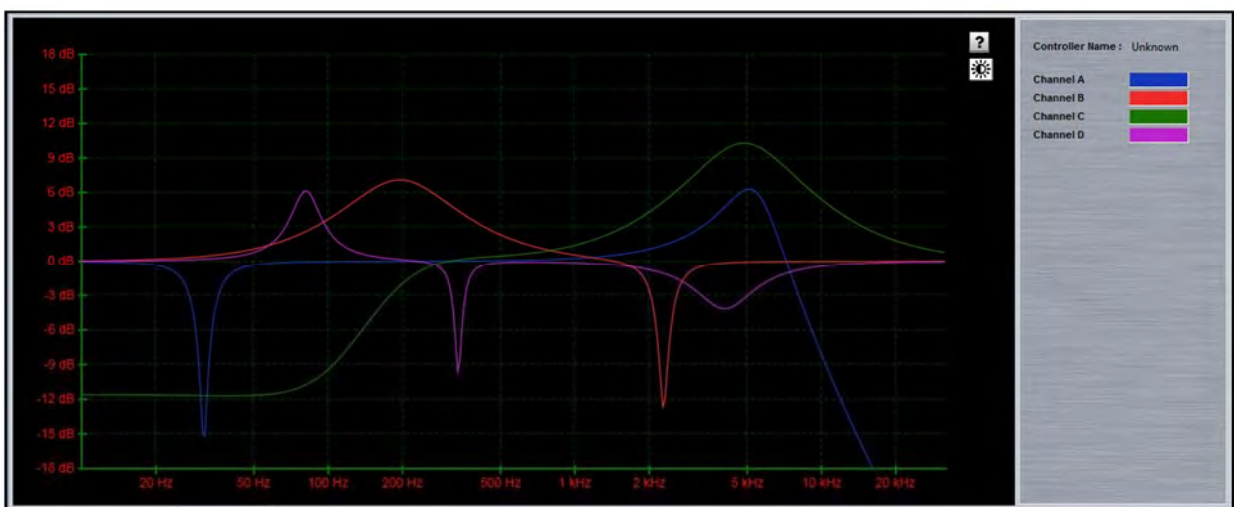

As well as eight bands of equalisation there are buttons for delay and gain; -



These are a shortcut directly to the tabs for those functions.

The name allocated to each input is displayed above the EQ parameter controls on the top right of the window; -

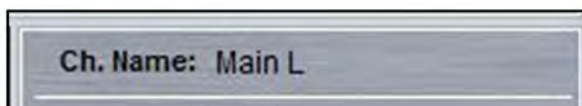

### Output Channels

The output channel page is almost identical to the input pages; -



There are naturally a few differences, the output channel being viewed is selected by the 10 buttons at the top of the window; -



There are also eight filters available selected by the buttons top left but in addition there are also dedicated high and low pass filters; -



The last three buttons are short cuts to the delay, gain and limiter sections.

The parametric EQ have the same options as the input channels, parametric, high and low pass 2<sup>nd</sup> order shelving EQ and high and low pass filters with variable Q; -

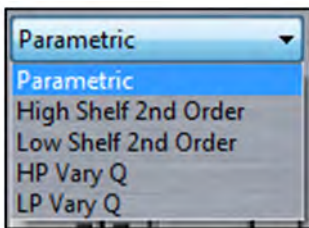

The High and lowpass filters can be configured as either Bessel, Butterworth or Linkwitz Riley types with slopes of either 12, 18, 24 or 48dB per octave (48dB/oct is only available on Butterworth or Linkwitz Riley); -

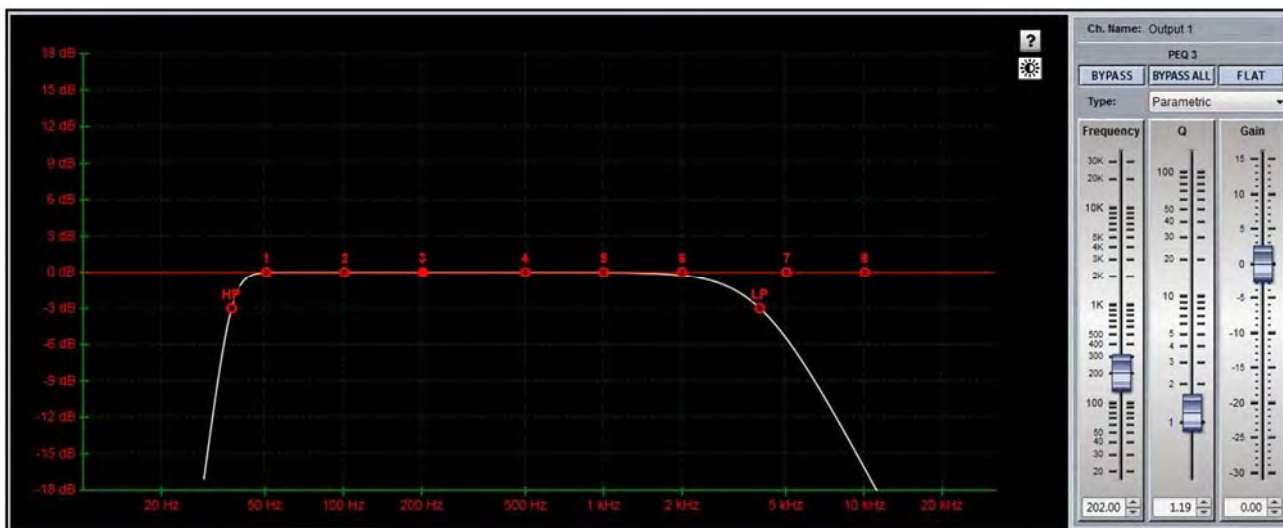
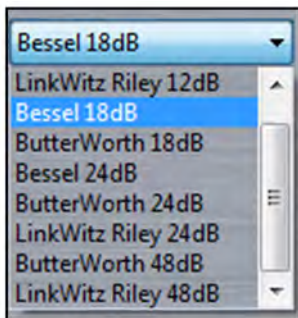

As with the input channels, the output channel name is shown above the EQ controls; -

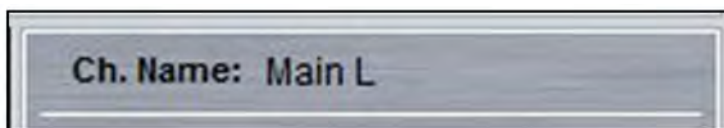

### Delay

The delay window offers a sophisticated system for controlling time alignment if all systems routed via the Merlin. The maximum through delay from input to output is 1 second so for example you can add 999.99ms to an output but then you will not be able to add any delay to the input and vice versa, or you could have up to 500ms on the input and the same on the output.

It is important to note that if you make any changes to routing after you have set delays, all delays on a re-routed channel will be reset to zero.

This is how the routing window appears; -

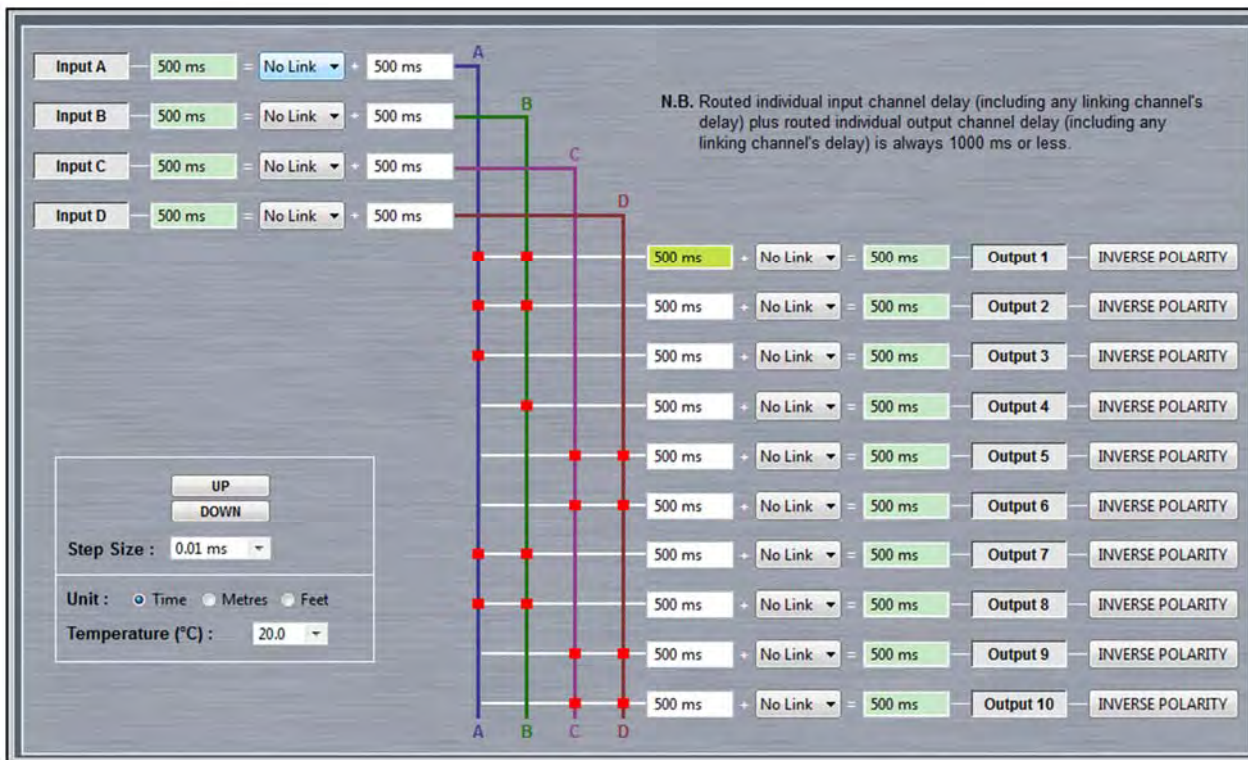

Delay times can be specified by time in milliseconds, or distance in either Metres or Feet. This is set in the bottom left of the window; -

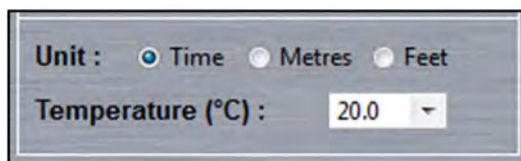

The temperature can be set to match the ambient temperature at the venue and will compensate for the variations in speed of sound through the air as temperature varies when distance has been selected. The temperature adjustment does not affect delay times when Time has been selected as the unit of display. The temperature is selected from a drop-down list from -20 to +40°C. You may wish to consider cancelling any shows where the ambient temperature is -20°C; ticket sales are likely to be poor...

The other option available is the step size selected from the box just above the units selection; -

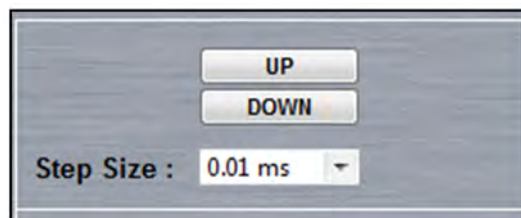

As well as entering an absolute value, any selected delay may be stepped up or down using the 'UP' or 'DOWN' buttons. This is particularly useful when time aligning systems by ear, perhaps using an audible click, the delay can be gradually adjusted until the clicks are perfectly in sync. Step size can be selected from the drop-down and can be 0.01, 0.1, 1.0, 10.0 or 100.0 milliseconds.

The delay window displays the entire routing matrix and input and output channel names so it is easy to see where delays need to be applied. The input and output sections are broadly similar, first here is an input channel; -

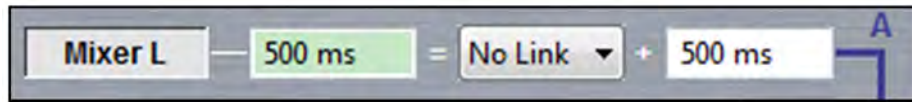

This is Input A as shown by the designation to the right. It has been re-named in the Input Channel tab as “Mixer L”. The first box with a pale green fill is for display only and shows the total delay applied to that input. The total comprises the delay added by virtue of a link to another channel (which will be explained in a later chapter) added to the delay in the final box which is where the required delay for the channel is entered. To enter a delay the input (or output) needs to be selected with a single click whereupon the box fill will change from white to a brighter lime green; -

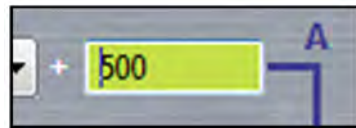

The existing value can then be selected and over-written with the new value following which it can be scrolled up and down if required using the ‘UP’ and ‘DOWN’ buttons. Note that only one delay can be selected at any time but multiple delays can be changed simultaneously by using the link function as we will see.

The output channels are very similar; -

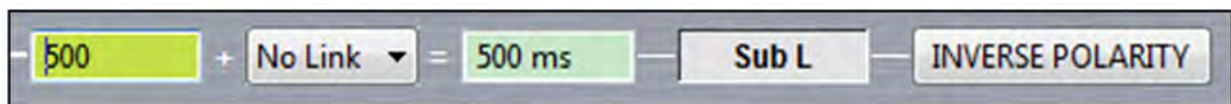

The order of the boxes is reversed. The first box is the active box in which the delay for the output is entered. Next comes the link drop-down. Then the delay display box shows the total delay allocated to that particular output. The output channel name is next and finally a phase button to invert the polarity of the output. The button changes colour to green when Inverse Polarity has been selected; -



## Delay Link

As the name suggests, the delay for multiple inputs or outputs can be linked together to allow simple set up without having to enter the same figures several times. Input link and output link work in the same way but you cannot link an input to an output or vice versa. In its simplest format, you can link several inputs or outputs together. Inputs for example can be linked to any of the other three, in this example, the drop down for input A shows it can be linked to input B, C or D; -

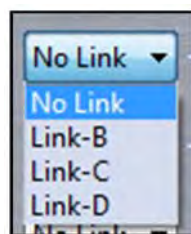

Similarly, Outputs can be linked to any of their other neighbours; here is the link drop-down for output 1



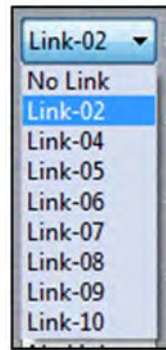

Note that if you link a particular input to another, the “master” input cannot be linked to another channel. This also applies to outputs.

In its simplest use, you can link one or more inputs or outputs to one other and use that to simultaneously change the delay of all linked channels. Here inputs A, B & C have been linked to input D and a delay of 15ms has been applied to input D; -

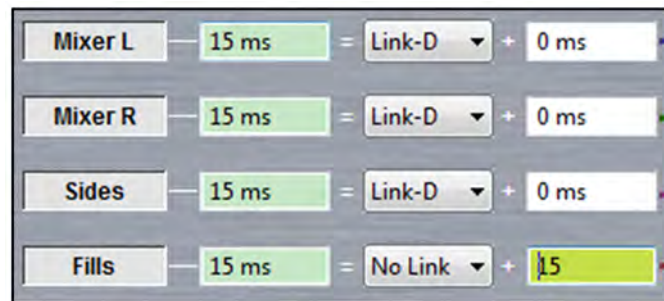

As you can see, although the individual channels A, B & C have nothing entered, the delay display shows 15ms for all inputs.

In addition to this simple matched delay, channels linked to others can also have a delay entered and the total delay will equal the delay entered for the “master” channel plus whatever delay is entered for that channel. Any changes to the “master” delay will be tracked by any channels linked to it. In this example, Output channels 2, 3 & 4 are linked to output 1. Output two has its own delay of 10ms, output three 20ms and output four 30ms. We add 10ms to output 1 and see the following; -

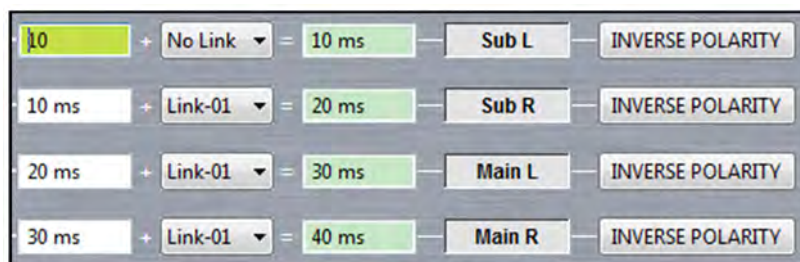

If we now increase the delay on Output one to 20ms we see this; -

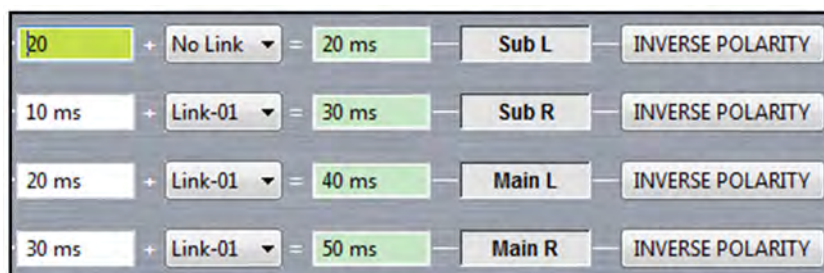

The delay on Output one will always match what is entered, the other three outputs will always match output one plus their individual delay. Linking works in identical fashion to output channels.

## Ganging

The Merlin has an extremely comprehensive ganging capability accessed from the Ganging window which is opened by clicking on the Ganging button on the toolbar; -



This operates in exactly the same way as ganging between the same speaker models and allows ganging of an entire Merlin, individual inputs, individual outputs or even individual parameters. The Ganging window appears like this;

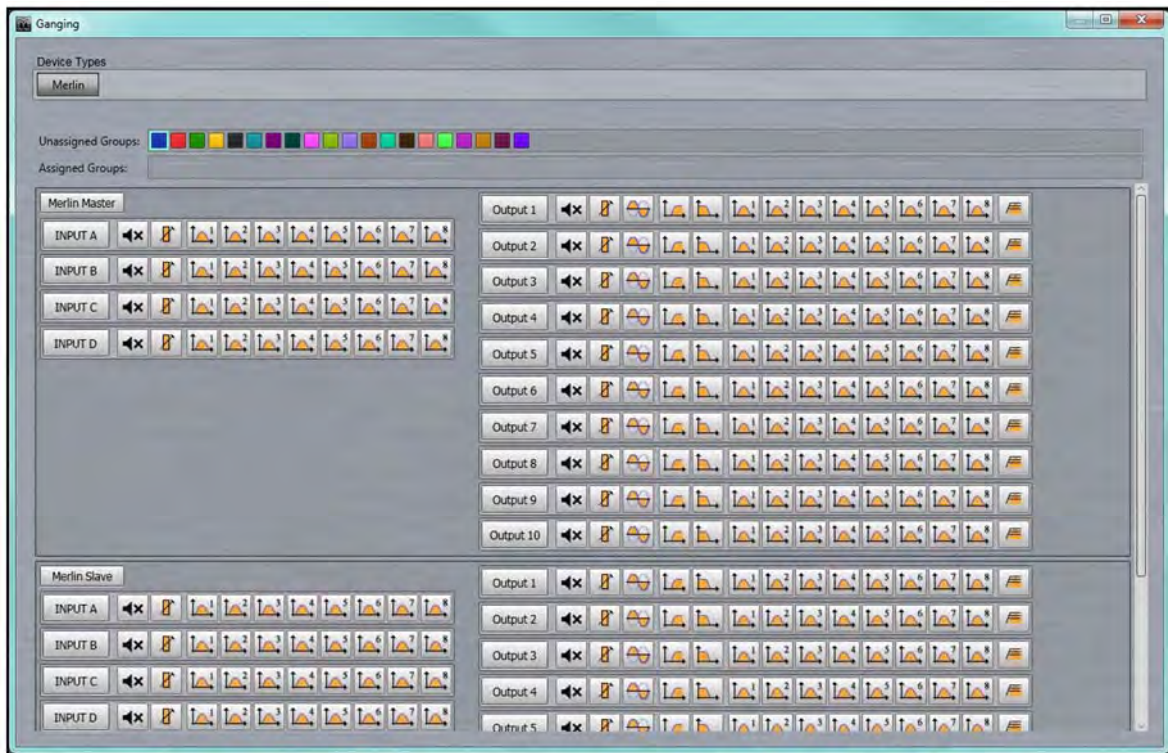

All Merlins in the project will be available, our Master Merlin is shown at the top with our Slave Merlin below, and the parameters not visible can be accessed by scrolling down.

Note that all gain and delay parameters are *offset* ganged. If there is already a value entered before ganging is implemented this will be retained and subsequent changes to a value to any ganged gain or delay will increase or decrease all values according to any edits you make but will retain the offset between all values.

## Ganging entire Merlins

By first selecting an unassigned group (or an assigned group if we want to add more devices to an already created ganging group) and then clicking on the Merlin name buttons we can gang all Merlin parameters. Alternatively we can use the double arrow which appears when we hover over the button for a second. This gives us the option of ganging all Merlins in the project selected with the window that appears;



Select as many Merlins as you need to gang and click again on the first Merlin name button. This shows all Merlins ganged; -



As you can see, Input A on both Master and Slave Merlins are assigned to the blue group, Inputs B to the red group and so on. Note that although the Outputs have the same colour for their ganging groups they are NOT ganged to the inputs. You cannot gang parameters that have different functions.

### Input and output Ganging

You can gang all input channel parameters on one or more Merlin by using the Input and Output buttons. Click on an unassigned group and click on any input button you need to gang, either on one Merlin or several. Click on another unassigned group and repeat for any outputs, choosing a new unassigned group for each new gang. This example shows all input parameters ganged and outputs of each Merlin ganged in pairs as they are routing to stereo pairs; -



### Individual parameter ganging

You can use exactly the same process to gang individual parameters which could be in the same Merlin or across several. As with output ganging, select unassigned Groups first then click on all parameters that you need to gang. The parameters are fairly obvious by their icons, the input channels have mute, gain and eight bands of EQ, output channels have mute, gain, polarity, high and low pass filter, eight bands of parametric EQ and limiters. If you are not sure what any icon is for just hover the cursor over the button and its label appears; -



Here we see a number of individual parameters ganged across a couple of Merlins; -

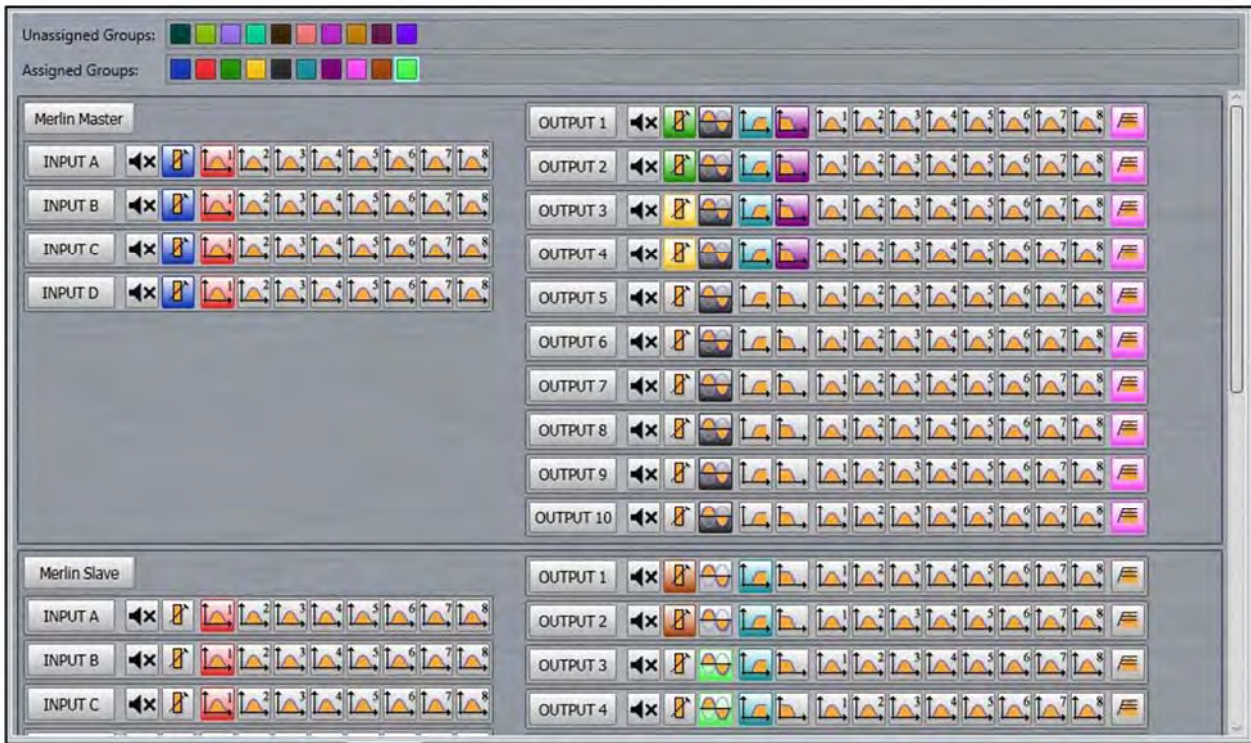

## Turning Ganging Off

To clear a gang just click again on the button you have just used, the gang controls toggle between ganged and un-ganged with each subsequent click. You can clear all ganging from a Merlin by clicking on its name button.

Un-ganging with a single click makes it very easy to create practical ganged systems. For example, perhaps we want all Merlins ganged with the exception of the mute controls so these can be changed independently to make set-up easier. Simply gang all Merlins by clicking on the name buttons, then click on all Mute icons to remove these from the ganging; -



## U-Hub

The U-Hub is a simple Ethernet to U-Hub interface. It has some additional connectivity features to simplify wiring to arrays by utilising unused cores in the network cables. It has no additional processing so has a relatively limited set of options within Vu-Net.

In normal use it would be used in conjunction with an MLA, MLA compact, MLX or DSX system in place of a Merlin. Device Discovery will identify the U-Hub in the same way as it would with a system connected via a Merlin. Synchronisation to the system will appear as follows;

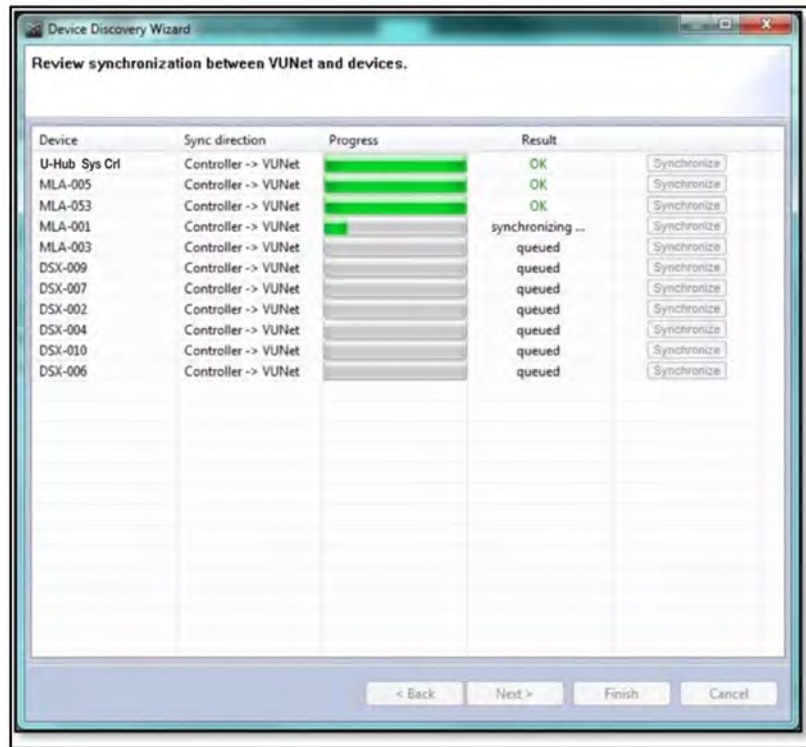

A system utilising the U-Hub will appear like this in the System Diagram; -

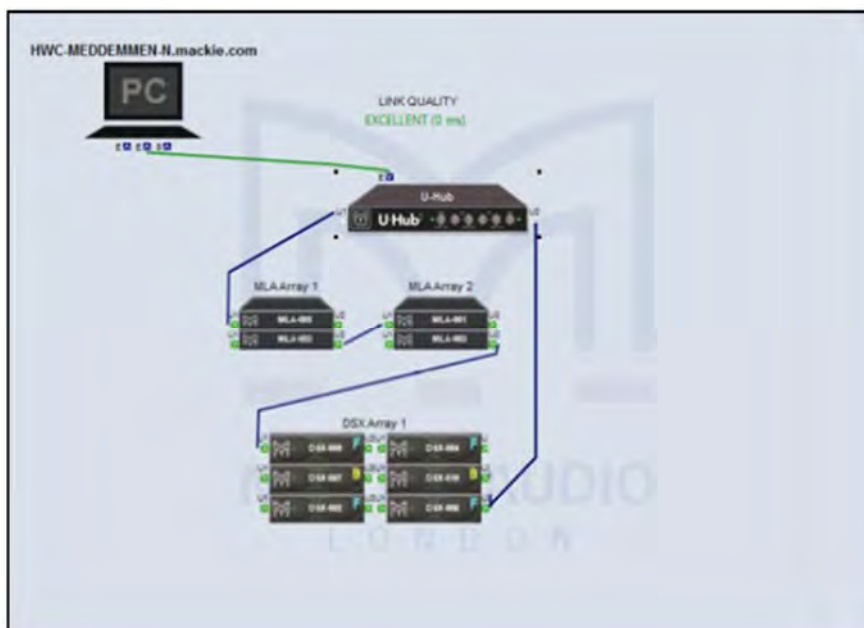

## Device ID

In larger systems with multiple U-Hubs it is helpful to identify them individually so they can be given an appropriate name. Double clicking on the U-Hub icon will illuminate all front panel LEDs on the processor and will turn the front panel name green in Vu-Net as shown; -

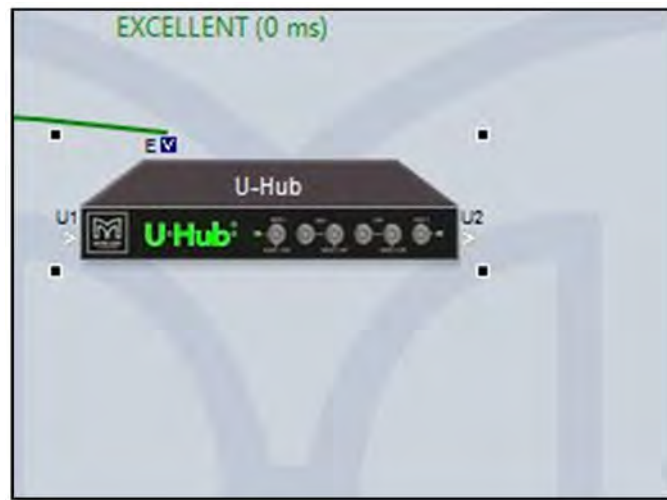

### Right Click Menu

Unlike other devices in Vu-Net, there is no internal processing, so all U-Hub functions are available from the right click menu which appears like this; -



#### *Locate*

This duplicates the double-click function to illuminate the front panel LEDs also turning the name green in Vu-Net.

#### *Synchronise*

Repeats the synchronisation that Vu-Net performs following device discovery.

#### *Disconnect / Reconnect*

This allows you to disconnect the U-Hub from Vu-Net and then reconnect

#### *IP Settings*

By default, the U-Hub is set to dynamic IP so will require a Lan with a DHCP server present to assign an IP. In a standard MLA system this is provided by the Zone Director housed in the Master rack. The U-Hub can be changed to Static IP for sophisticated networks which may be shared by many devices. Right clicking and selecting **IP Settings** opens this window; -

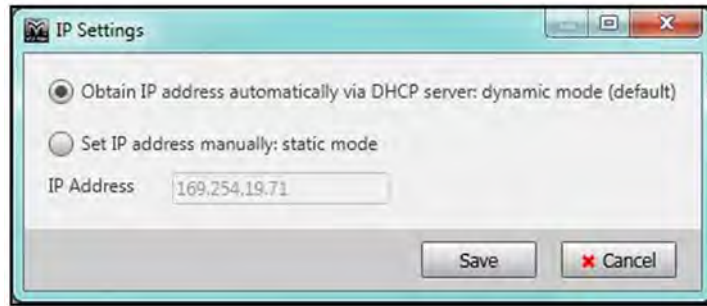

To change to Static IP, click on '**Set IP address manually: static mode**'; -

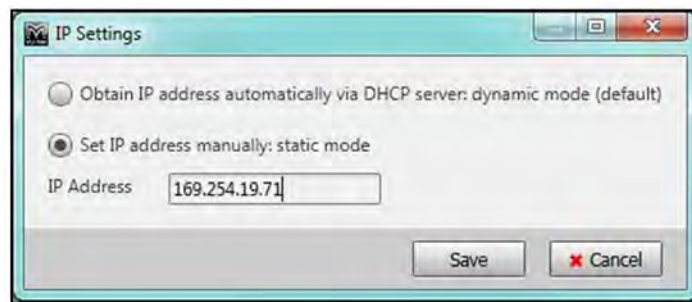

The default static IP is the same address that can be set using the front panel IP reset switch, 169.254.19.71. This can be changed to any IP address within the range you require for your network.

Once the U-Hub has been configured for Static IP the front panel Static IP LED will illuminate.

### *Rename*

You can give the U-Hub a name of your choice up to 32 characters; -

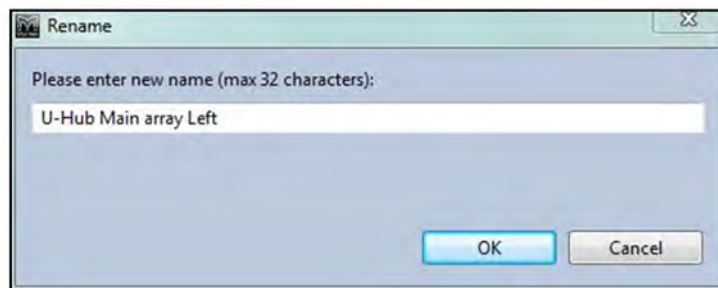

The keyboard shortcut to rename a U-Hub is F2.

### *Delete*

Removes the U-Hub from the system. This will open a confirmation window; -

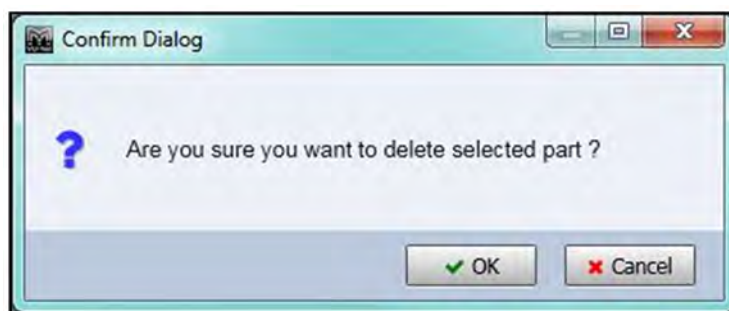

Click **OK** if you are sure or **Cancel** if not.



## DX4.0

The DX4.0 shares many similarities with the DSP in the IKON amplifiers making using both product types within Vu-Net very straightforward. The input and output structure is very similar to the iK81 as the DX4.0 is a 4 input, (8 Dante inputs) 8 output device.

As with IKON amplifiers, the Preset Manager allows factory presets for Martin Audio speaker systems to be easily loaded and Optimisations for O-Line arrays can also be uploaded so an O-line system can be run fully optimised using the DX4.0 partnered with an amplifier with a more appropriate output power capability such as the Martin Audio VIA2004.

A DX4.0 may be added to the Project either by dragging from the Palette in off-line mode or using device discovery when on-line. Off-line mode is useful only for getting familiar with editing amplifier parameters within Vu-Net. You cannot create an off-line project and upload to a DX4.0, as the Vu-Net environment depends on individual IP address for every device, you have to perform a Device Discovery to find devices that can be used in a project.

With the network established click on Discover Devices on the toolbar; -



A window will appear showing all DX4.0 found on the network; -

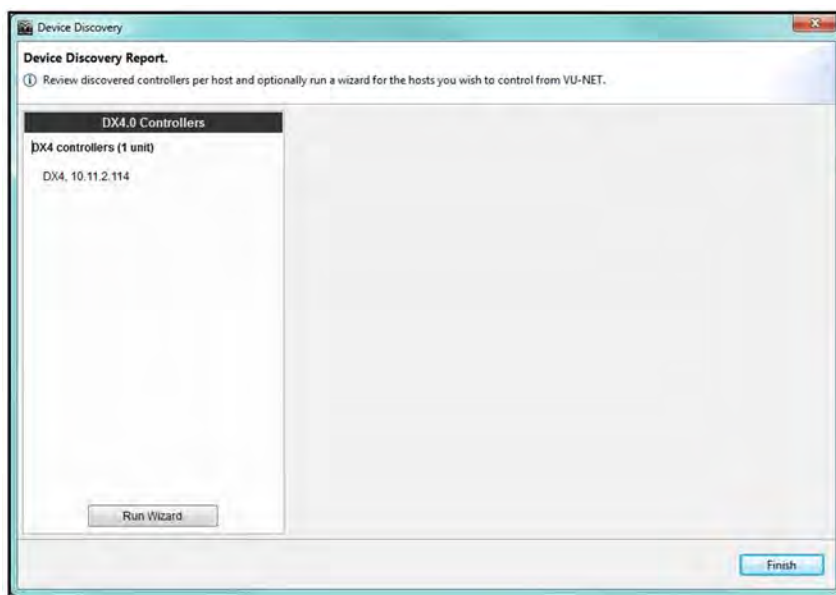

Click Run Wizard and you will see the following window following a successful synchronisation; -

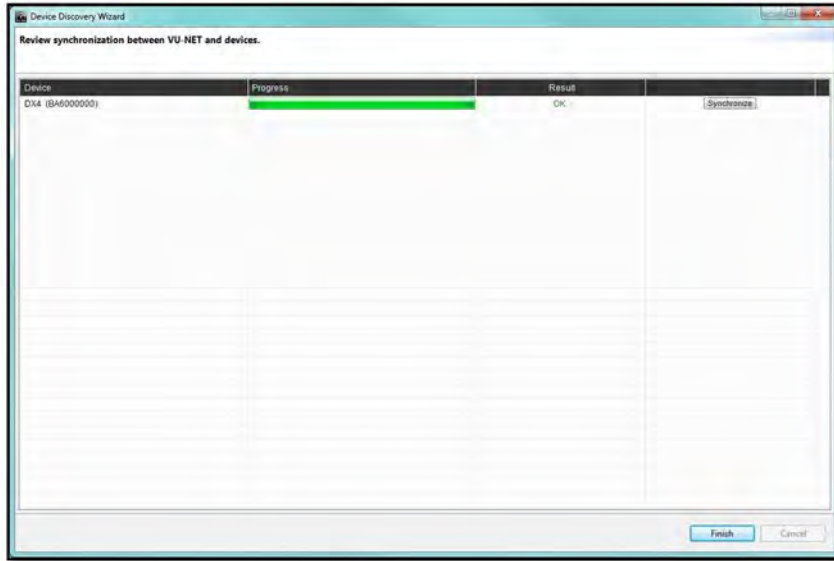

The DX4.0 will then appear in the System Diagram; -



### Right Click Menu

The right click menus has some important features for operation of a DX4.0; -

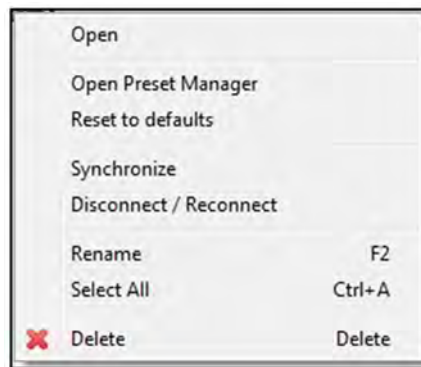

#### *Open*

This has exactly the same effect as double clicking on the processor thumbnail to open the editing window for all of the DX4.0 parameters.

#### *Open Preset Manager*

This opens the Preset Manager Window; -



Preset Manager is where the DX4.0 processors in the Project are arranged into racks and Presets are loaded (Preset Loader in the 'Tools' menu is not used with the DX4.0). Presets may be d2p files created for O-Line, or fixed parameter presets for LE monitors, SX Series Subwoofer, BlacklineX or other systems.

See the *Preset Manager Chapter*.

### Reset to defaults

This allows you to reset the DX4.0 to default settings which can save a great deal of time when configuring a processor which has been used on a previous job and has a large number of settings edited. As this is a highly destructive command the following windows will appear prompting you to confirm the action; -

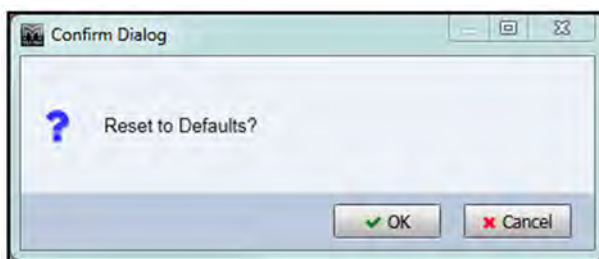

If you definitely want to reset the DX4.0 click **OK**, otherwise click **Cancel**.

### Synchronise

This will synchronise the settings in Vu-Net with those in the actual DX4.0. This may be necessary if there has been a loss of the network connection or a change has been made to the amplifier via the front panel controls.

### Disconnect/Reconnect

This allows you to disconnect individual processors from the network without having to disconnect the entire system from the network. The same button is used to reconnect an amplifier which has been disconnected.

### Rename

This allows you to give the DX4.0 a name of your choice up to a maximum of 30 characters. With the DX4.0 selected, the keyboard shortcut is F2.

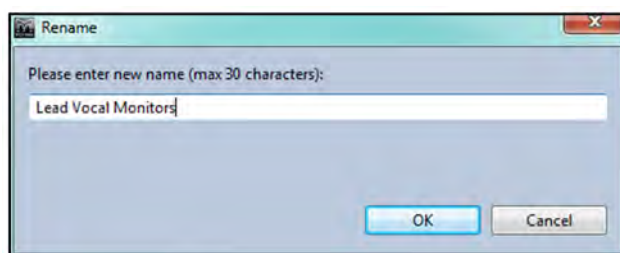

### Select All

This will select all devices in the project.

### Delete

Will remove the DX4.0 from the project. A window will request that you confirm the Delete; -



Click OK to delete the DX4.0 or Cancel to return to the screen

### Gain / Mute / Limiters

Double clicking on the DX4.2 icon in the System Diagram window or using right-click **Open** command will open a new tab which defaults to the DX4.0 Gain / Mute / Limiter window; -

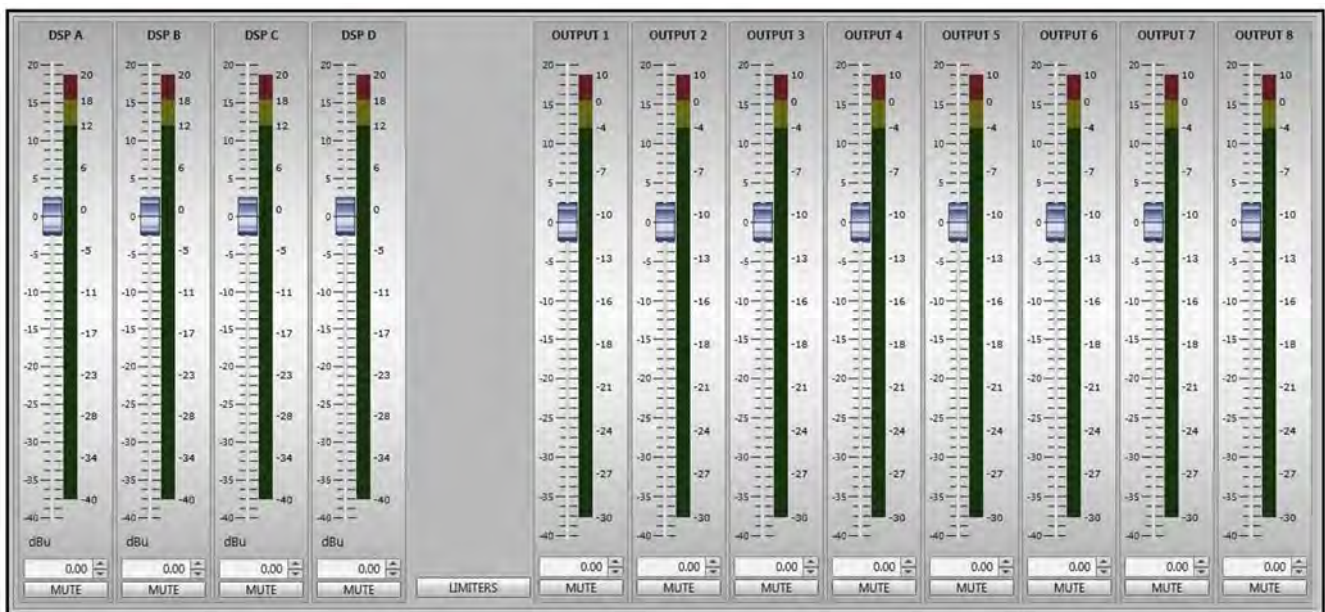

Gain may be adjusted in three ways. The gain fader for inputs and outputs can be drag and dropped to any position, a specific value can be typed into the window below the fader; -

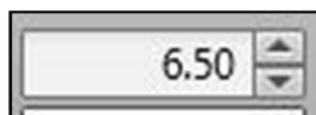

Finally, the value can be adjusted up and down using the arrows to the right of the gain value. The increments will be determined by the settings in Preferences. 0.5dB is the default. The gain range available for inputs and output is +20dB to -40dB.

The bargraph meters to the right of the faders display level for the inputs and outputs. Input level is post input select and Fallover trim but pre all other processing. Input level can be up to +20dBu. the meters display from +20 to -40 dBu.



The outputs meters display level prior to limit so the level at which they operate is entirely determined by the limiter threshold that have been set. For example, if the limiters have been left at the default settings with the thresholds left very high, 20dBu for the VX limiters, 110V for the TMAX limiter, there will be very little meter movement with a relatively normal signal level through the processor. If, however the limiters settings have been entered for a low power speaker system such as the Martin Audio Adorn series, with a fairly average signal applied there will be a lot of meter displacement as the limiter thresholds are low to protect the speakers. The scale shows dB before limit and ranges from -30dB up to -4dB where the scale turns amber, up to 0dB above which the meter turns red to show that the limiters are in operation.

All inputs and outputs can be muted independently. The mute switch is grey when the channel is un-muted; -



And red when muted; -



Between the input and output sections there is a button labelled 'Limiters'; -



This opens the output limiters; -

	OUTPUT 1	OUTPUT 2	OUTPUT 3	OUTPUT 4	OUTPUT 5	OUTPUT 6	OUTPUT 7	OUTPUT 8
<b>LIMITERS</b>								
	0.00	0.00	0.00	0.00	0.00	0.00	0.00	0.00
	MUTE	MUTE	MUTE	MUTE	MUTE	MUTE	MUTE	MUTE
<b>VX</b>	VX	VX	VX	VX	VX	VX	VX	VX
<b>Mode</b>	NORM VX	NORM VX	NORM VX	NORM VX	NORM VX	NORM VX	NORM VX	NORM VX
<b>Threshold</b> dBu	20.00	20.00	20.00	20.00	20.00	20.00	20.00	20.00
<b>Overshoot</b> dB	8.00	8.00	8.00	8.00	8.00	8.00	8.00	8.00
<b>Frequency</b> Hz	2000	2000	2000	2000	2000	2000	2000	2000
<b>Threshold Hi</b> dBr	0.00	0.00	0.00	0.00	0.00	0.00	0.00	0.00
<b>Overshoot Hi</b> dB	0.00	0.00	0.00	0.00	0.00	0.00	0.00	0.00
<b>TMAX</b>	TMAX	TMAX	TMAX	TMAX	TMAX	TMAX	TMAX	TMAX
<b>Threshold</b> V	110.00	110.00	110.00	110.00	110.00	110.00	110.00	110.00
<b>Attack</b> s	34.00	34.00	34.00	34.00	34.00	34.00	34.00	34.00
<b>Release</b> X	2.00	2.00	2.00	2.00	2.00	2.00	2.00	2.00
<b>XMAX</b>	XMAX	XMAX	XMAX	XMAX	XMAX	XMAX	XMAX	XMAX
<b>Threshold</b> V	208.93	208.93	208.93	208.93	208.93	208.93	208.93	208.93
<b>At Frequency</b> Hz	50.00	50.00	50.00	50.00	50.00	50.00	50.00	50.00
<b>Min Frequency</b> Hz	5.00	5.00	5.00	5.00	5.00	5.00	5.00	5.00
	WIZARD	WIZARD	WIZARD	WIZARD	WIZARD	WIZARD	WIZARD	WIZARD

Here are three limiter sections to offer the most comprehensive protection for your speaker system.



### VX

VX is a peak limiter. In normal mode the active parameters are Threshold in volts and Overshoot in dB. Overshoot prevents the signal from exceeding threshold during the attack phase of the main limiter by more than a predetermined amount. The optimal Overshoot setting is usually about 8dB. Lower Overshoot settings will sound progressively 'harder'.

When VX mode is active the VX button turns green; -



You can choose the crossover point of a 'virtual crossover', which incorporates two limiters per output so the user can individually limit the drivers in a passive 2-way enclosure using individual thresholds, and optimised attack and release characteristics for each. 'Frequency' sets the crossover point for the two limiters. The Threshold of the second 'Hi' limiter is set relative to the threshold of the first 'Lo' limiter.

### Tmax

Tmax is a thermal limiter designed to protect the drivers from damage caused by long-term exposure to excessive power beyond the AES rating of the driver. The threshold should be based on the drivers AES rating with the attack and release figures calculated from the voice coil diameter and the frequency band it is running.

### Xmax

The Xmax limiter protects against excessive excursion in the driver. As the magnitude of excursion is generally inversely related to frequency- i.e. the lower the frequency the greater the excursion likely to be experienced- the Xmax limiter is progressively more sensitive at lower frequencies and, rather than varying the gain to provide the limiting action, it uses a sliding high-pass filter to progressively curtail the low-frequency response, effectively limiting the linear excursion to below the X-max specification of the driver. Threshold is entered in Volts. Frequency sets the point at which the threshold voltage is appropriate. Min Frequency sets the minimum frequency below which the limiter action will level off. For most applications this can be left set to 5Hz.

### Wizard

At the bottom of the limiter window is the Limiter wizard button. Clicking on this brings up the Wizard window; -



The Wizard allows you to quickly set the optimum limiter settings for a speaker system. You simply select the type of speaker from the drop-down; Sub/LF/FR, MF, MF + HF, or HF. Enter the nominal impedance in Ohms, the voice coil diameter, the number of speakers per channel, the amplifier gain (by default this is 32dB which is the gain for the vast majority of professional amplifiers including all Martin Audio amps), the Amplifier continuous power at 4 ohms. Then click **Apply** and the limiter on that channel will be populated with the best settings to seamlessly protect the speaker.

## Routing

The routing window allows you to route signals between the input and output of the DX4.0.

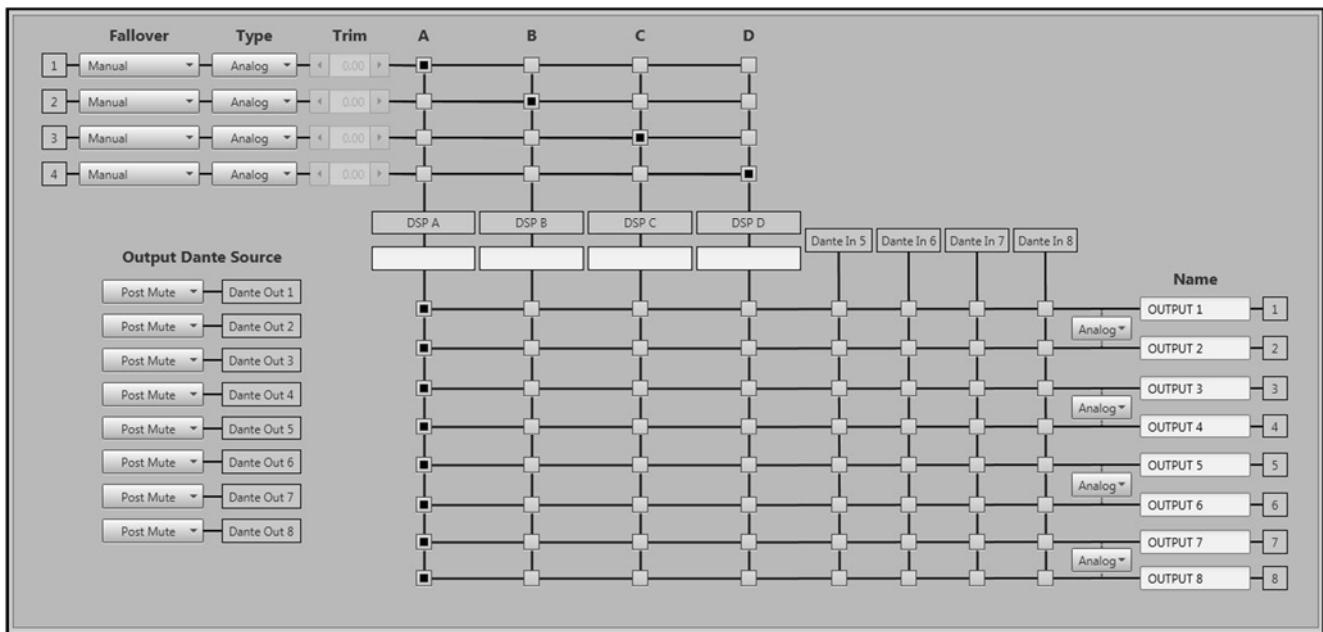

There are four inputs which may be analogue or AES3 from the rear panel XLR connectors, or Dante. There are a further 4 Dante inputs. There are 8 outputs. The rear panel XLRs can be either analogue or AES3 selected in pairs (as AES3 is a 2-channel connection). Outputs 1 to 8 are also permanently routed to Dante, the exact position in the signal chain for the Dante output feeds can be independently selected.

## Inputs

There are two selection options for each input, the type and the Fallover. Type may be selected from Analogue, AES3 or Dante. The AES3 connection will depend on the channel, AES connections must be made to input XLRs 1 or 3. Channel 1 and 3 have AES 1 available, channel 2 and 4 have AES 2 available. Note that it is possible to select input 1 (or 3) to be AES 1 and input 2 (or 4) to be analogue as input XLRs 2 and 4 will be available. You cannot select input 2 (or 4) to be AES 2 with input 1 to be analogue as those connections would both need to be made via the same XLR. Any input can be Dante. As digital formats inevitably have slight differences in level compared to analogue, a gain trim is available so that digital signals (AES3 or Dante) can be balanced with analogue; -

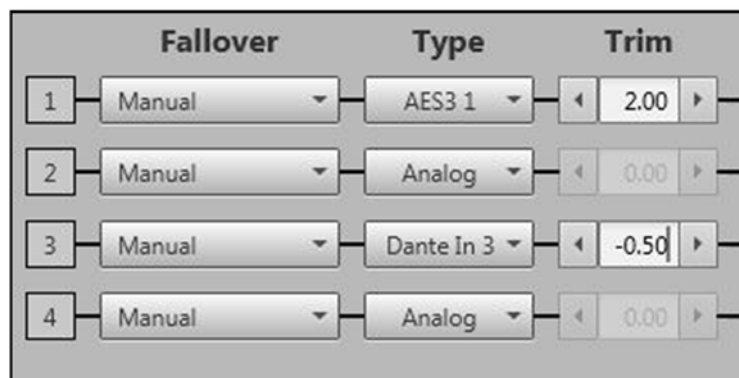



Fallover allows for a second connection to be made carrying the same signal as the Dante feed to provide redundancy in the event of a Dante network failure. There are three options; manual which will mean you will need to manually make an input routing change should the Dante fail, Dante to AES3 which will automatically switch to the AE3 input, and Dante to Analogue which will automatically switch over to the Analogue input.



**Pre-DSP routing**

Each input may be routed to any or all of the input DSPs using the routing matrix prior to DSP A-D. This may be used in a number of ways to arrive at practical solutions for system management. For example, perhaps you have a stereo signal from a DJ mixer going to inputs 1&2 and a console for live acts connected to inputs 3 & 4. You require master stereo feeds for the main system, a DL only mono feed and mono feeds for subwoofer and additional fills. If you nominate DSP A and B for stereo use and DSP C for mono, you can route in input matrix like this; -

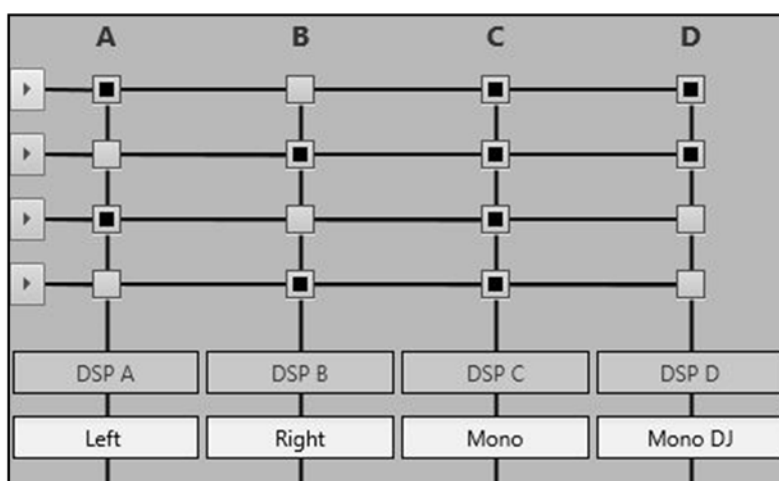

This gives you the capability of processing the stereo and mono feeds independently, adding EQ or delay as required. If you need to keep any processing precisely matched, between the left and right for example, the input DSP can be ganged, see the ganging chapter

The boxes below each input DSP allow a name of your choice to be entered up to a maximum of 12 characters

**Output Matrix**

Signals from the four input DSPs plus Dante inputs 5 to 8 can now be routed to any of the output DSP. Note that only one signal can be routed to each output, you cannot derive a mono sum for example from two signals, this needs to be done using the input matrix. The Output matrix also allows routing from Dante inputs 5 to 8.



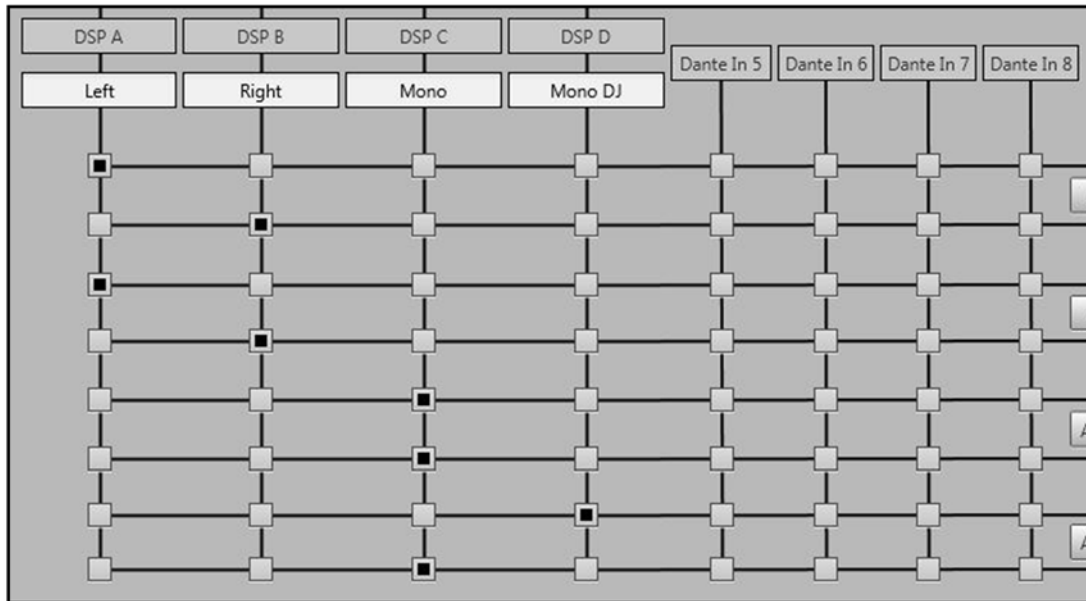

Outputs may be either Analogue or AES3 selected in pairs. Dante outputs are available simultaneously with whichever mode is selected for the output XLRs. A box allows a name to be entered for each output up to a maximum of 9 characters.

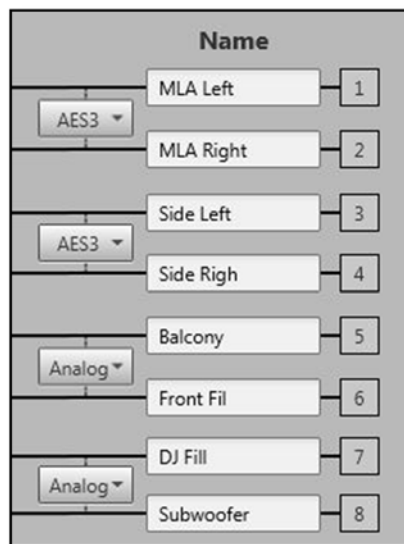

**Dante Outputs**

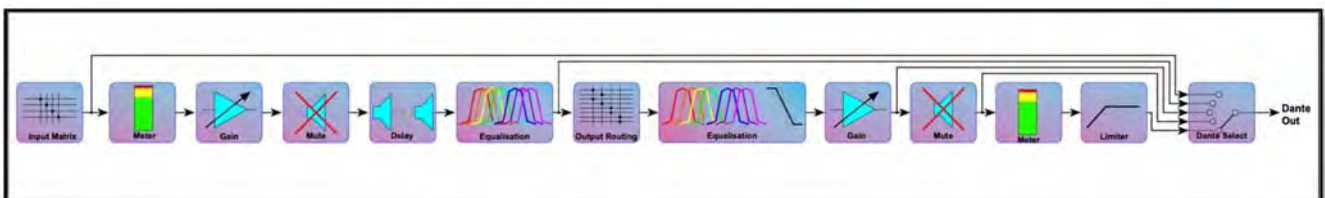

All 8 output channels are available as Dante outputs and each Dante output can be individually routed from a number of positions in the processing chain. These are Input DSP input, Input DSP output, Pre-Mute, Post-Mute and Post-Lim. Post limiter will match the standard XLR outputs.

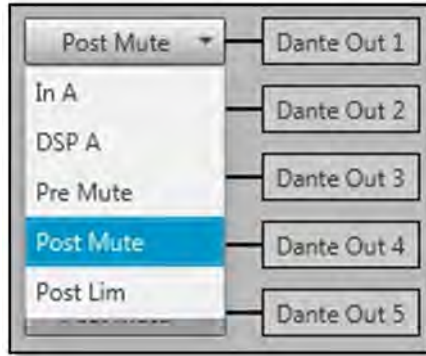

Outputs 5 to 8 are not associated with an input DSP so have the option of Pre-Mute, Post Mute or Post Limiter; -



**Input DSP**

The four channels of Input DSP are labelled A to D and may have any combination of the input connection routed to their inputs (with the exception of Dante inputs 5 to 8). Input DSP parameters are accessed via the DSP ABCD tab



This allows adjustment of all EQ and shares its format with Equalisation windows in all other Vu-Net devices. The channel to be adjusted is selected using the buttons at the top left of the screen; -



EQ bands are adjusted by moving the cursor over them, clicking once which selects the band and they can then be dragged to change the frequency and gain.

Filter bands can also be selected by clicking on the Filter buttons above the graph; -



Selected filters have a blue button, any filters that have a gain setting other than 0db (i.e. they have been adjusted) will have green buttons. Bypassed channels will be red. Note that by default the Hi-Shelf filter is bypassed as this is an FIR filter and adds to the latency significantly.

All channels can be bypassed by clicking on the Bypass PEQs button which turns all buttons red; -



This is a temporary bypass which can be reversed with a second click on the Bypass PEQ button. All previous PEQ settings will be restored.

The overall equalisation shape is shown with a white trace, the response for the selected band is shown in red. This shows EQ band 6 selected; -

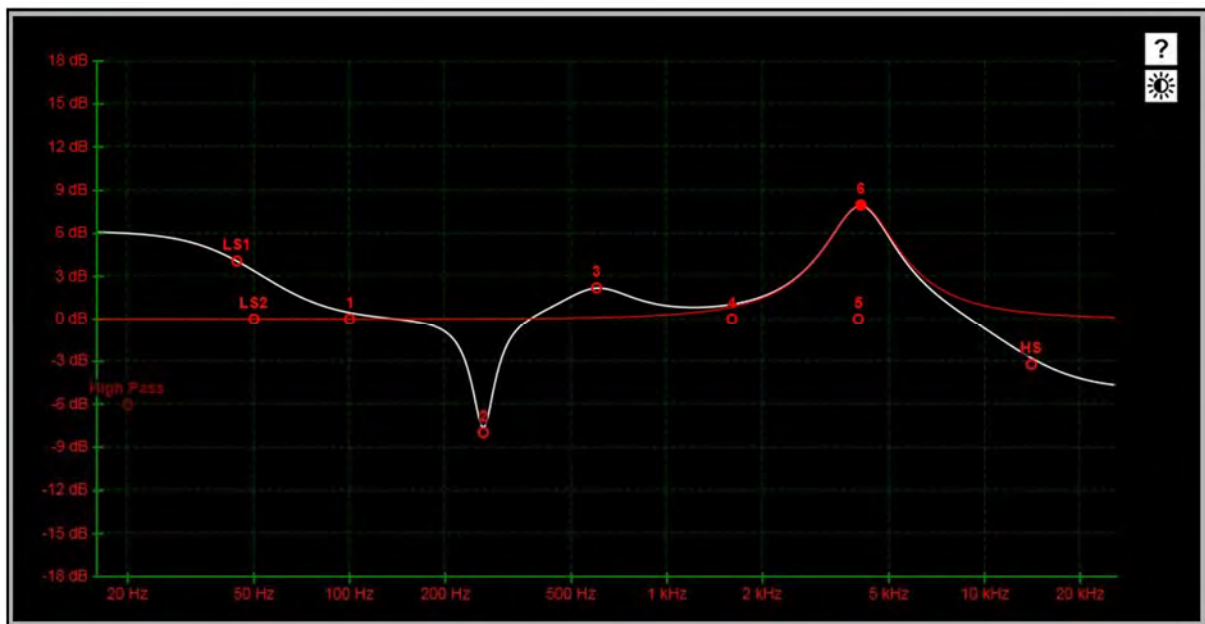

**Show All** will display the curves of all four channels simultaneously; -

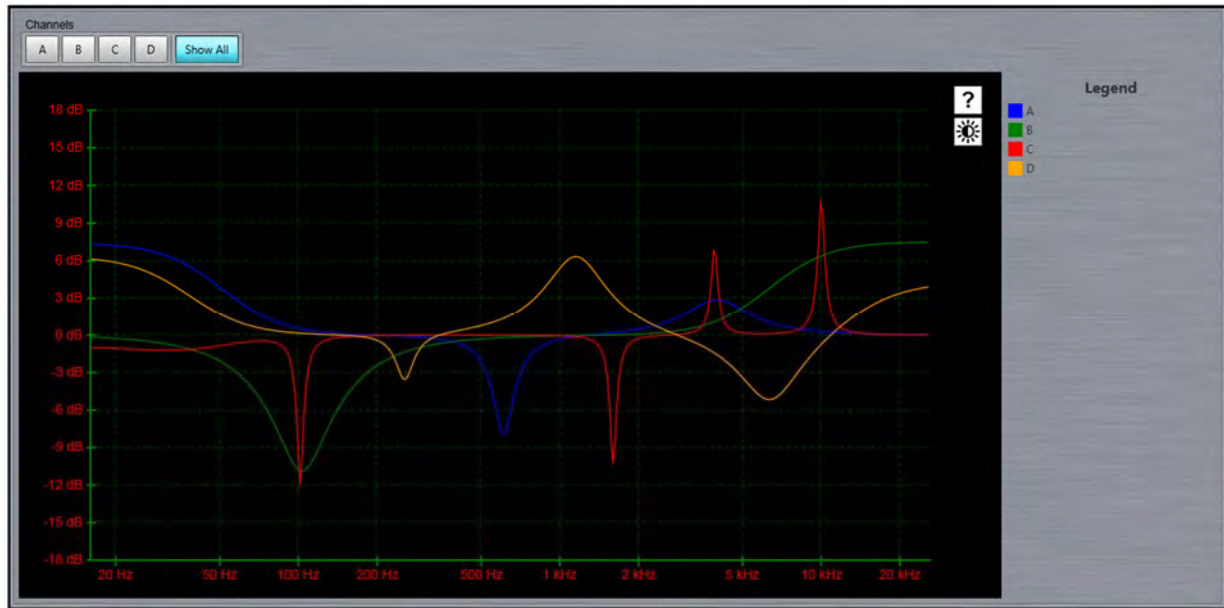

The key to the trace colours as displayed on the right are; -

- Blue Channel A
- Green Channel B
- Red Channel C
- Yellow Channel D

There are two icons in the top right corner to assist with using the EQ graph. The First; -



Is a help function which brings up the following window; -

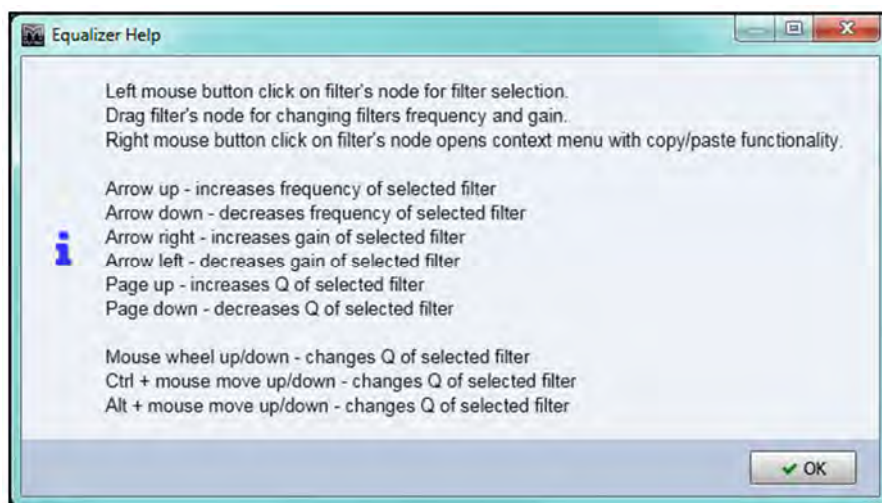

This shows how to change settings in the EQ graphical window using keyboard shortcuts.

The second symbol; -



Changes the display mode to daylight operation for when using Vu-net in bright conditions such as outdoors when configuring a festival system. The EQ view will reverse and appear like this; -

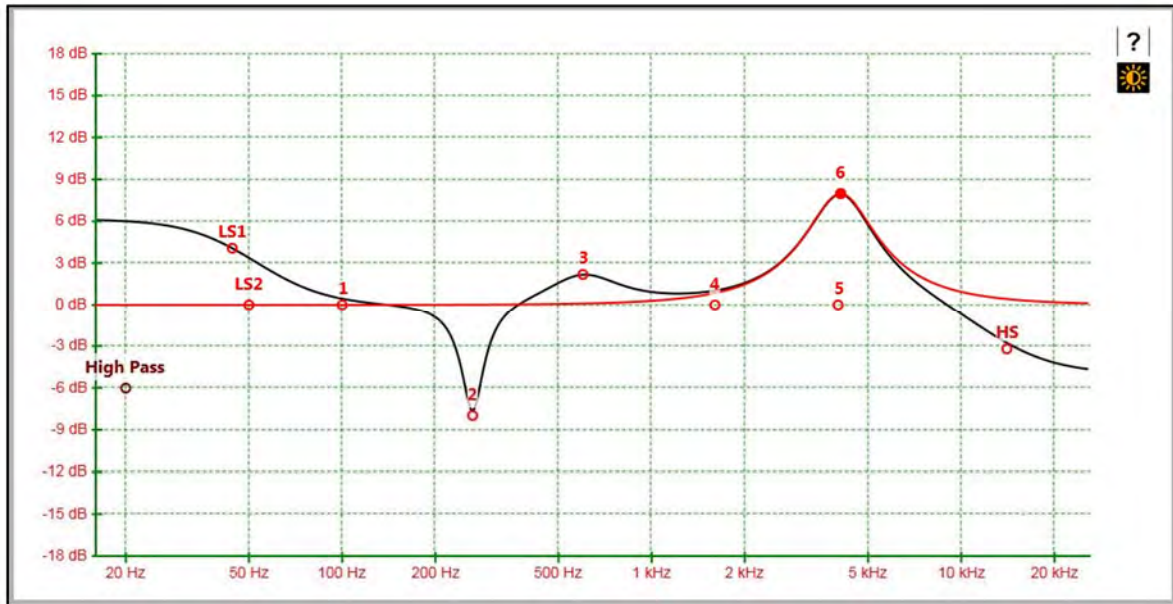

As shown in the help window, there is a copy and paste function available by selecting an EQ band and right-clicking; -

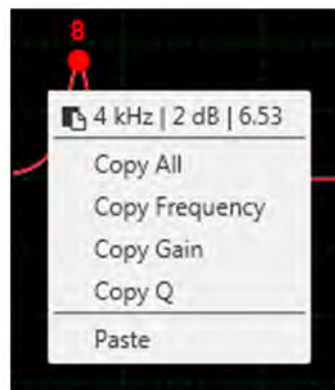

At the top is a summary of the selected EQ showing its frequency, gain and Q Factor. You can choose to copy all three filter parameters, just the frequency, the gain or the Q. You can then click on any other filter in any of the inputs or outputs and right click selecting Paste to transfer the parameters.

The section on the right offers a precise method for adjusting EQ parameters. This section will be active for whichever filter band is selected. This is showing the parameters for channel A band 6; -

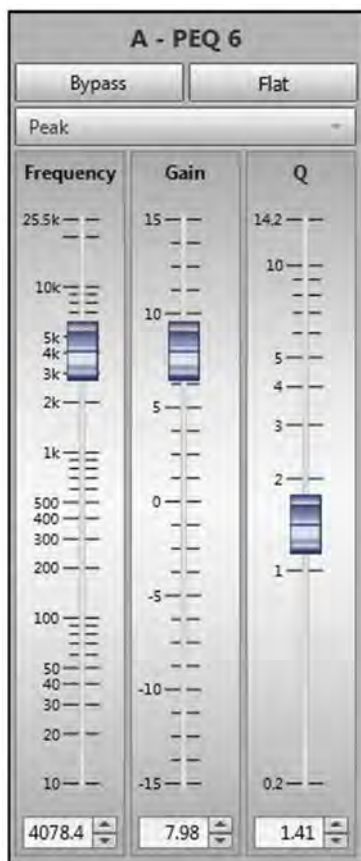

At the top is a Bypass button. This will retain the parameters set for the EQ band selected so they are not lost but will bypass the equalisation.

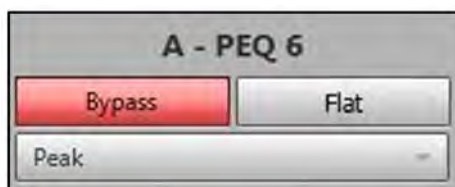

The graphical view will change accordingly; -

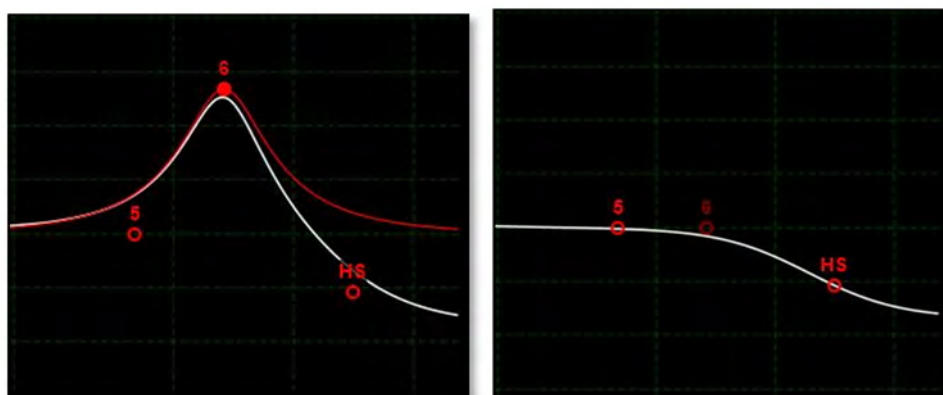

The EQ trace flattens and the band number greys out.

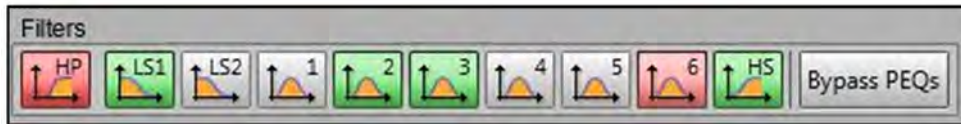

Next to the Bypass button is 'Flat'. As you might expect this zeros the gain of the selected band. It is "destructive" meaning once flattened you cannot return to the previous value although the frequency and Q values are not affected.

Below the Bypass and Flat buttons is a display showing the filter type; -

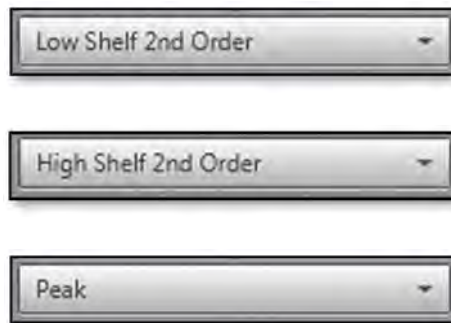

The High Pass filter has options for Bessel, Butterworth and Linkwitz-Riley; -



LS 2 & 2 are 2<sup>nd</sup> Order Low Shelf, band 3 is a 2<sup>nd</sup> order high shelf, bands 1 to 6 are parametric ("Peak") filters. The High Shelf filter is a 2<sup>nd</sup> Order but incorporates FIR filtering.

The three faders for Frequency, Gain and Q can be adjusted in three ways for precise control of these parameters. First you can click on the fader knob and drag it to the required position to adjust the value. The value displayed in the box below the fader will adjust in real time.

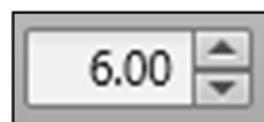

You can also use the up and down arrows to adjust the value, the increments are set in the Vu-Net preferences. By default the gain will increase or decrease in 0.5dB steps. Finally, you can click on the value and directly type exactly the value you need.

## Output Channels

The output channel tab is almost identical to the input channels; -



The channel being viewed is selected by the Channel buttons top left.



The filter band is selected using the filter buttons or by clicking on the filter in the graph; -

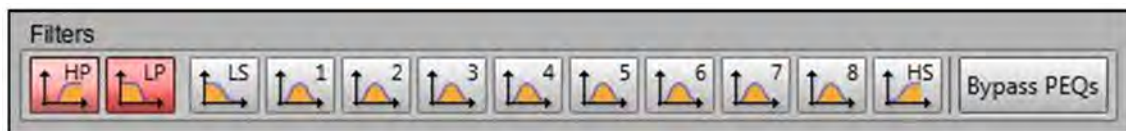

There are high and low pass filters, a low and high shelf filter plus 8 bands of parametric or All Pass EQ.

As with the Input EQ, filter gain and frequency can easily be edited directly in the equalisation graph by clicking on the numbered dot representing each filter band and dragging it to the required position. There are keyboard shortcuts as for the input EQ; -

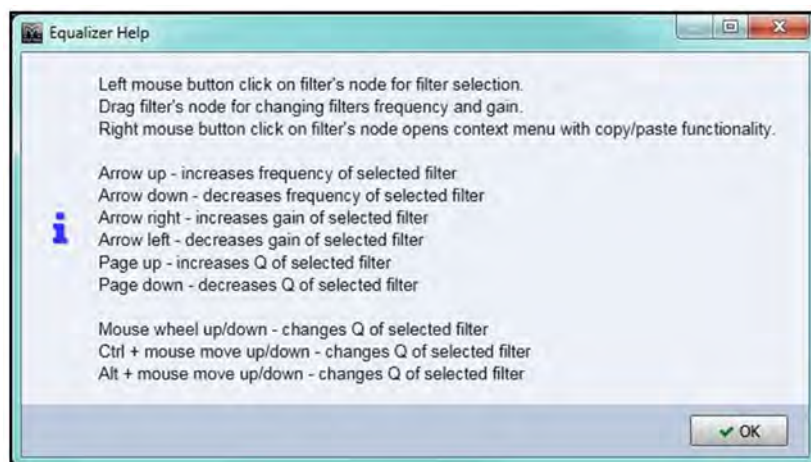

And you can also select daylight mode; -



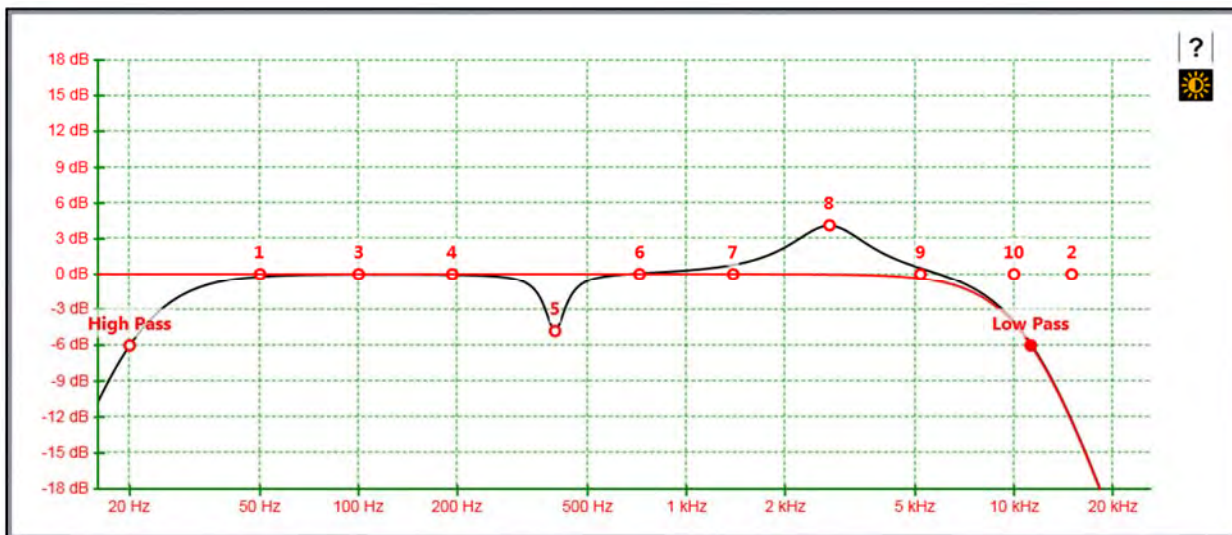

Also identical to the input EQ is the facility to directly edit values for a selected EQ filter using the panel on the right; -

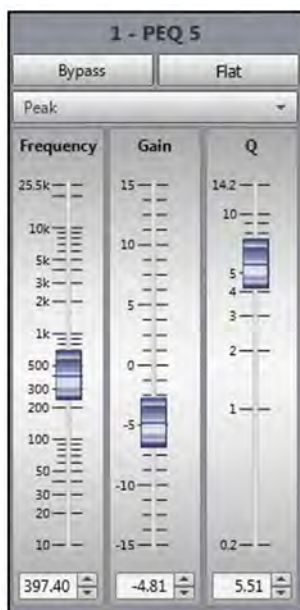

The Parametric filters 1 to 8 operate in exactly the same way as those in the input EQ and values can be copied and pasted between them if required using a right click with the cursor over the band you wish to copy from and paste to.

In addition, output PEQs can be changed to All Pass filters using the drop-down box; -

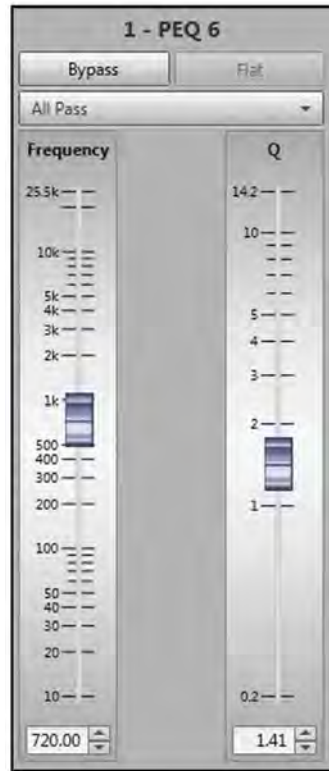

Note that there is no graphical representation of an active All Pass filter as it effects phase only, there is no change to the frequency response so the graph isn't affected. The button in the Filter list shows that the filter is now operating as All Pass; -



And the filter button in the graphic window will change to blue. It will remain on the 0dB line as an All Pass filter doesn't affect gain, but it will move either by being dragged or in conjunction with the filter fader to show the frequency at which the All Pass is operating; -



The high and lowpass filters are both active by default. The filter type for each can be selected from the drop-down box above the Frequency fader; -

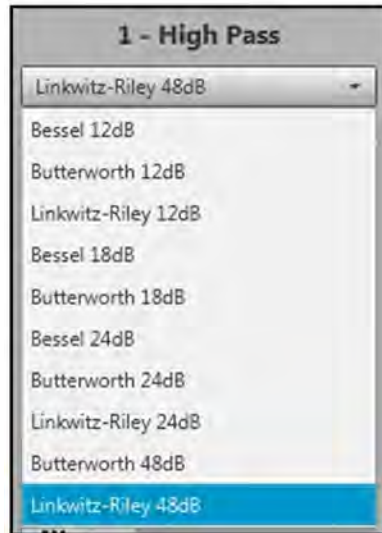

**Delay**

The Delay tab has a similar system overview as the routing showing signal flow and Output DSP names.

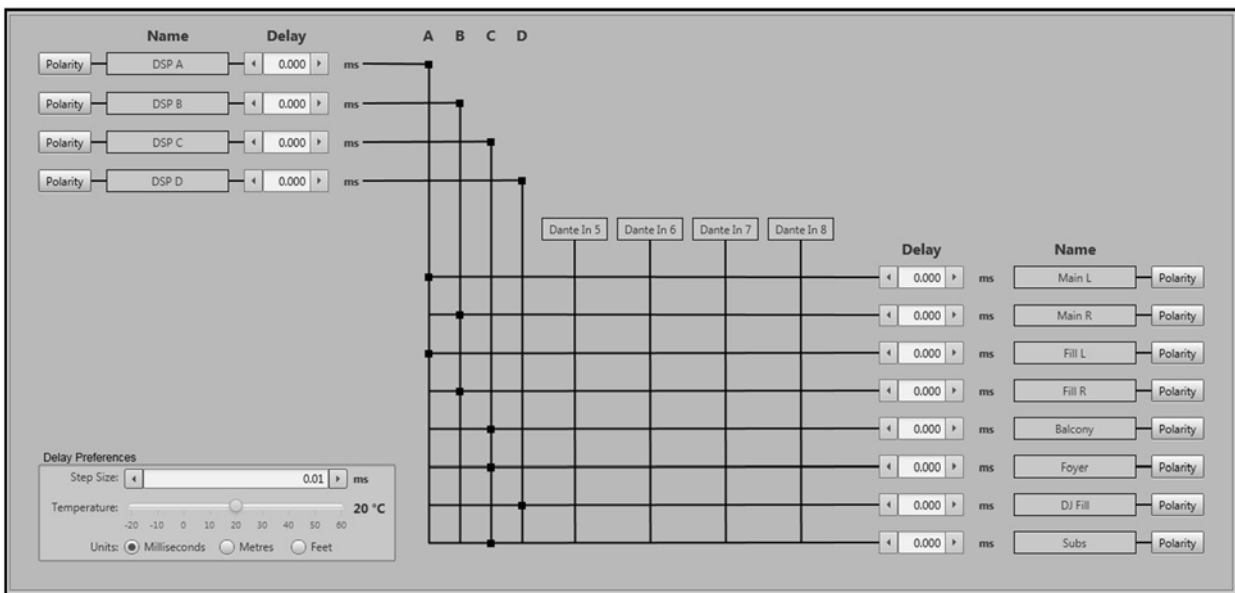

There are three sections to the window. The input delays including polarity; -

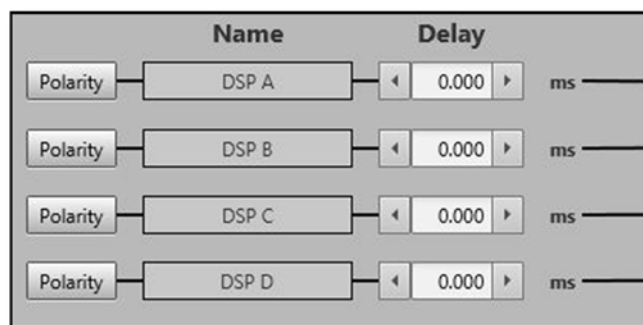

Output delays; -

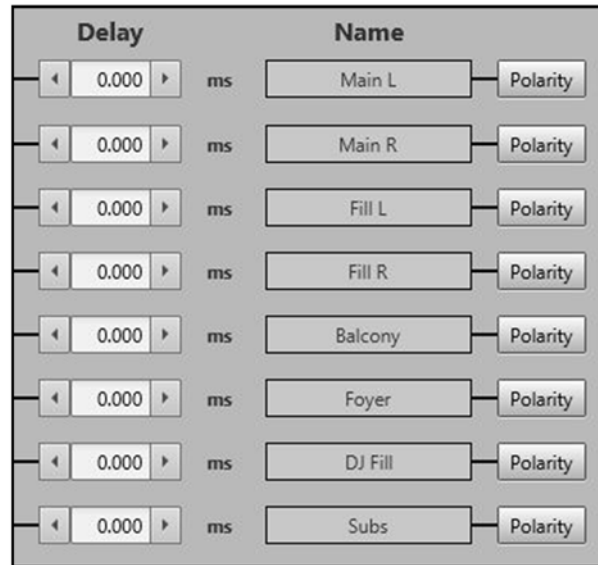

The final section is the delay Preferences; -

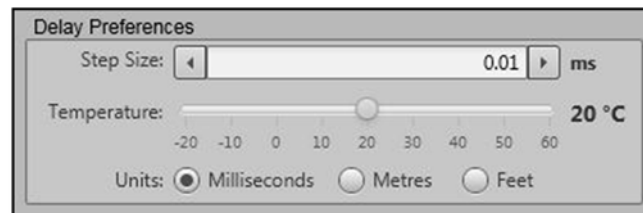

First it is worth looking at the Delay Preferences. Step Size determines the increments that the delay will increase or decrease if the up/down arrows are used for adjustment. This ranges from 0.01 to 100 milliseconds. Units: selects the measurement units displayed for delay which can be either Milliseconds, Meters or Feet. Temperature is used to enter the room temperature when delay figures are entered, should the temperature change you can move the temperature slider to the new reading and delay values will automatically update to compensate for the different speeds at which sound travels through air depending on temperature.

Input and Output delays operate in identical fashion, delay can be either directly entered- any value from 0 to 998ms, or a starting value can be entered and you can use the arrows either side of the value window to adjust the value in steps. The size of step is set in the Delay Preferences section.

The final feature on the delay tab is Polarity. This reverses the polarity on the output changing the button colour to green; -



## Ganging

DX4.0 may be ganged in a similar way to other Vu-Net devices. Open the ganging window and select DX4.0 from the tab at the top; -



All DX4.0 in the project will be displayed; -

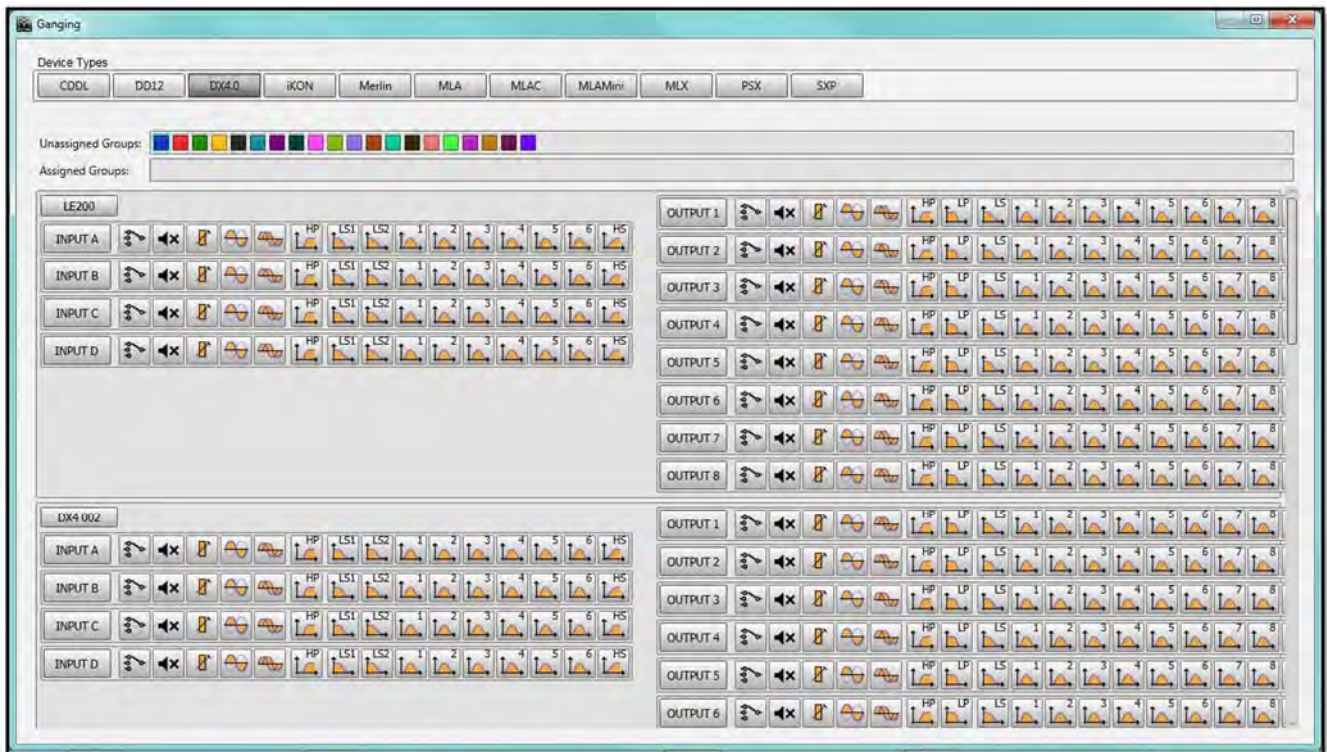

These can be ganged in several ways. First we can gang entire processors together. In this project we have two DX4.0 both driving LE200's, we can gang both Processors together so that any changes to one will be matched in the second. The first step of any ganging procedure is to select a group. There are twenty of these represented by different colours and with no gangs set, all 20 will be unassigned; -



The next available gang is always highlighted so unless we want to use a different colour we can proceed by clicking on the name of both of the DX4.0 driving LE200. These are labelled "LE200 A" and "LE200 B" in our project, this is prior to ganging; -

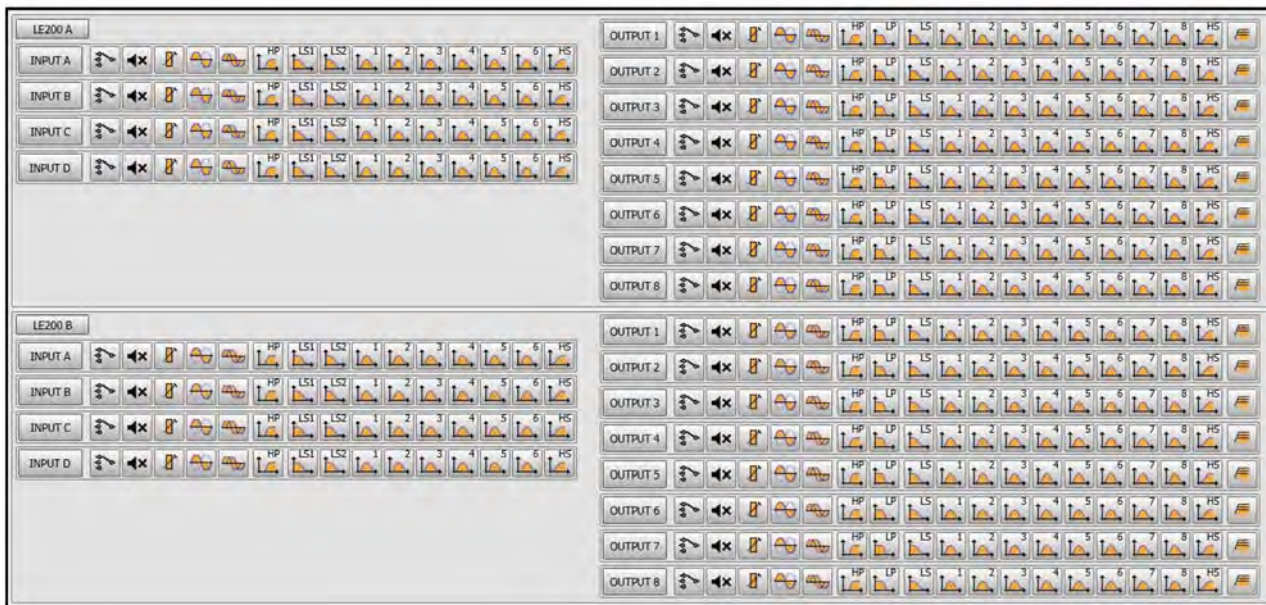

And here they are ganged; -



Now any changes on any parameter on "LE200 A" will be matched on "LE200B". Vu-Net has automatically assigned 8 groups to match the number of channels.

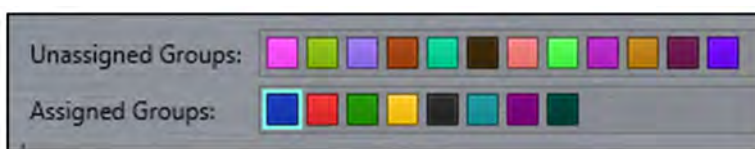

There are two important things to note. Although input channels 1 to 4 are in the same ganging group as output channels 1 to 4 this does *not* mean that inputs and outputs are ganged. You can only gang the same parameter types. Secondly, ganging for variable parameters such as gain is always *relative* so if a value already exists on one parameter when that is ganged to another the value remains and any subsequent adjustments will retain the difference between them. For example, if you have two processors one has a gain or +6dB on Channel 1 the other has 0dB on Channel 1. If you gang those parameters, the +6dB remains. If you now increase the gain on either amplifier by say 3dB, the first amplifier will now have a gain or +9dB, the second 3dB. If

you were now to *reduce* the gain by 10dB, the first amplifier will have a gain of -1dB, the second will be at -7dB. The 6dB difference between the two will always be retained.

Now back to our DX4.0 processing monitors. The ganging we have used is actually not really what we want. It is easily removed by clicking again on the amplifier name button and all the coloured ganging indicators disappear and all ganging groups are unassigned. Now click on the label for Output channel 1, channel 3, channel 5, and channel 7 of both amplifiers. Go to the Unassigned Groups and click on a colour, red is next, and now click on Output channel 2, 4, 6 and 8 on both amplifiers. It now appears like this; -



This makes far more sense for our two amplifiers. All the odd numbered outputs are driving the LF on our bi-amped monitors and all the even numbers are driving the HF. We can enter the parameters on one pair of channels and these will be matched on all of our outputs, thus our monitors are perfectly matched. The input EQ is left un-ganged so we can use it for independent EQ to ring-out any feedback for example.

This is a great solution however, when we are setting up we may wish to mute and un-mute outputs independently. This is easily achieved just by clicking on the mute button in the ganging page for all outputs; -



This removes them from the gang groups and they will now operate independently whilst all other parameters remain ganged; -



As well as entire Inputs and outputs, individual parameters can be grouped in the same way, select an unassigned group and click on all the parameters you wish to be ganged; -



To remove a parameter just click on it again. If you wish to add more parameters to the same group, click on the colour of the group you wish to edit from the Assigned Groups list at the top of the page then click on the parameter button or buttons you wish to add.

Ganging as you can see is a very quick and simple process that makes it very quick and easy to set up processors to drive a system without having to duplicate entering of parameters.

**Preset Manager**

Preset Manager is an extremely powerful feature that allows presets for Martin Audio systems to be quickly and easily loaded into a DX4.0. It allows you to create your own presets, perhaps for legacy Martin Audio systems. It handles snapshot management for quick recall of settings which remain sorted in the processors and finally it is possible to load the optimisation file for an O-Line system that has been created using Display 2.2.

Note that O-Line is the only d2P optimisation file that can be loaded, files for Wavefront Precision arrays will not be recognised, these systems can only be used with Ikon amplifiers.

**Rack Management**

The first stage of configuring a system is to arrange the DX4.0 into racks to mirror how they are physically deployed. In a fixed installation they may well be in one large 19" installation rack, however in a touring environment it is likely that they will be distributed across several racks, perhaps one in each amplifier rack.



When DX4.0 are added to a project either by dragging across from the Palette when in off line mode or using Device Discovery they will all be added to a single rack, This (off line) project has six DX4.0s. Right clicking on any of the processors in the System Diagram window and selecting **Open Preset Manager** will bring up the following window; -



The Number of racks is shown at the top left with up and down arrows to adjust the quantity; -



To the right is a guide to the colour coding of processor channels. This will reflect what presets have been assigned to the channel as we will see later in this chapter. As none of our DX4.0 have had a preset assigned, all channels are white; -



Finally, the rack with all DX4.0 is displayed. The processors are in the order in which they were added to the project or discovered so at present are in no particular order. If you need any assistance identifying amplifiers you can use the Identify switch; -



This will flash the LCD screen of the DX4.0 to help pick it out in a large system.

The first step is to increase the number of racks to the quantity that we wish to use by clicking on the right-hand arrow on the Rack Quantity button; -



Our window now appears like this; -

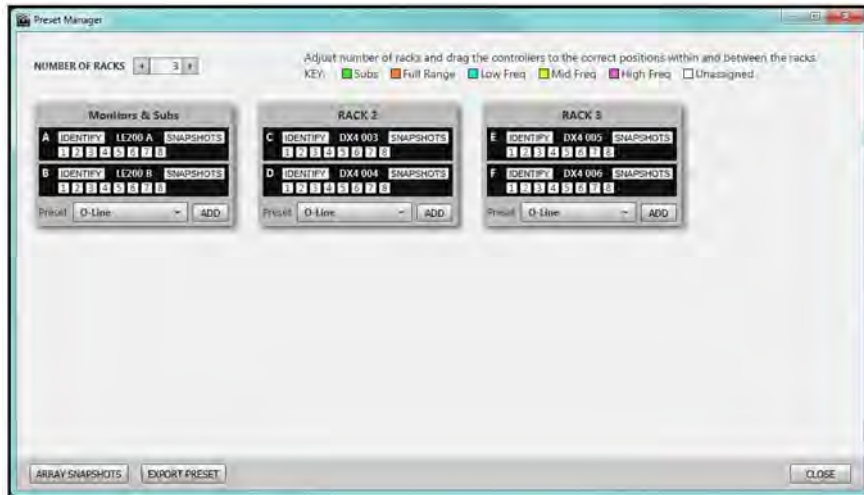

We now have three racks but the processors are still in a random order. Perhaps we would like the two DX4.0 driving LE200 to be rack three, this is easily achieved by dragging and dropping racks between racks. We can start by clicking on the first DX4.0 labelled "LE200 A" in rack 1 and dragging it over to Rack 3; -

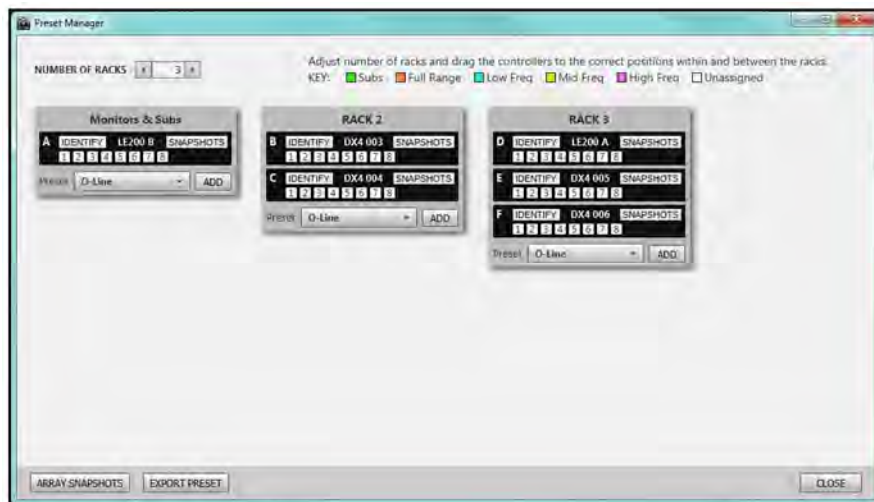

Now click on DX4.0 E in rack 3 and drag it to rack 1 (You cannot at this stage drag "LE200 B" into rack 3 as that would leave the rack empty and we have dictated that we have 3 racks)

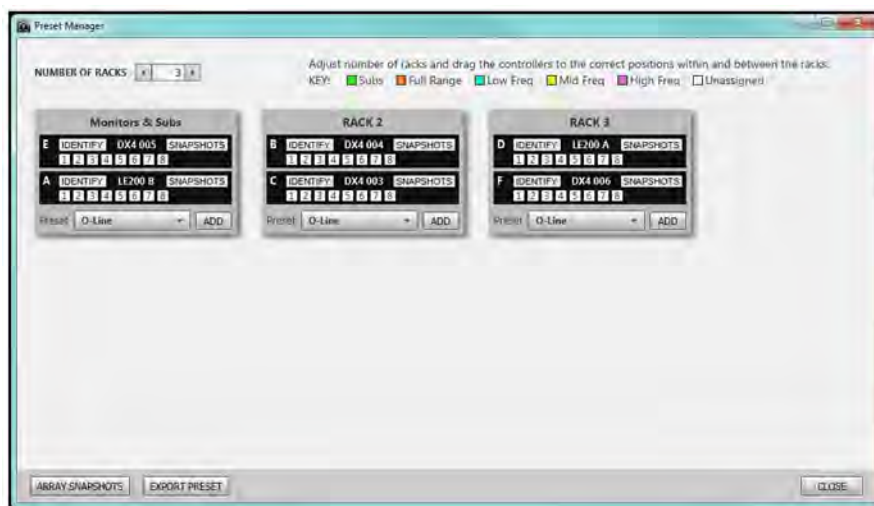

Now repeat the process swapping “LE200 B” in rack 1 with F in rack 3

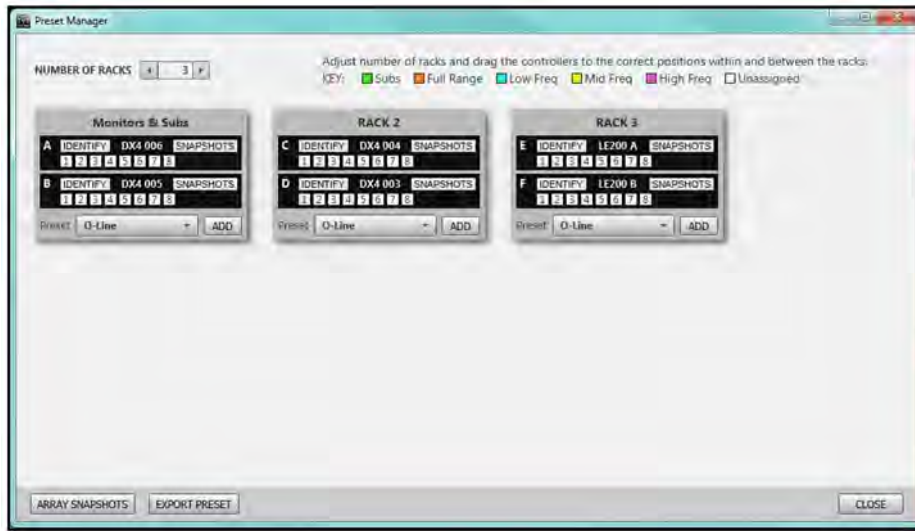

The DX4.0 are now arranged into the racks as we require them. We now may wish to return to the System diagram to rename both racks and individual processors to show their functions; -

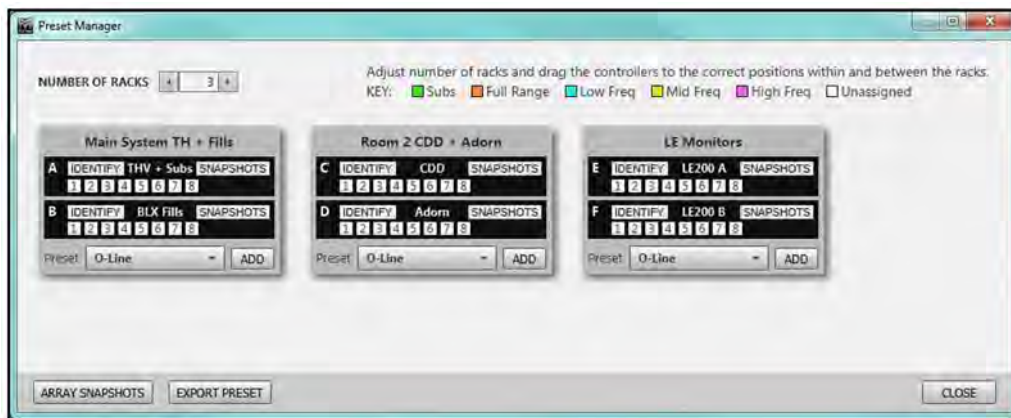

### Preset Loading

Loading Presets is easily achieved using the Preset Manager. Preset loading for O-Line arrays is a little more involved where an optimisation file created using Display 2.3 is being used. We will first look at loading regular system presets. A full set of presets can be loaded into all DX4.0 in a rack simultaneously if they are all using presets from the same group of products but you can revisit the preset loading at any time to upload new presets into any or all of the amplifiers.

In our first rack "Main System TH + Fills", our first DX4.0 has been named "THV + Subs" so we will load THV presets into four channels (stereo bi-amped), and subs into the remaining channels.

First Preset selection button at the bottom of the rack (showing O-Line by default) and select TH Series from the drop-down



Now click **ADD** to bring up this window; -



Now click on **Select** and choose **THV High Pass**. This preset includes a high pass filter for system which are accompanied by a sub woofer; -



This window gives you the opportunity to select which input channel and DSP will be populated with the preset. There are two options for input EQ, **Preserve** allows you to retain any previous EQ you have entered or **Flat** will flatten all input EQ in the selected input DSP. You have the option to enter the gain for the amplifier that the DX4.0 will be feeding, this ensures that the limiter parameters will adequately protect the speaker. By default this is 32dB which is the standard for professional amplifiers including all Martin Audio amps. Once these selections have been made click **ADD** and the window will show the first two channels populated with the THV parameters; -

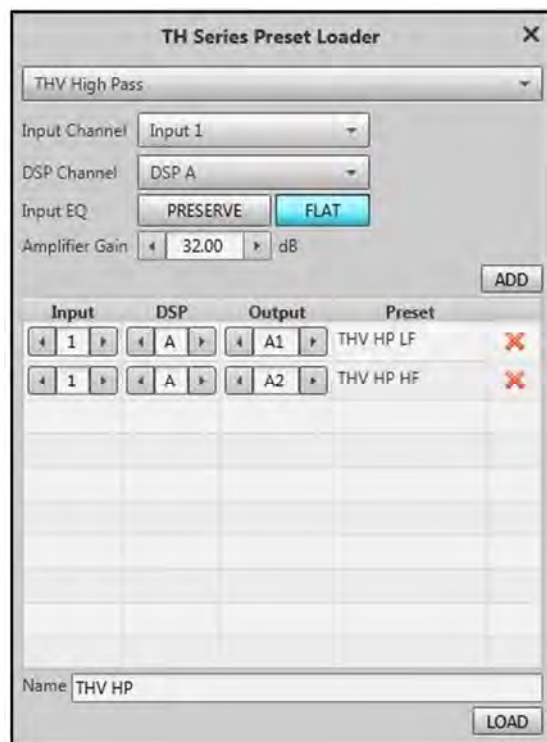

As the system we are building is stereo we can add a second THV, changing the input to channel 2 and the DSP to B and again clicking **ADD**;



As the THV is a bi-amplified system, two output channels have been populated with the system parameters. We can now add the subwoofer preset. To return to the Preset manager window click on **LOAD**. This will upload the parameters into the DX4.0. You will see that in the Preset Manager rack, outputs 1 to 4 of the first DX4.0 are now colour coded to represent the parameters that have been loaded;

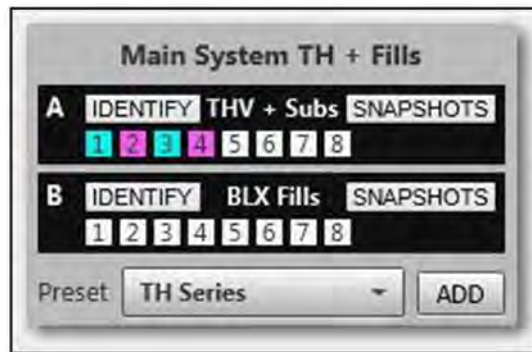

Thumbnails of two THV cabinets have also been added;

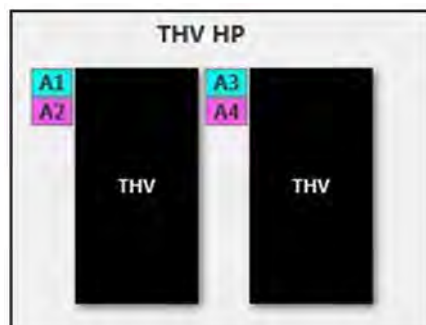

We can return to the same processor to add the subwoofer parameters. Select **SUBS** from the drop-down menu, click **ADD**. We will use the SXC118 single 18" cardioid sub (which requires two channels, one for the forward facing 18" driver and one for the rear facing 14" driver). We will select Input 3, DSP C and Flat and click **ADD**; -

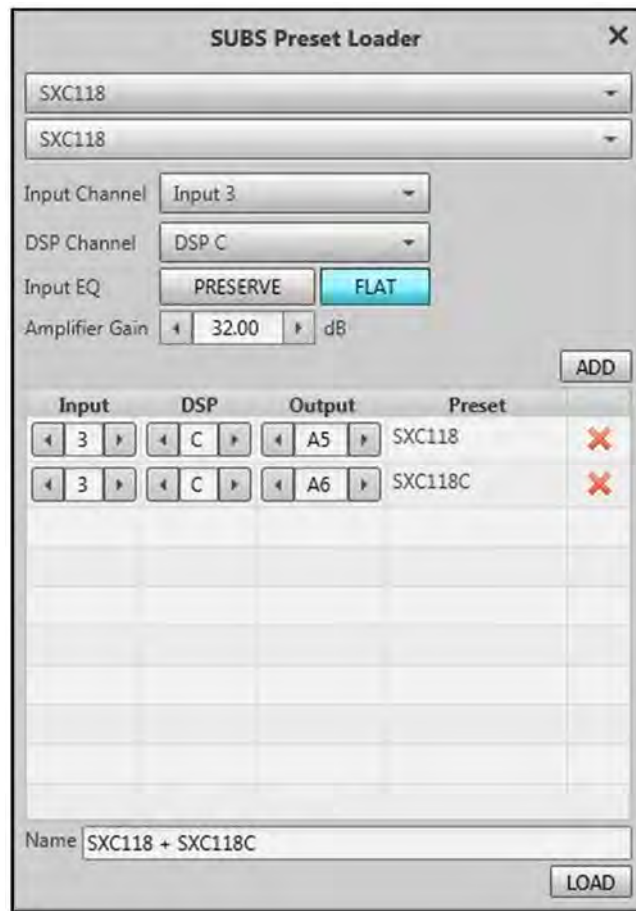

Click **LOAD** and the sub parameters are loaded into output channels 5 and 6 of the DX4.0. The thumbnail in the Preset Manager window will show the channels shaded green to show they are running sub signals; -

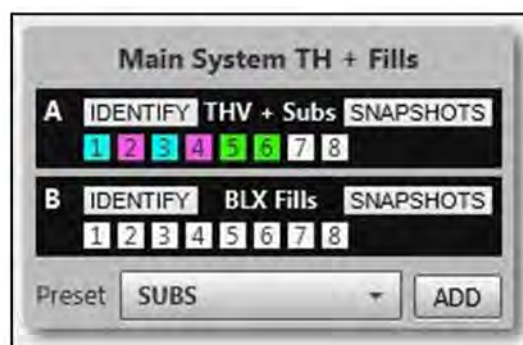

We also now have a thumbnail of the sub tagged to show which processor channels are controlling it; -

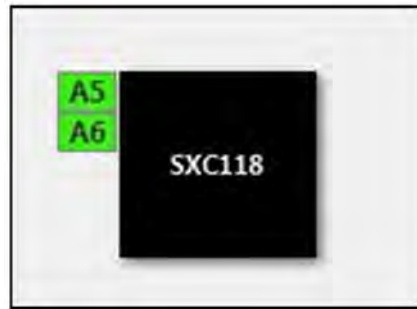

### Loading O-Line Optimisation files

O-Line arrays can be optimised using Display 2.3 to provide the best possible performance from an array. It is possible to choose the resolution of the array during the design process which determines how many channels of processing are required. For example, a 12-module array optimised at 12 box resolution will require 12 processing channels which would have to be split over two DX4.0, the first 8 channels in one and the final 4 channels in a second. At the other end of the spectrum you can optimise the entire array so only a single channel is required; the performance therefore being controlled more by the acoustic properties of the array including the angles between modules which is also calculated by Display 2.3. We will demonstrate loading an optimisation d3p file by using a design using a 16 module array optimised at 2 box resolution which will require 8 channels of processing- an entire DX4.0.

Open Preset Manager and click **ADD** (O-Line is the default option). The Preset Loader window will open; -



Now click the select button next to the D2 Preset File section and navigate to the d2p file created for the O-Line array using Display. The window will now show the file location. Now use the Preset drop-down to select the preset you wish to use. An optimisation file can contain a number of possible presets; perhaps several attempts were tried to obtain different results. The other option available is the Emergency Default which will load basic crossover settings suitable for O-Line without any optimisation coefficients. If you select the Preset you want to use the Preset Info section will display the array detail extracted from the file, in this instance 16 modules of O-Line at 2 box resolution. It will display the Array Name and default locations within the DX4.0 into which the parameters will be loaded; -



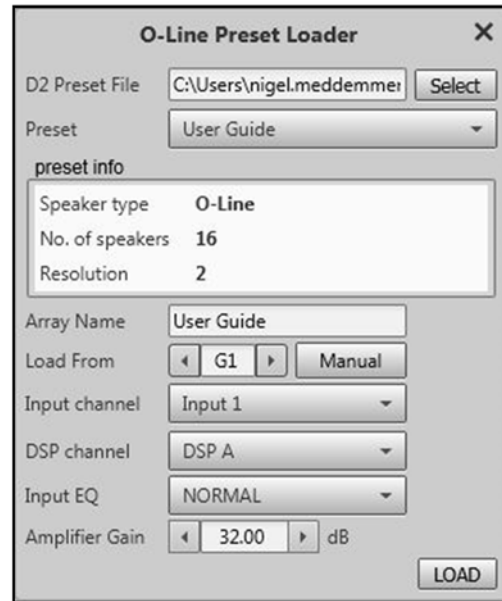

We can make any changes to the routing we need or accept the defaults including the gain of the amplifiers which will be driving the array we can click **LOAD** and the parameters will be uploaded. The DX4.0 will show all 8 output channels fully loaded with full range signals and an O-Line array thumbnail will be added; -

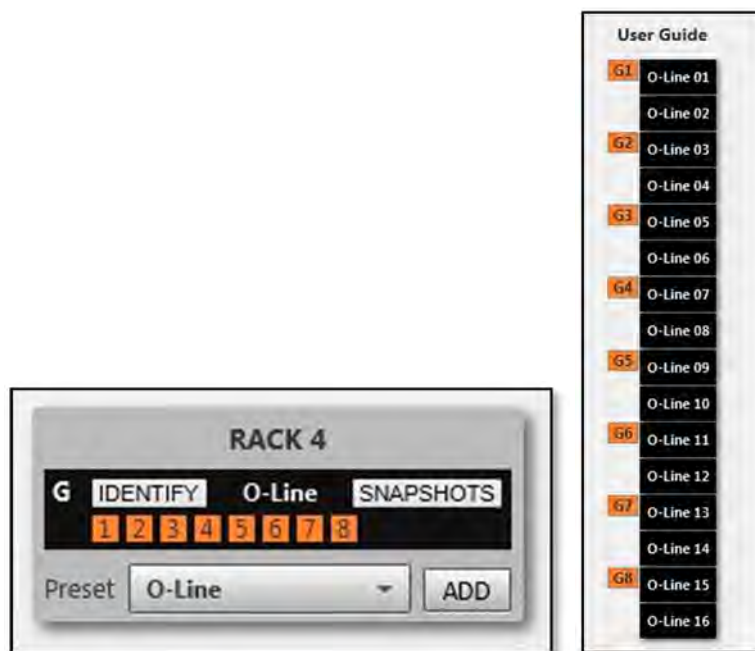

Note that loading presets makes most of the DX4.0 output parameters inaccessible. This is to preserve the settings to ensure the best performance from the speaker. The input DSP is still available for any EQ or delay that may be required to suit personal taste or to compensate for room acoustics. If for example we look at the output EQ for the DX4.0 with an O-Line optimisation loaded; -



We can see that all output DSP selection buttons are highlighted, and all the EQ is greyed out with the exception of the high pass filter giving you the option of changing the high pass for applications where you might be using the O-Line array with a subwoofer. This is very clear in the ganging window; -

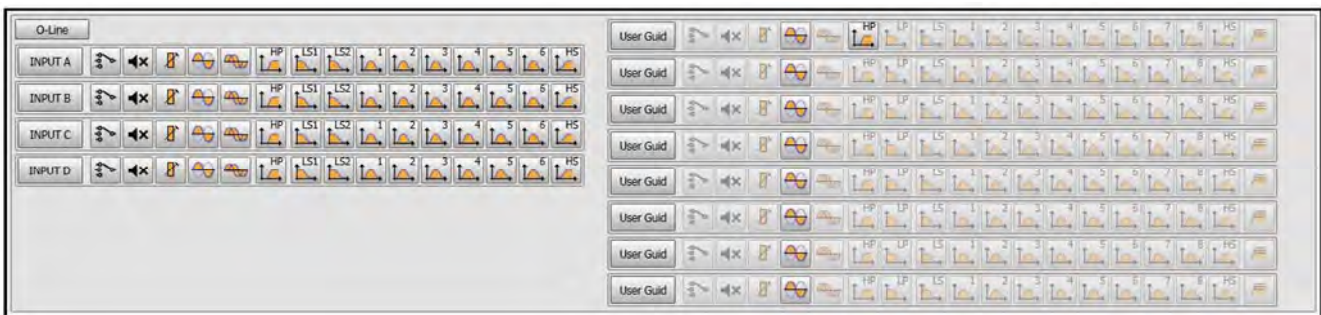

We can see at a glance that all output parameters are greyed out with two exception. The first is the phase filter for changing polarity. This is still available as an emergency fix for speaker cable faults; should a cable be wired incorrectly it is possible that one or more speakers in an array may be out of phase which will completely ruin the performance of the carefully optimised array. The second is the high pass filter in output 1. As mentioned previously, the highpass filter is left accessible so that it can be deployed at a suitable frequency should a subwoofer be used with the system. You will notice that the high pass is only accessible in channel 1, channel 2 to 8 are greyed-out. These all have a factory gang which cannot be disabled to ensure that any high pass applied to channel one will be consistently applied to all output channels thereby ensuring consistency across the entire array.

### User Presets

In addition to the vast library of Martin Audio factory presets, it is possible to create your own system presets for products not supported. Perhaps you have some legacy Martin Audio speakers that you still use, or products from other manufacturers. Creating your own preset makes it very quick and easy to load parameters for these speakers for any future events. To demonstrate we will create a preset for the Martin Audio W8C. The W8C is a tri-amp enclosure so first we need to add the correct parameters to three channels in the DX4.0 and route them from a single input. Parameters for all Martin Audio products including legacy ranges no longer manufactured can be downloaded from the Martin Audio website from the Loudspeaker Settings page accessed from the Support menu.

Here we can see the parameters entered into the DX4.0; -



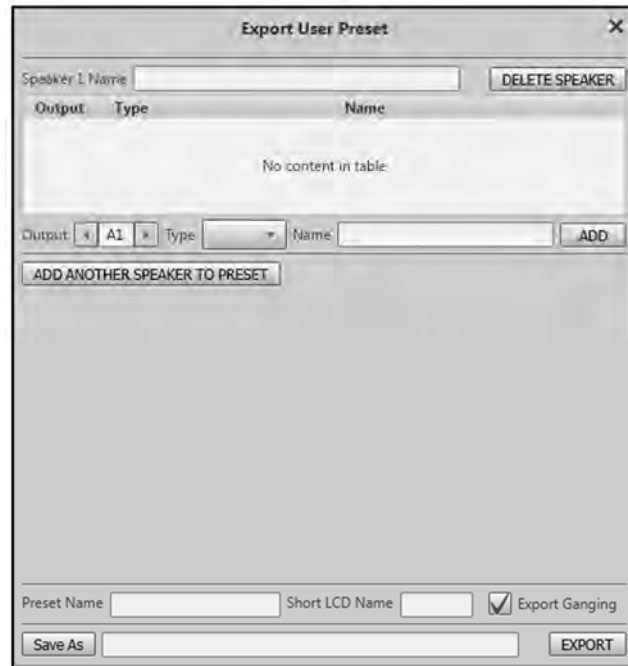

First name the Speaker, in our example W8C. Now use the Type drop-down box to select what output A1 will be driving, in our case LF. The name will default to the speaker name with "LF" added. This is usually acceptable but can be over-written if required. Now click **ADD** and the first element is added; -

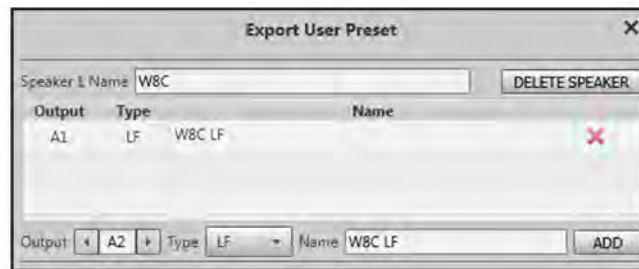

The output selection now jumps to the next channel. Change the output type to "MF", accept of re-name the output and click **ADD**. Repeat with HF for the third channel; -

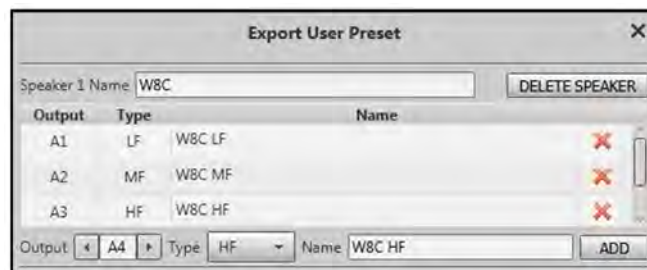

We can add a second speaker to the preset by clicking **ADD ANOTHER SPEAKER TO PRESET**. This would be used if for example you were creating a preset comprising a sub and mid-high speaker; -

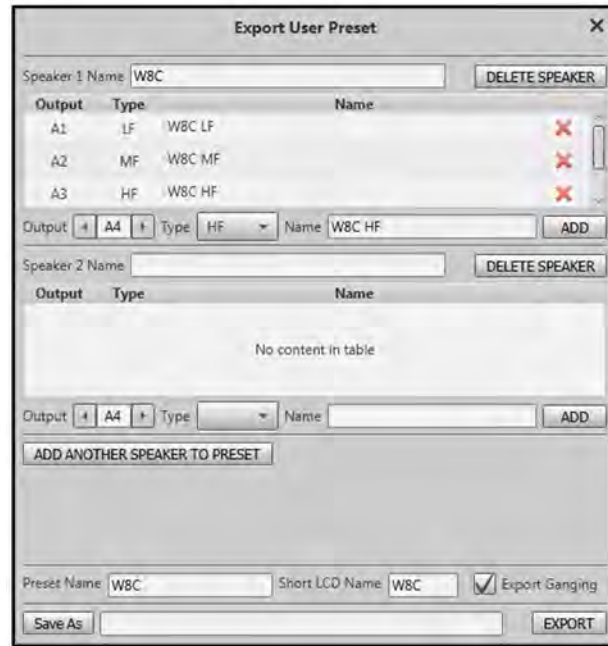

Follow exactly the same process to add the channels used for the second speaker. This is not required for our preset so we can click on **DELETE SPEAKER** to remove the second section. At the bottom of the window we can give the Preset a more descriptive name and an abbreviated version which will appear on the DX4.0 LCD display.

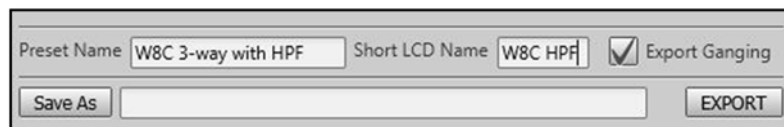

Now click on **SAVE AS** and navigate to a suitable file location on your PC in which to store the file and click **EXPORT**. The file will be created and you will see this window; -



You will also see in the Preset Manager window that a speaker thumbnail has been added and the iK42 channels colour coded to show that they are driving LF, MF and HF; -

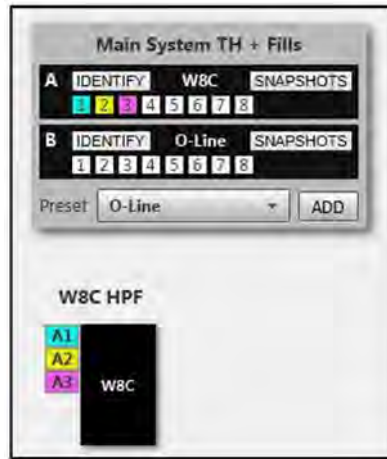

Now we can go to another DX4.0 and select **USER PRESET** from the drop down selection and click **ADD**; -



Click **Open** and navigate to the file location where the W8C Preset file was saved. The preset can now be added to the Processor in exactly the same way as a factory preset; -



### Snapshots

Vu-Net can manage snapshots which are stored within each DX4.0 to allow up to 20 configurations to be stored and easily recalled for any common applications where the same settings may be required. As well as storing a complete overview of any single processor there is also the ability to store the channels used in an O-Line array configuration, even if these are spread across several DX4.0 as is likely to be the case when running larger arrays with a high resolution.

Snapshots are accessed from the Preset Manager window. Each DX4.0 has a snapshot button; -



And the Preset Manager Window has an Array Snapshot button; -



If we look at the example of our project with the first DX4.0 driving W8C (from the User Preset) and subs plus second DX4.0 driving an O-Line array, opening Preset Manager appears like this; -

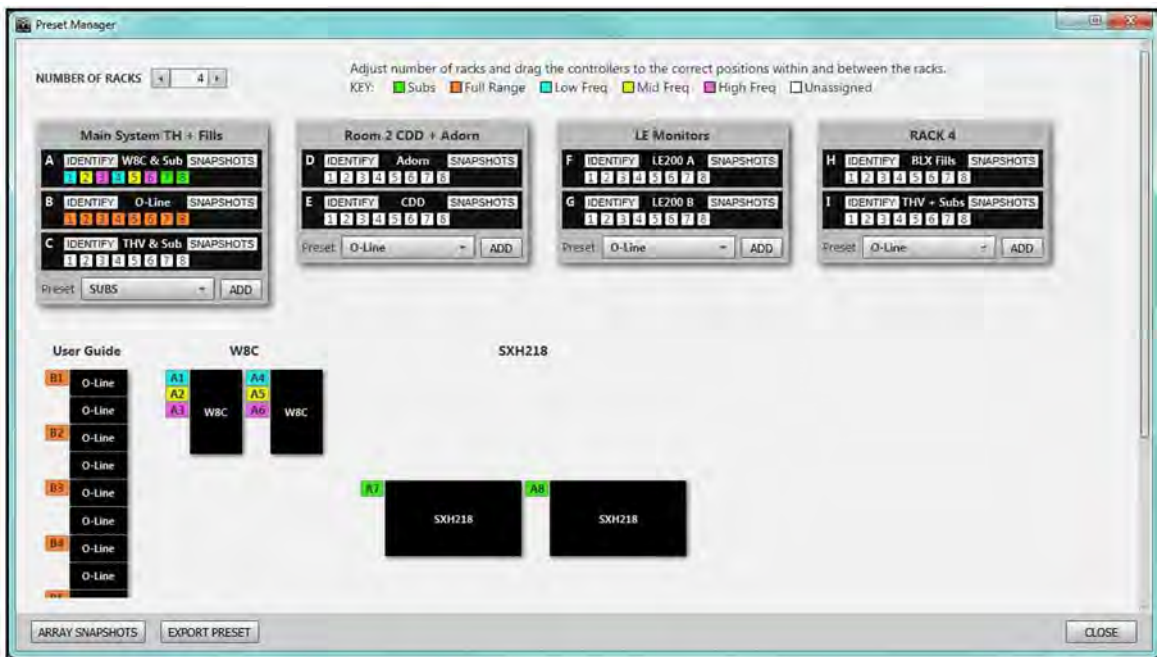

If we click on Snapshot on the first DX4.0 the Snapshot window appears; -

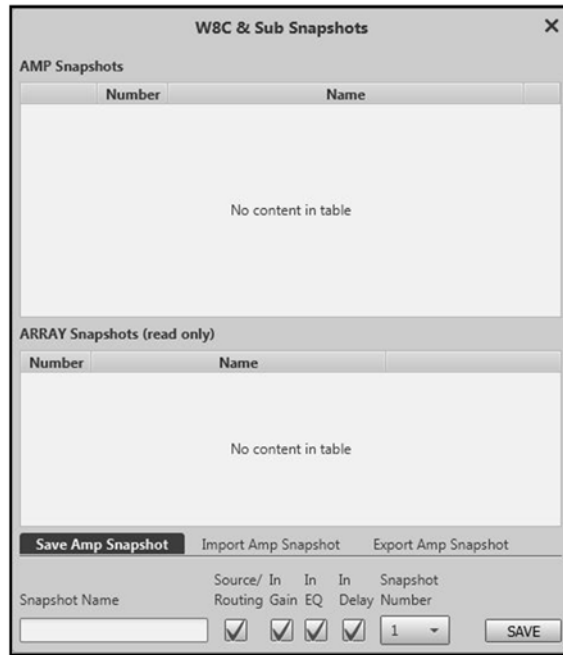

We can create a new snapshot by typing in the Snapshot Name Box.

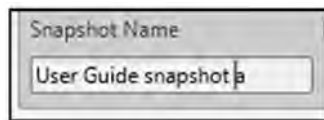

Next select which parameters are to be stored; - Source/routing, Input Gain, Input EQ and Input Delay (output settings are always included).

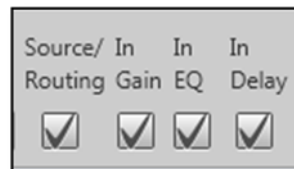

Now select which location number to store the new snapshot.



Now click **Save** and the Snapshot will appear in the list of Amp snapshots; -



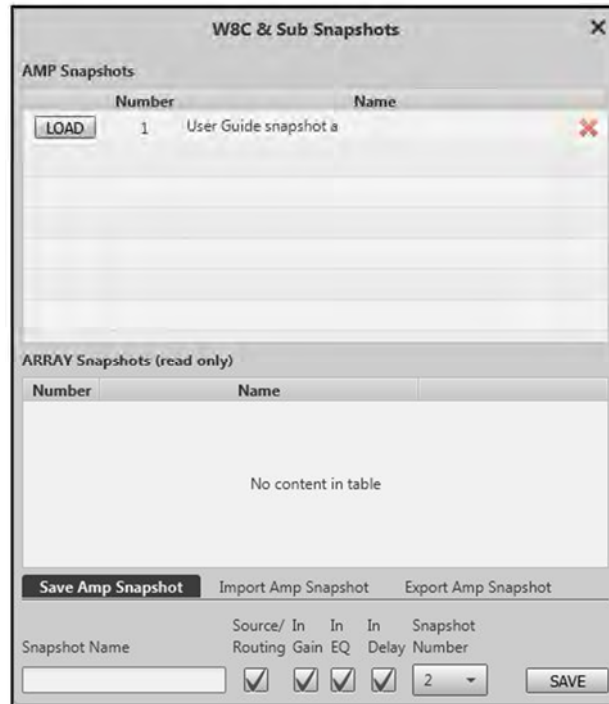

It is also possible to Import and Export Snapshots to a file on your PC to build a library of snapshots. This is particularly useful if you need to save more than the 20 maximum that can be stored in the amplifier. To change to *Export Snapshot* use the option in the row towards the bottom of the Snapshot window; -



By default, Save Amp Snapshot is selected. If we click on Export Amp Snapshot it will be highlighted and the bottom of the window changes; -

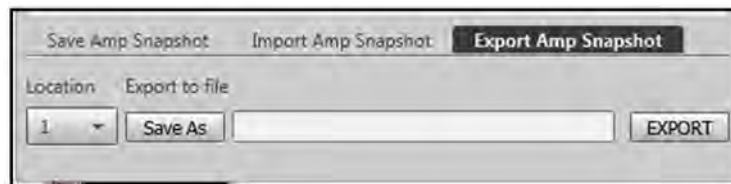

The first step is to select the snapshot you wish to export from the list available in the amplifier using the drop-down **Location** box. In the example above there are two available. Next click on **Save As** and navigate to a suitable location on your hard drive. Give the file a suitable name and click Save. Note that the file name is independent from the snapshot name. The Export section appears as follows; -

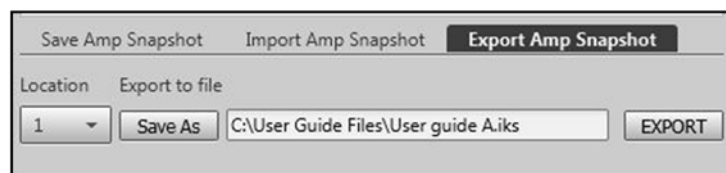

Finally click EXPORT and the file will be created and uploaded to your PC.

To Import a file, click on the Import Amp Snapshot tab; -

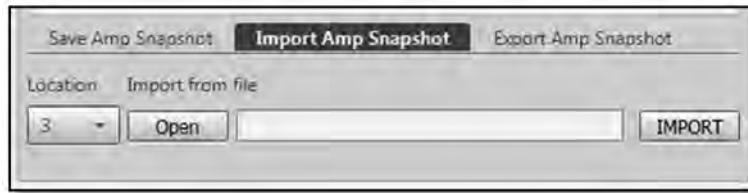

First select the Snapshot location into which you would like to store the file. It will default to the next free snapshot location but you can select a location that is already populated and the settings will be over-written with the parameters in the new snapshot;

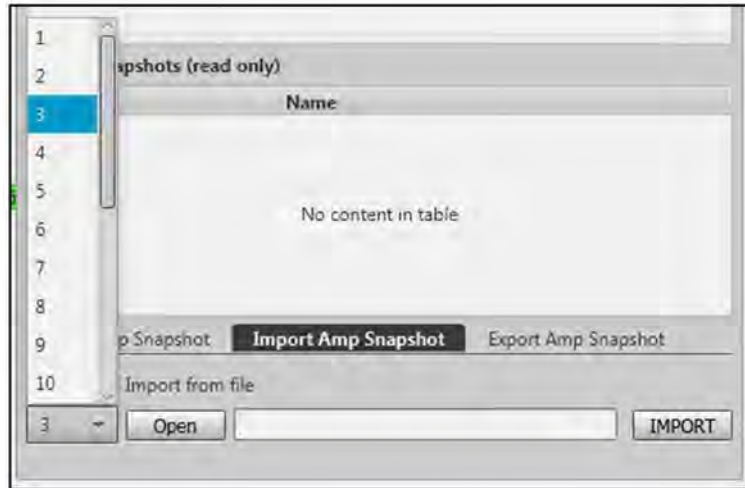

Next click **Open** and navigate to the file location on your PC where you have stored your snapshot file collection. Select the file you need and click **Open**;



Now click **IMPORT** and the Snapshot will be stored to the amplifier and will appear in the Amp snapshot list;



This can be loaded at any time as required. Any snapshot can be deleted by clicking on the Delete X on the right side of the window;



### Array Snapshots

Array snapshots give you the option to store a snapshot which includes all channels used in an array including arrays that may include multiple DX4.0. It will also store an array snapshot that may not use all of a processor's channels, ignoring the remaining channels. This is useful for comparing optimisations for an installation. A number of optimisations can be tried using Display 2.3, they can be uploaded to the DX4.0(s) and each version stored as an array snapshot. These can be very quickly recalled to compare to find which gives the best results in the venue.

Note that each DX4.0 has 20 snapshot locations in total which can be *either* amplifier snapshots or array snapshots.

In the example we have a rack of two DX4.0 driving a single 16 module O-Line array at 1-box resolution. We can store an array snapshot in these processors. Click on **ARRAY SNAPSHOTS**; -

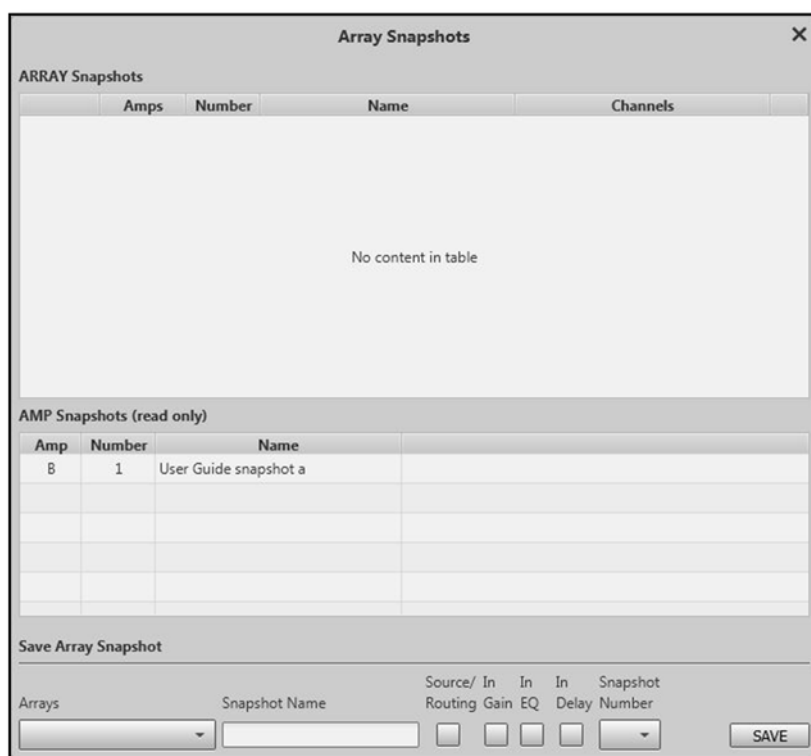

The top section shows all existing Array Snapshots, in this example there are none.

The lower section shows all Amplifier snapshots. In this example, Processor A has the User Guide snapshot for W8C.

To store an array snapshot, click on **Arrays** at the bottom and use the drop-down to select which of the arrays in your project you wish to save by clicking in the check box; -

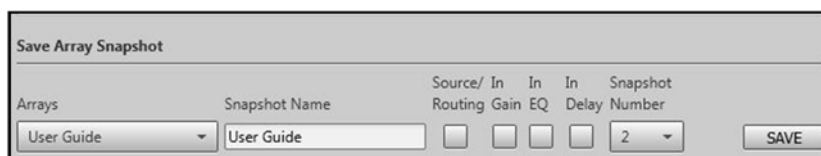

The snapshot name will default to the array optimisation name, but you can give it an alternative name by over-typing in the Snapshot Name window. Select which of the input parameters you would like to include in the snapshot, you can click on

Source/routing, Input gain, Input EQ and Input delay independently. Use the Snapshot Number drop-down to select a snapshot location. This will default to the next snapshot location that is clear on all DX4.0 driving the array. In this example as DX4.0 B has a snapshot in location 1 the next available location is 2; -

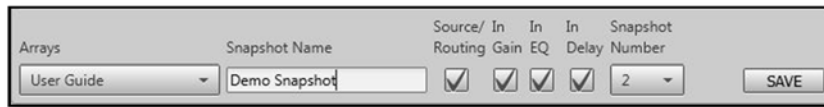

Click **SAVE** and the array snapshot is stored and appears in the list in the upper section of the array snapshot window; -

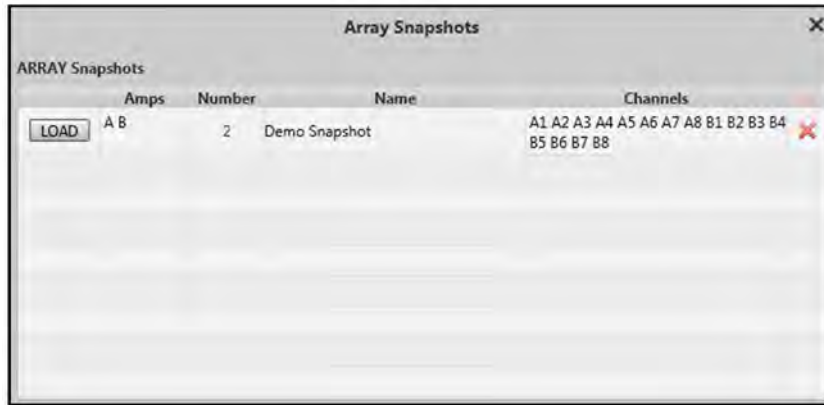

If we take a look at the Standard snapshots for the two DX4.0 we can see how the Array snapshots are displayed along with the amp snapshots; -

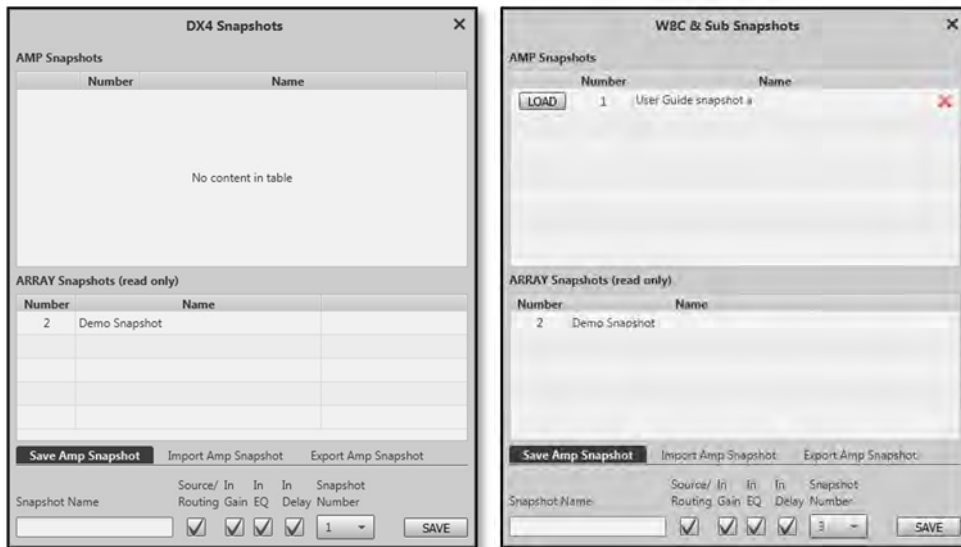

The top section shows the amp snapshots in each DX4.0. The array snapshot appears in the read only window to show that the location (2 in this example) has been used and is no longer available. Note that when saving a new amp snapshot you cannot overwrite an array snapshot, to use the location which has been used for an array snapshot it is necessary to delete the whole array snapshot from the Array Snapshot window using the delete button; -



## iK81 & iK42

The iKon amplifiers are primarily designed to run both the Wavefront Precision Systems and the XE Series stage monitors. They can also be used to drive any other Martin Audio products with presets available to directly load the correct parameters in the channels of your choice. You can also freely configure the amplifier to run any other system editing the parameters and routing via Vu-Net and storing them internally in the amplifiers.

Amplifiers are added to the Project either by dragging from the Palette in off-line mode or using device discovery when on-line. Off-line mode is useful only for getting familiar with editing amplifier parameters within Vu-Net. You cannot create an off-line project and upload to amplifiers, as the Vu-Net environment depends on individual IP address for every device, you have to perform a Device Discovery to find devices that can be used in a project.

With the network established click on Discover Devices on the toolbar; -



Here we have a single iK42 and iK81 on the network which have been discovered; -

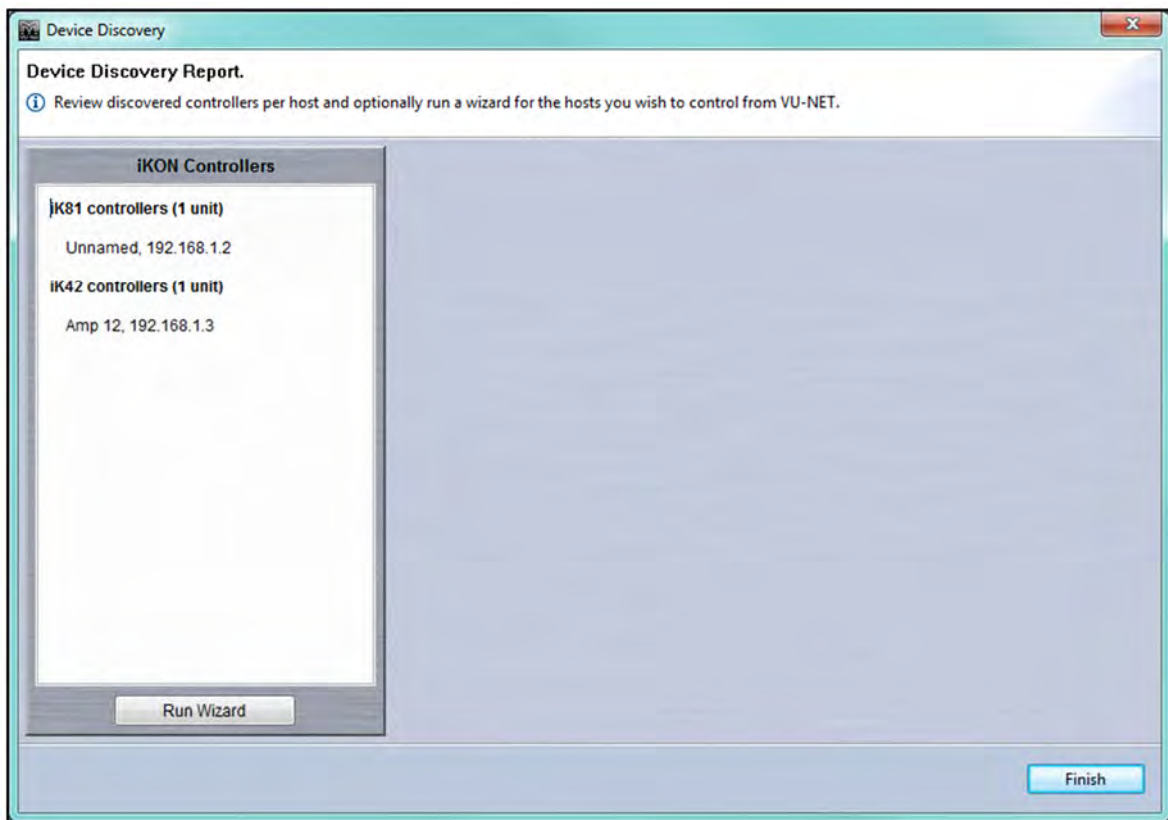

Click on Run Wizard and the Synchronisation will run which ensures that any parameters within the amplifiers are uploaded to Vu-Net so they are visible on your PC; -

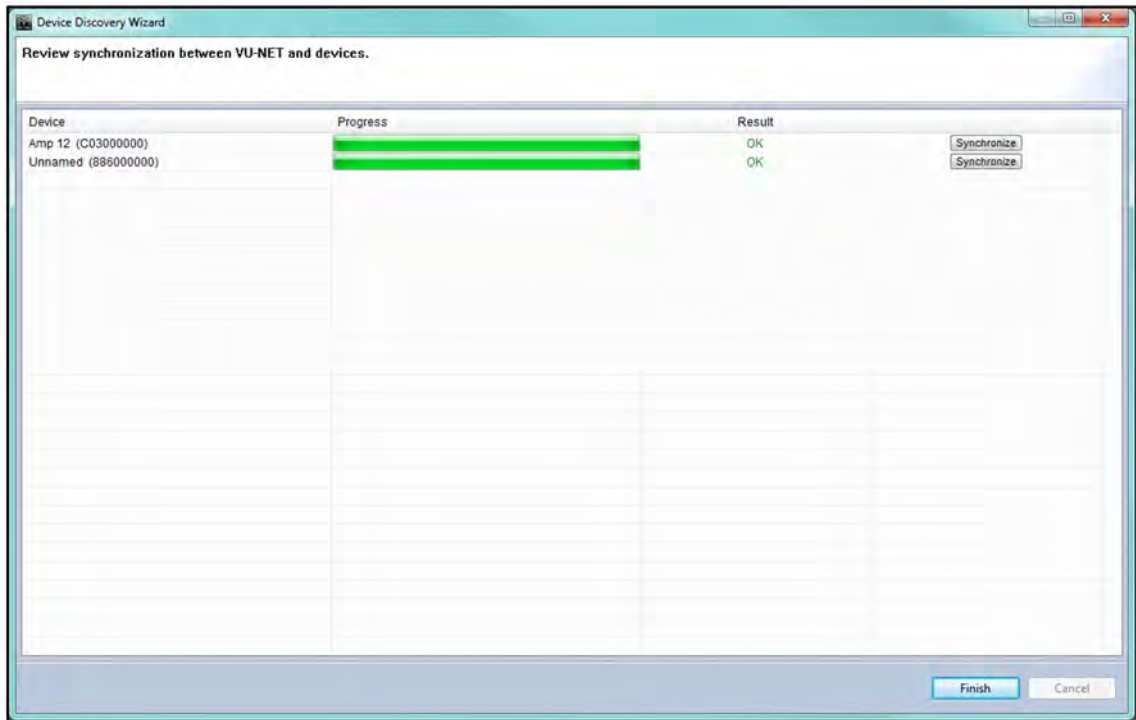

Click on Finish to close the Synchronisation window, then Finish to close the Discovery window. The amplifiers will now be displayed on the System diagram; -

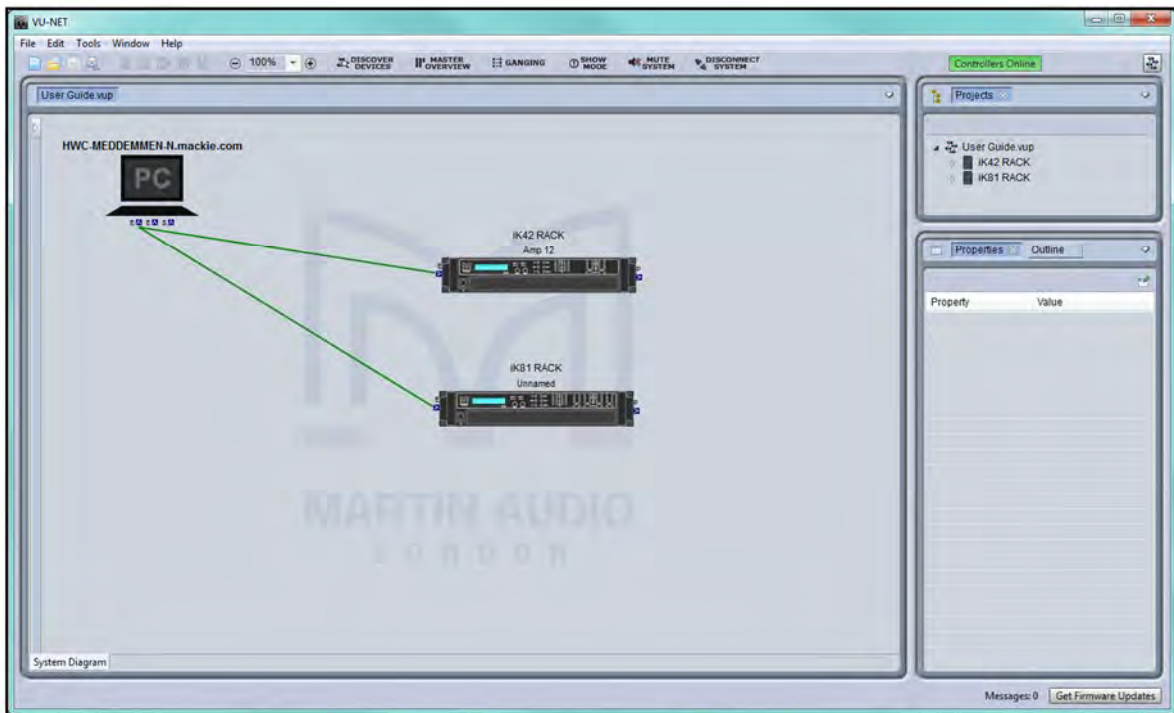

Amplifiers are assigned to racks according to their type so all iK42s will be shown on one rack, and all iK81s in another.

### Right Click

The right click menu for the iKon amplifiers is a little different from other Vu-Net enabled products and has one particularly important function. This is the right-click menu; -



### Open

This has exactly the same effect as double clicking on the amplifier thumbnail to open the editing window for all of the amplifier parameters.

### Open Preset Manager

This opens the Preset Manager Window; -

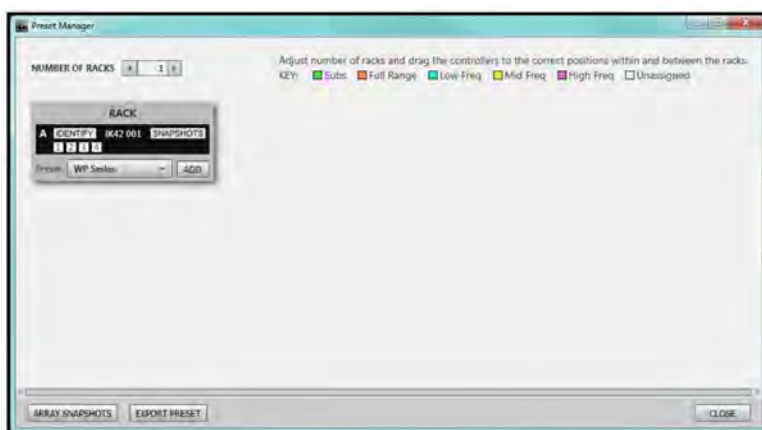

Preset Manager is where the amplifiers in the Project are arranged into racks and Presets are loaded (Preset Loader in the 'Tools' menu is not used with the amplifiers). Presets may be d2p files created for O-Line, WPM, WPS, WPC or WPL, or fixed parameter presets for XE monitors, BlacklineX or other systems.

See the *Preset Manager Chapter*.

### Reset to defaults

This allows you to reset the amplifier to default settings which can save a great deal of time when configuring an amplifier which has been used on a previous job and has a large number of settings edited. As this is a highly destructive command the following windows will appear prompting you to confirm the action; -



If you definitely want to reset the amplifier click **OK**, otherwise click **Cancel**.

### Synchronise

This will synchronise the settings in Vu-Net with those in the actual amplifier. This may be necessary if there has been a loss of the network connection or a change has been made to the amplifier via the front panel controls.

### Disconnect/Reconnect

This allows you to disconnect individual amplifiers from the network without having to disconnect the entire system from the network. The same button is used to reconnect an amplifier which has been disconnected.

### Rename

This allows you to give the amplifier a name of your choice up to a maximum of 30 characters. With the amplifier selected, the keyboard shortcut is F2.

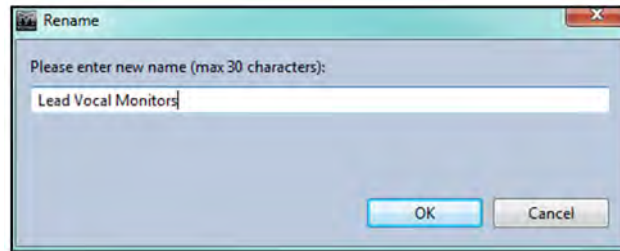

### Select All

This will select all devices in the project.

### Delete

Will remove the amplifier from the project. A window will request that you confirm the Delete; -



Click OK to delete the amplifier or Cancel to return to the screen

### Gain Mute & Limiters

Double clicking (or right-clicking and selecting 'Open') will open the amplifier DSP window. The default page is the Gain, Mute and Limiter page (Note that all pictures will show an iK81. An iK42 is exactly the same but with 4 output channels instead of 8). To switch between the DSP windows, use the tabs in the bottom left of the screen; -



The gain page appears like this; -



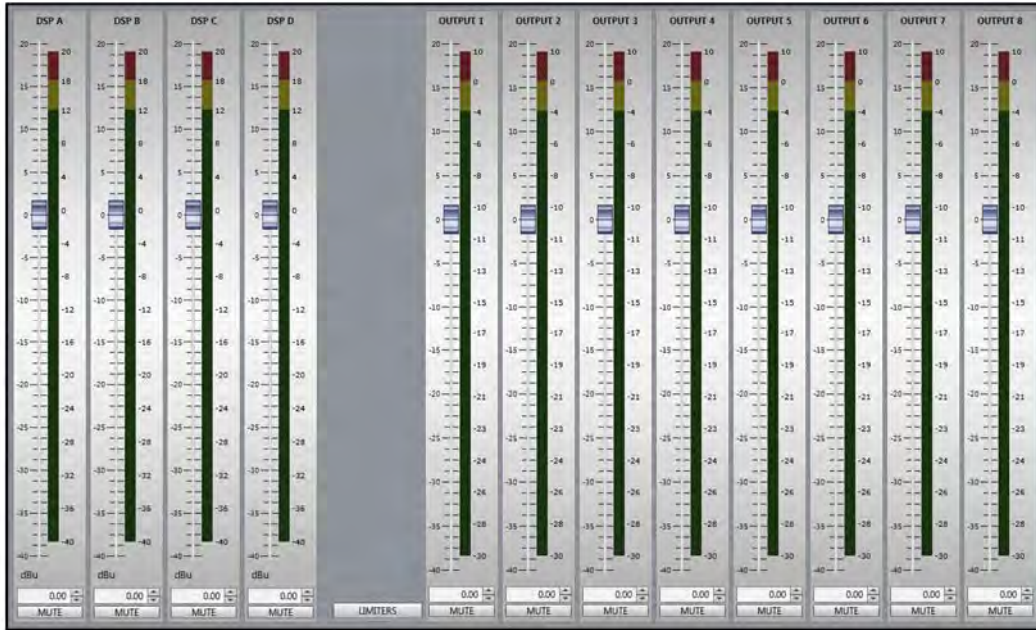

This is an iK81, an iK42 appears as follows; -

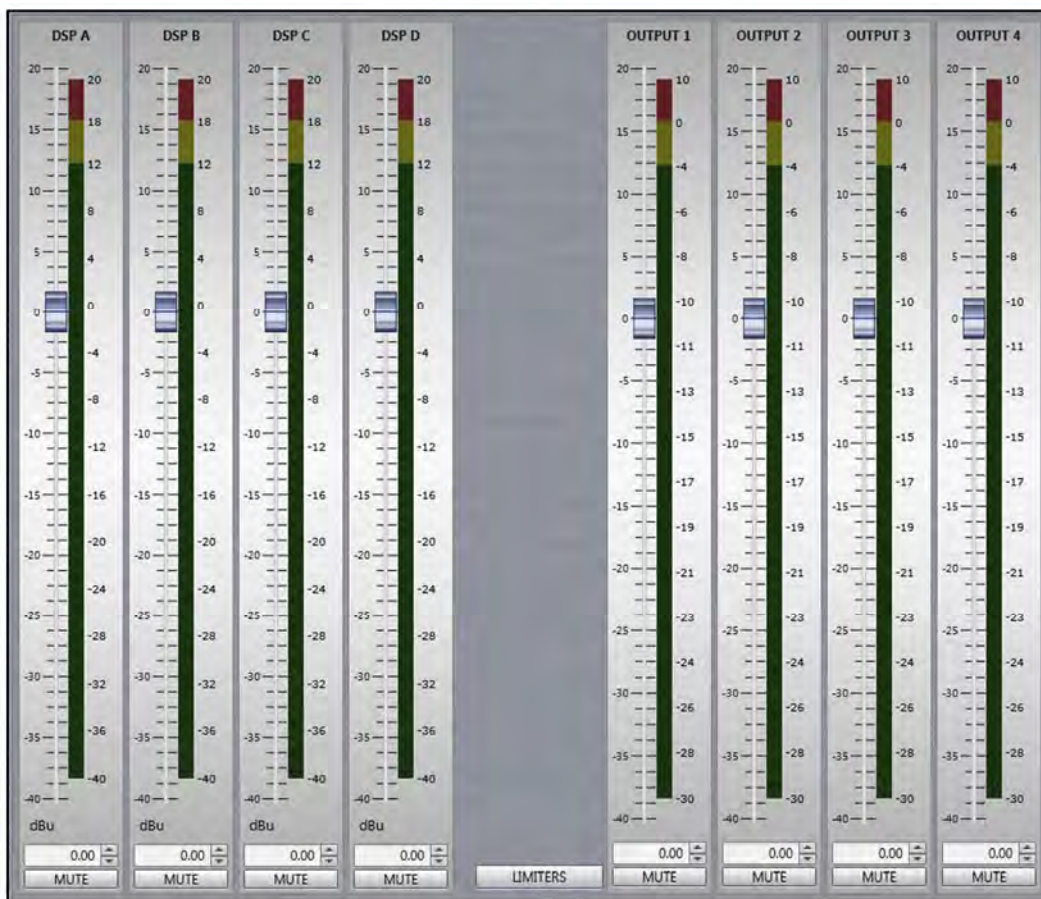

All inputs and outputs have a gain control offering gain adjustment of up to +20dB and -40dB. Gain can be adjusted in three ways; by clicking and dragging one of the faders, releasing when the required gain is reached. The gain that has been set is displayed in the window below the fader; -

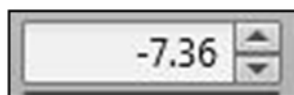

The value displayed can be directly overwritten to enter a precise gain as required. Double click on the number which will highlight it, then type the required value. The final way to adjust gain is using the up/down arrows to the right of the value. This will step the gain up or down in increments specified in the Vu-Net Preferences. By default this is 0.5dB but it can be changed to 1, 0.5, 0.25, 0.2 or 0.1dB steps.

To the right of the fader is a bargraph meter which will show level in real time. The input meters are calibrated from +20dBu to -40dBu, 20dBu is the maximum input level before the input of the amplifier will clip.

The output meters behave in a different manor to the input. These display the output level in relation to the limiter settings. They are calibrated from +10 to -30dB. The yellow segment between -4dB and 0 indicates that the limiter threshold has been reached. Above this from 0 to 10dB indicates that the limiter is active.

Below all input and output faders is a mute switch; -



This will turn red when clicked to show the input our output is muted; -



Between the input and output sections there is a button labelled 'Limiters'; -



This will open the output limiter functions (iK42 shown); -

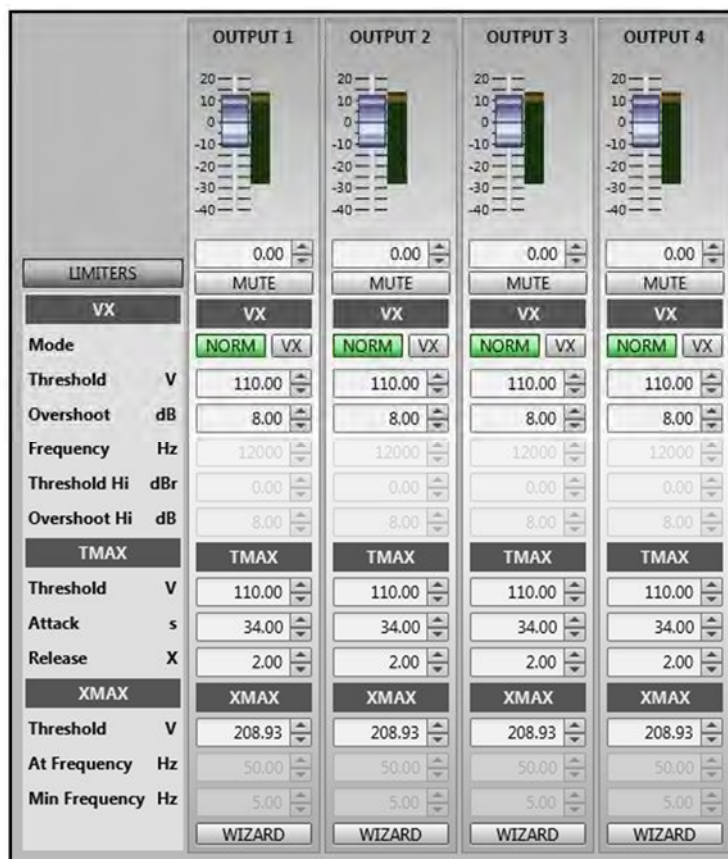

Here are three limiter sections to offer the most comprehensive protection for your speaker system.

### VX

VX is a peak limiter. In normal mode the active parameters are Threshold in volts and Overshoot in dB. Overshoot prevents the signal from exceeding threshold during the attack phase of the main limiter by more than a predetermined amount. The optimal Overshoot setting is usually about 8dB. Lower Overshoot settings will sound progressively 'harder'.

When VX mode is active the VX button turns green; -



You can choose the crossover point of a 'virtual crossover', which incorporates two limiters per output so the user can individually limit the drivers in a passive 2-way enclosure using individual thresholds, and optimised attack and release characteristics for each. 'Frequency' sets the crossover point for the two limiters. The Threshold of the second 'Hi' limiter is set relative to the threshold of the first 'Lo' limiter.

### Tmax

Tmax is a thermal limiter designed to protect the drivers from damage caused by long-term exposure to excessive power beyond the AES rating of the driver. The threshold should be based on the drivers AES rating with the attack and release figures calculated from the voice coil diameter and the frequency band it is running.

### Xmax

The Xmax limiter protects against excessive excursion in the driver. As the magnitude of excursion is generally inversely related to frequency- i.e. the lower the frequency the greater the excursion likely to be experienced- the Xmax limiter is progressively more sensitive at lower frequencies and, rather than varying the gain to provide the limiting action, it uses a sliding high-pass filter to progressively curtail the low-frequency response, effectively limiting the linear excursion to below the X-max specification of the driver. Threshold is entered in Volts. Frequency sets the point at which the threshold voltage is appropriate.

Min Frequency sets the minimum frequency below which the limiter action will level off. For most applications this can be left set to 5Hz.

**Wizard**

At the bottom of the limiter window is the Limiter wizard button. Clicking on this brings up the Wizard window; -



The Wizard allows you to quickly set the optimum limiter settings for a speaker system. You simply select the type of speaker from the drop-down; Sub/LF/FR, MF, MF + HF, or HF. Enter the nominal impedance in Ohms, the voice coil diameter, the number of speakers per channel, the amplifier gain (by default this is 32dB which is the supplied gain setting for Ikon and for the vast majority of professional amplifiers), the Amplifier continuous power at 4 ohms, this will show 1250W on an iK81 as shown above, or 3000W on an iK42. Then click **Apply** and the limiter on that channel will be populated with the best settings to seamlessly protect the speaker.

**Routing**

The routing page allows the inputs and outputs to be routed as required, this differs between the iK42 and iK81. This is the iK42;

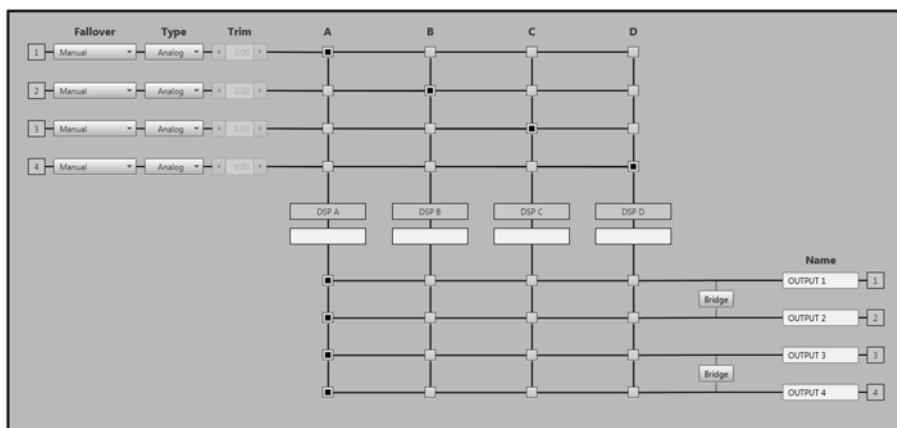

And this is the iK81; -

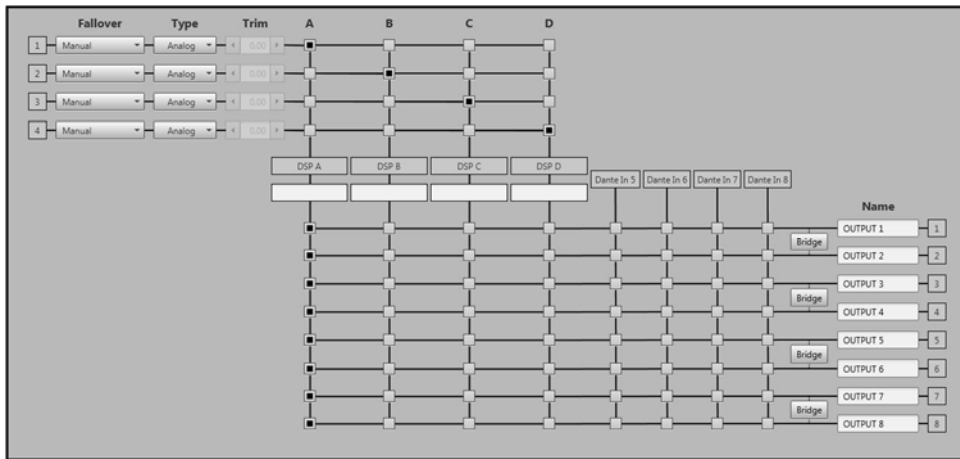

**Input Routing Matrix**

The routing matrix allows any input to be assigned to any DSP and the DSP outputs to be assigned to any amplifier output. In standard mode each input is routed to one DSP; Input 1 to DSP A, Input 2 to DSP B and so on. This is mode is suitable for the vast majority of applications however any signal path that may be required can be selected; -

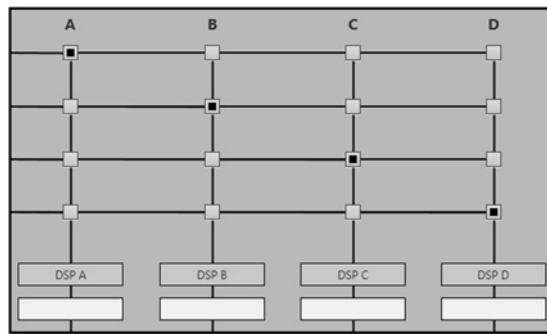

**Output Routing matrix**

The output routing matrix allows the signal feed to the amplifier outputs to be routed from one of the input DSP, or in the case of the iK81, each output can also be routed from Dante inputs 5 to 8 giving the amplifier 8 channel capability when used with a Dante feed. This is the iK42 matrix; -

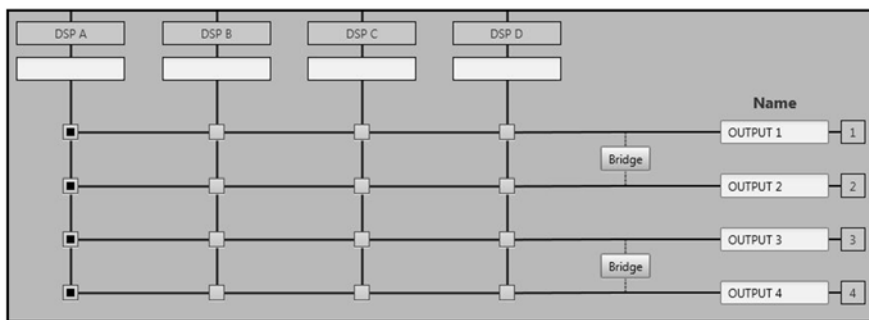

This is the iK81; -

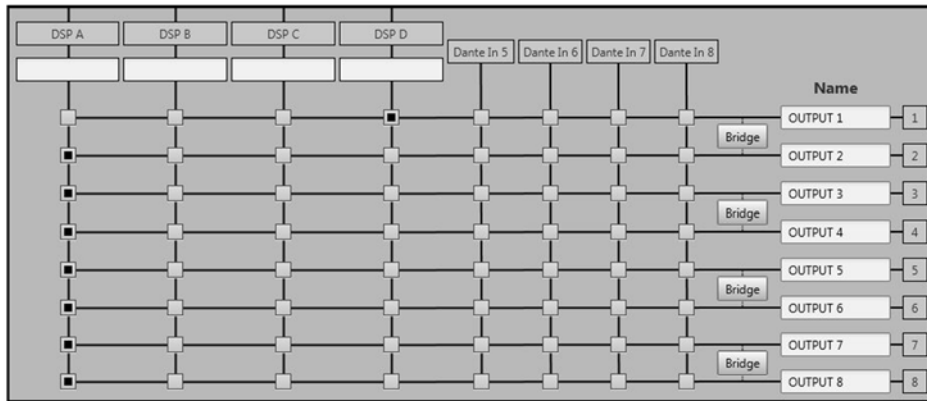

Note that only one signal can be routed to each amplifier output, you cannot sum several outputs from the input DSP or Dante 5-8 (ik81 only) to an amplifier output.

### Names

DSP and Amplifier outputs can be re-named by clicking on the name window and simply typing the name you require up to a maximum of 12 characters.

### Input Type

The amplifier inputs by default are set to Analogue. The drop-down allows a choice of no input, Analogue, AES3 (inputs 1 & 2 only) or Dante; -

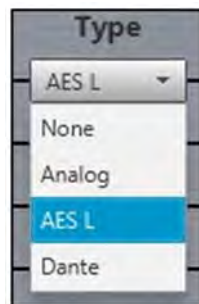

Input 1 can be fed from AES L and Input 2 from AES R.

### Fallover

When either AES3 or Dante are selected you have the option to select a fallower mode to select an alternative input type in the event of your original choice failing; -

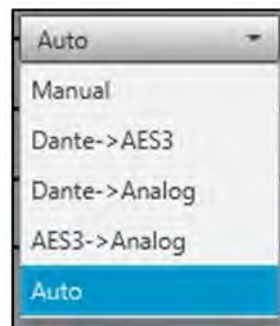

By default this is set to **Manual** meaning you will need to manually select an alternative input. **Dante- > AES3** will select the AES3 input in the event of the Dante stream failing. **Dante- > Analog** will revert to the Analogue input should the Dante stream fail. **AES3- > Analog** will switch the input to Analogue should the AES3 feed fail. **Auto** will revert to the highest priority input that is active, in order the priorities are; Dante, AES3, Analogue.

### Trim

The trim option appears when Dante or AES3 are selected as the input mode. As there is no standard for relative gain between analogue and digital protocols, this allows the gain to be adjusted to match the analogue input so should you need to switch inputs, either manually or automatically using one of the Fallover modes, there will be no jump in level. Gain adjustment of up to +20 and -40dB is available.

### Bridge

Outputs may be run in bridge mode pairing adjacent channels by clicking on the Bridge button which will change to green when bridge mode is enabled; -



In this mode the lower, odd numbered channel takes control, any parameters that require editing will need to be done on this channel with the even number output channel functions disabled (they are not visible in the Output channel EQ pages for example, only the odd number channel is shown for any bridged pairs).

### Input Channels

The input Channel tab appears like this; -



This allows adjustment of all EQ and shares its format with Equalisation windows in all other Vu-Net devices. The channel to be adjusted is selected using the buttons at the top left of the screen; -



EQ bands are adjusted by moving the cursor over them, clicking once which selects the band and they can then be dragged to change the frequency and gain.

Filter bands can also be selected by clicking on the Filter buttons above the graph; -

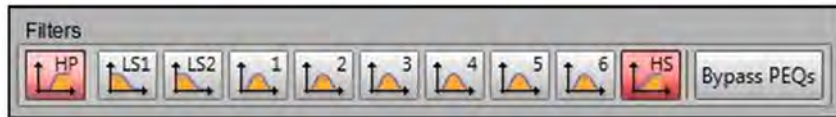

Selected filters have a blue button, any filters that have a gain setting other than 0 (i.e. they have been adjusted) will have green buttons. Bypassed channels will be red. Note that by default the Hi Shelf filter is bypassed as this is an FIR filter and adds to the latency significantly; -

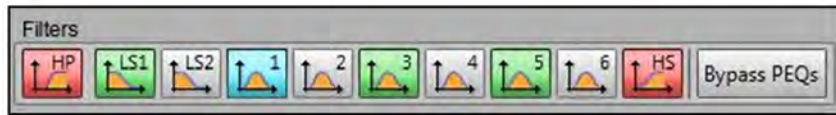

All channels can be bypassed by clicking on the Bypass PEQs button which turns all buttons red; -



This is a temporary bypass which can be reversed with a second click on the Bypass PEQ button. All previous PEQ settings will be restored.

The overall equalisation shape is shown with a white trace, the response for the selected band is shown in red. This shows EQ band 8 selected; -

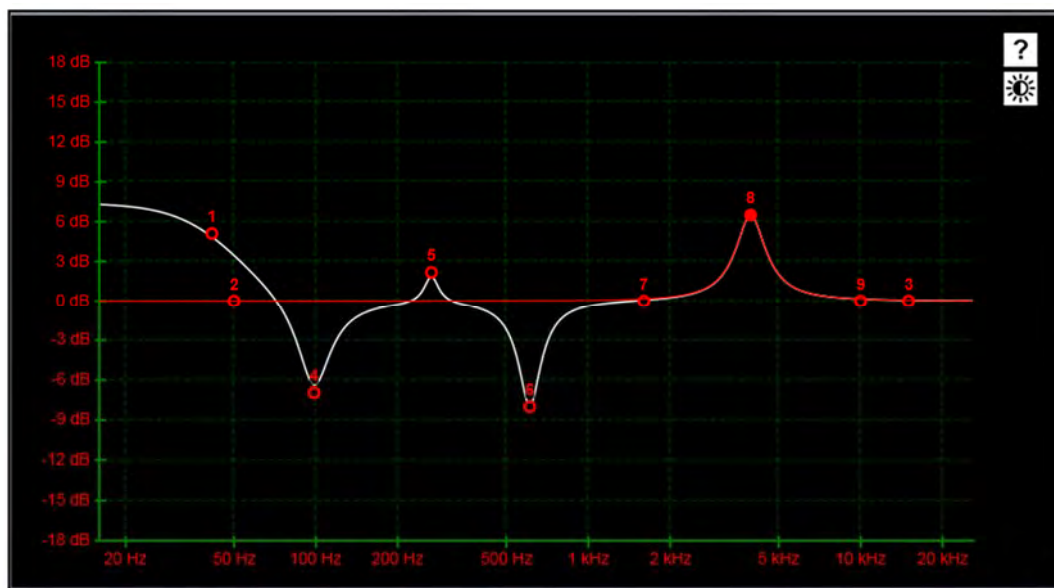

**Show All** will display the curves of all four channels simultaneously; -



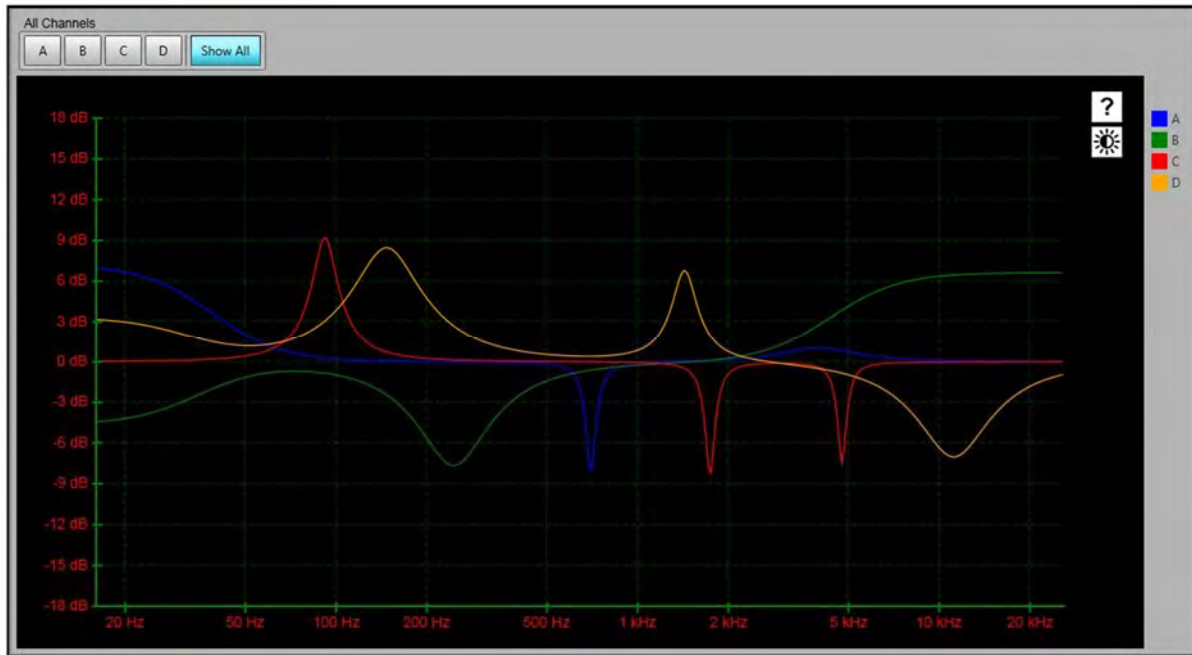

The key to the trace colours as displayed on the right are; -

- Blue Channel A
- Green Channel B
- Red Channel C
- Yellow Channel D

There are two icons in the top right corner to assist with using the EQ graph. The First; -



Is a help function which brings up the following window; -

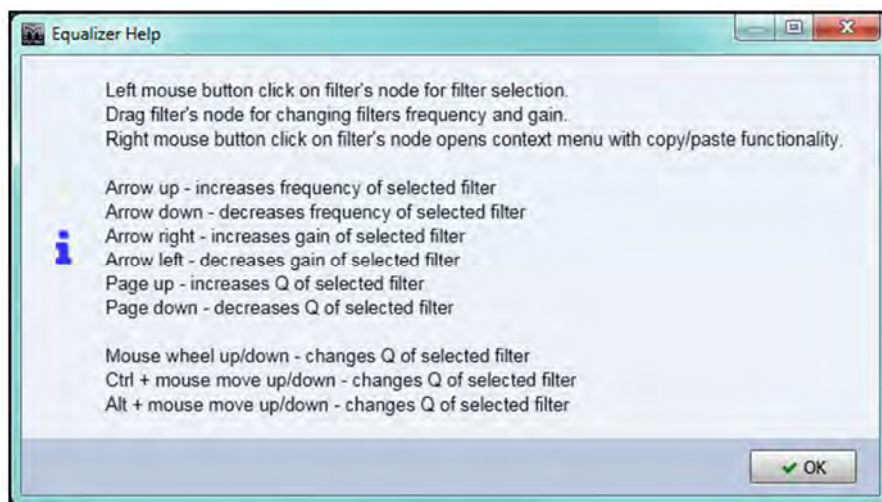

This shows how to change settings in the EQ graphical window using keyboard shortcuts.

The second symbol; -



Changes the display mode to daylight operation for when using Vu-net in bright conditions such as outdoors when configuring a festival system. The EQ view will reverse and appear like this; -



As shown in the help window, there is a copy and paste function available by selecting an EQ band and right-clicking; -

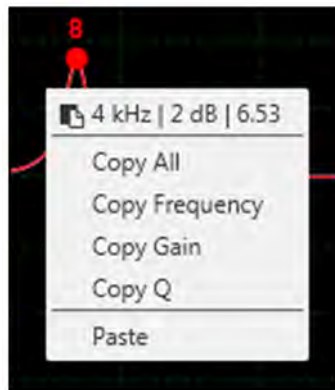

At the top is a summary of the selected EQ showing its frequency, gain and Q Factor. You can choose to copy all three filter parameters, just the frequency, the gain or the Q. You can then click on any other filter in any of the inputs or outputs and right click selecting Paste to transfer the parameters.

The section on the right offers a precise method for adjusting EQ parameters. This section will be active for whichever filter band is selected. This is showing the parameters for channel A band 8; -

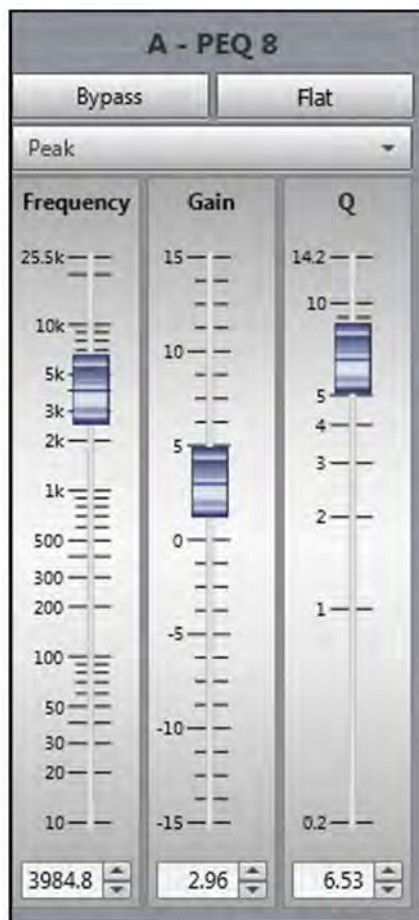

At the top is a Bypass button. This will retain the parameters set for the EQ band selected so they are not lost but will bypass the equalisation. When bypassed the bypass switch turns red and the parameter controls are greyed out; -

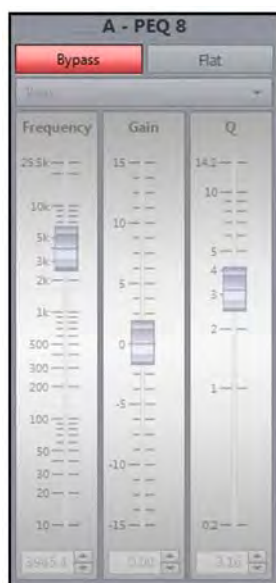

No changes can be made to the filter while it is bypassed. The graphical view will change accordingly; -

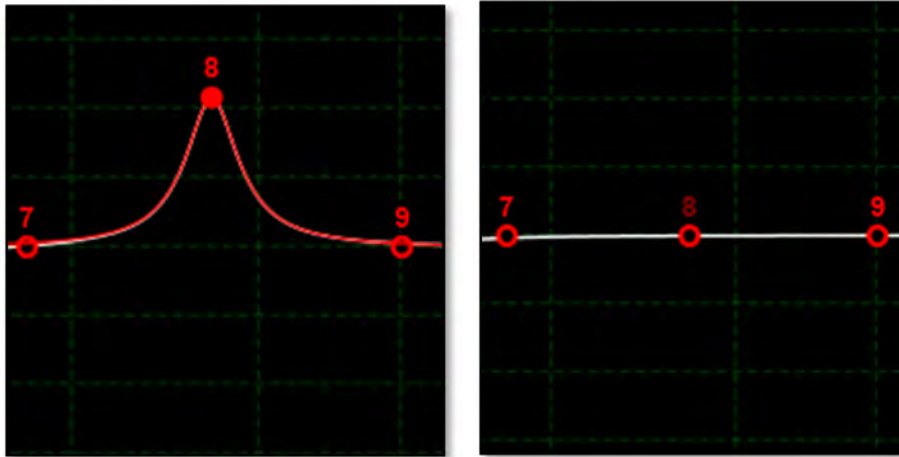

The EQ trace flattens and the band number greys out.

The Filters buttons at the top of the graph will show the bypassed EQ with its button in red; -



Next to the Bypass button is 'Flat'. As you might expect this zeros the gain of the selected band. It is "destructive" meaning once flattened you cannot return to the previous value although the frequency and Q values are not affected.

Below the Bypass and Flat buttons is a display showing the filter type; -

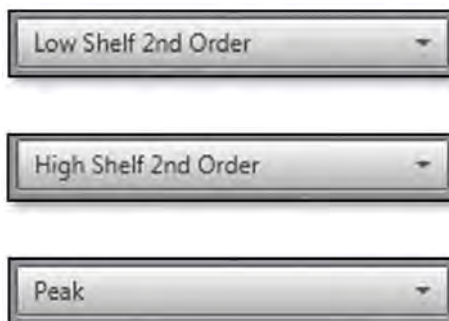

The High Pass filter has options for Bessel, Butterworth and Linkwitz-Riley; -

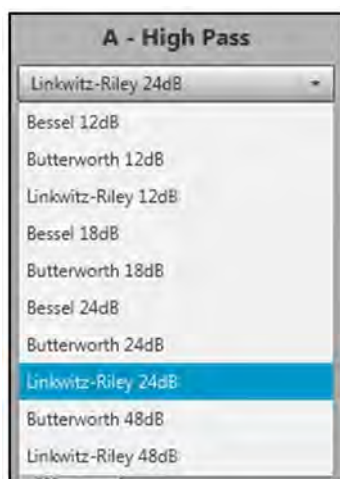

The first filter is the Highpass, There are two 2nd order Low shelf, Bands 1 to 6 are parametric ("Peak") filters by default and the final filter is a 2<sup>nd</sup> order high shelf.

The three faders for Frequency, Gain and Q can be adjusted in three ways for precise control of these parameters. First you can click on the fader knob and drag it to the required position to adjust the value. The value displayed in the box below the fader will adjust in real time.

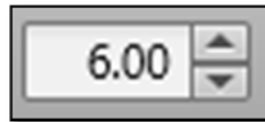

You can also use the up and down arrows to adjust the value, the increments are set in the Vu-Net preferences. By default the gain will increase or decrease in 0.5dB steps. Finally, you can click on the value and directly type exactly the value you need.

## Output Channels

The output channel tab is almost identical to the input channels; -



The channel being viewed is selected by the Channel buttons top left. This is an iK81; -



This is an iK42; -



The filter band is selected using the filter buttons or by clicking on the filter in the graph; -

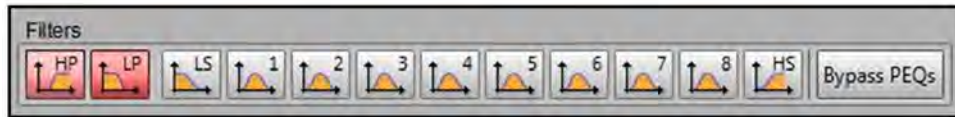

There are high and low pass filters. A low shelf plus 10 bands of parametric or All Pass EQ.

As with the Input EQ, filter gain and frequency can easily be edited directly in the equalisation graph by clicking on the numbered dot representing each filter band and dragging it to the required position. There are keyboard shortcuts as for the input EQ; -

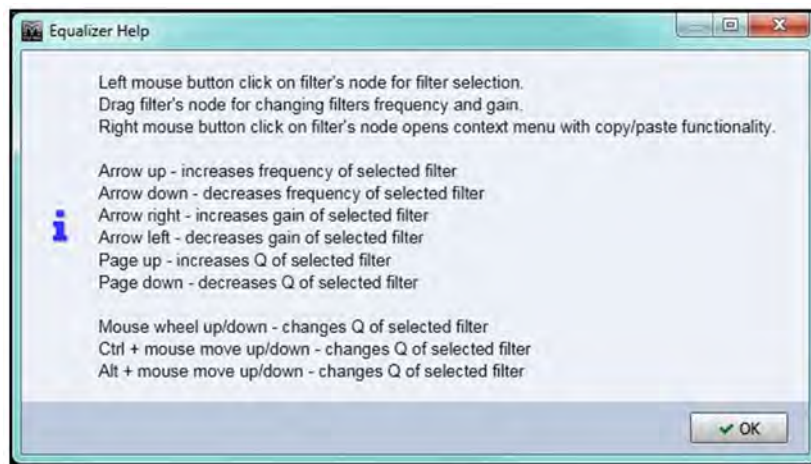

And you can also select daylight mode; -

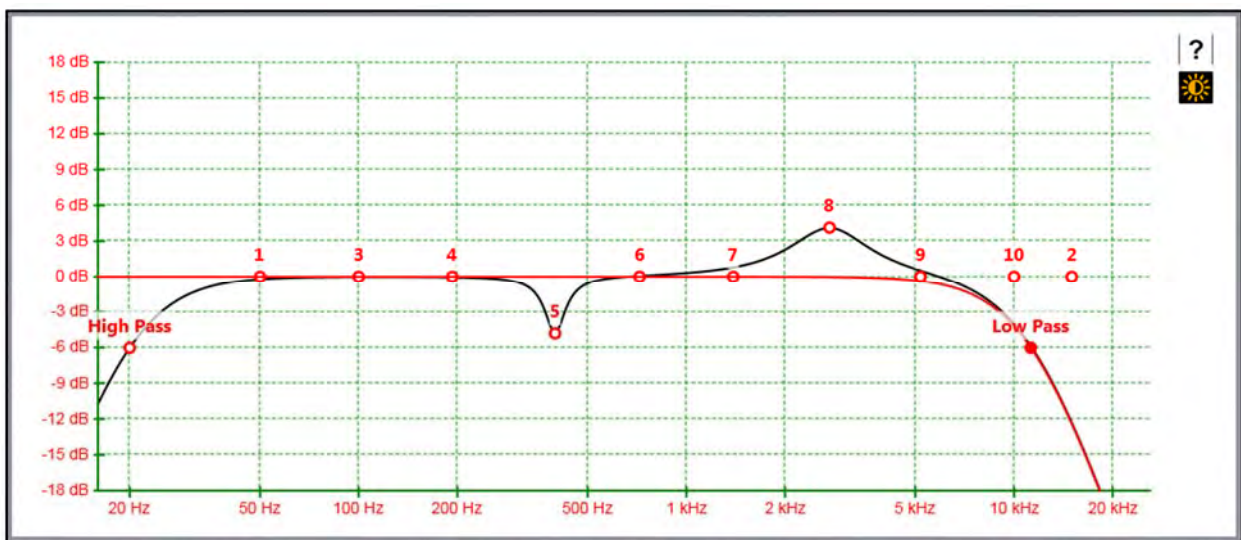

Also identical to the input EQ is the facility to directly edit values for a selected EQ filter using the panel on the right; -

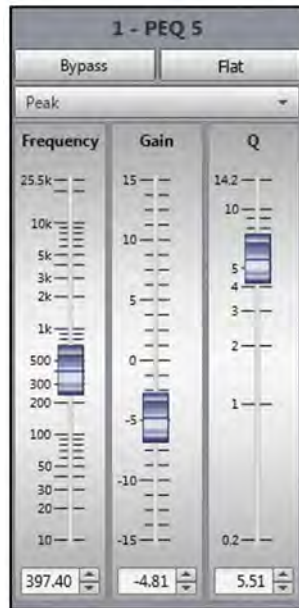

The Parametric filters 1 to 10 operate in exactly the same way as those in the input EQ and values can be copied and pasted between them if required using a right click with the cursor over the band you wish to copy from and paste to.

In addition, output PEQs can be changed to All Pass filters using the drop-down box; -

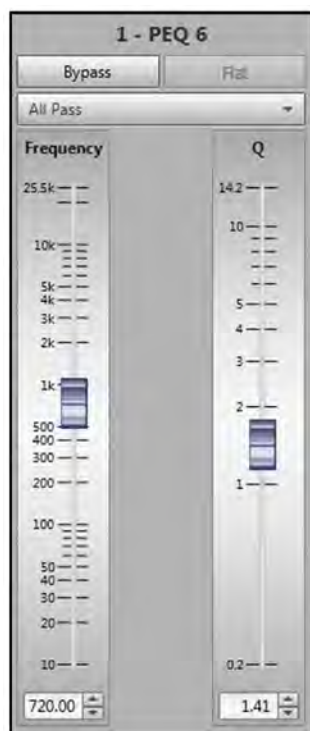

Note that there is no graphical representation of an active All Pass filter as it effects phase only, there is no change to the frequency response so the graph isn't affected. The button for that filter band changes with a thumbnail representation of All pass; -



In addition, the filter graph shows All Pass filters with a blue dot; -



The high and lowpass filters are both active by default. The filter type for each can be selected from the drop-down box above the Frequency fader; -

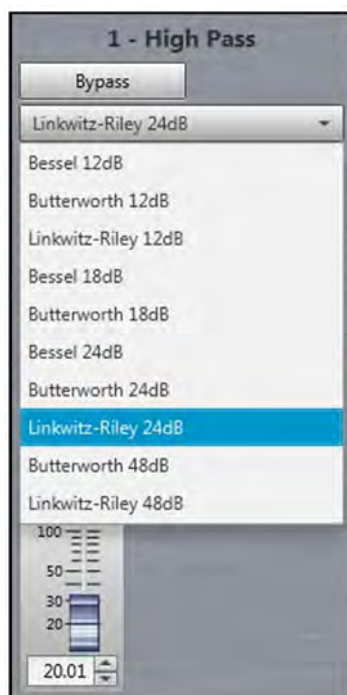

### Delay

The delay tab is similar to the routing page and looks like this; -



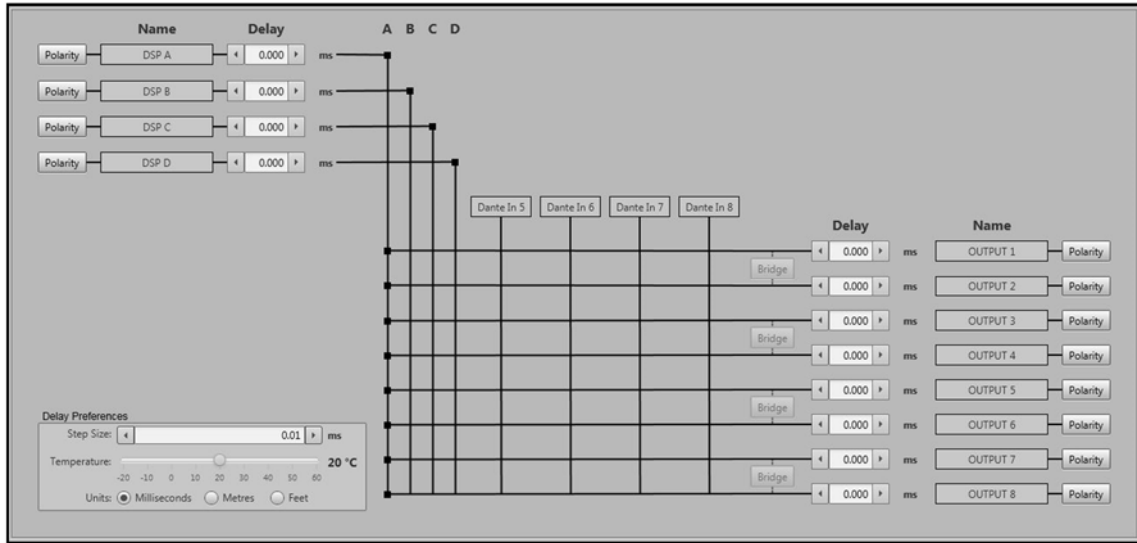

There are three sections to the window. The input delays including polarity; -

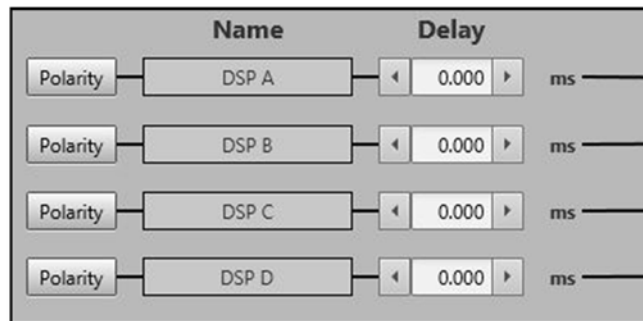

Output delays (ik81 shown); -

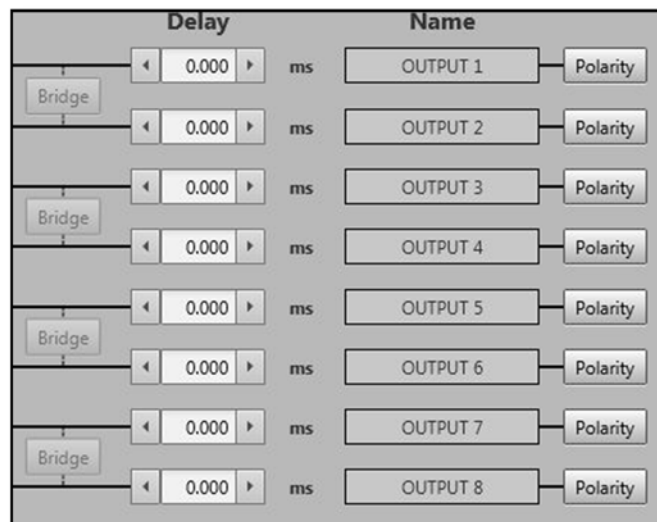

The input Delay and output delays are connected with a representation of the routing that has been specified in the routing tab.

The final section is the delay Preferences; -

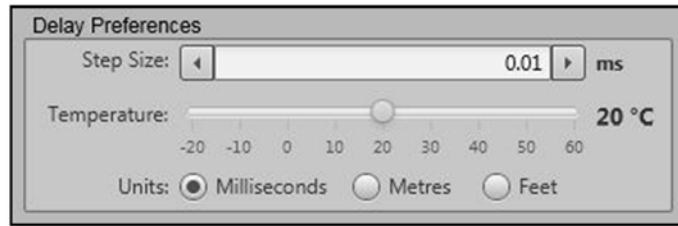

First it is worth looking at the Delay Preferences. Step Size determines the increments that the delay will increase or decrease if the up/down arrows are used for adjustment. This ranges from 0.01 to 100 milliseconds. Units: selects the measurement units displayed for delay which can be either Milliseconds, Meters or Feet. Temperature is used to enter the room temperature when delay figures are entered, should the temperature change you can move the temperature slider to the new reading and delay values will automatically update to compensate for the different speeds at which sound travels through air depending on temperature.

Input and Output delays operate in identical fashion, delay can be either directly entered- any value from 0 to 998ms, or a starting value can be entered and you can use the arrows either side of the value window to adjust the value in steps. The size of step is set in the Delay Preferences section.

The final feature on the delay tab is Polarity. This reverses the polarity on the output changing the button colour to green; -



## Ganging

The ganging is an extremely powerful yet simple tool to ensure that parameters are linked. Ganging is handled in a floating window which is opened by clicking on the ganging button on the toolbar; -



In a project with two iK81s and two iK42s, the ganging window appears like this; -

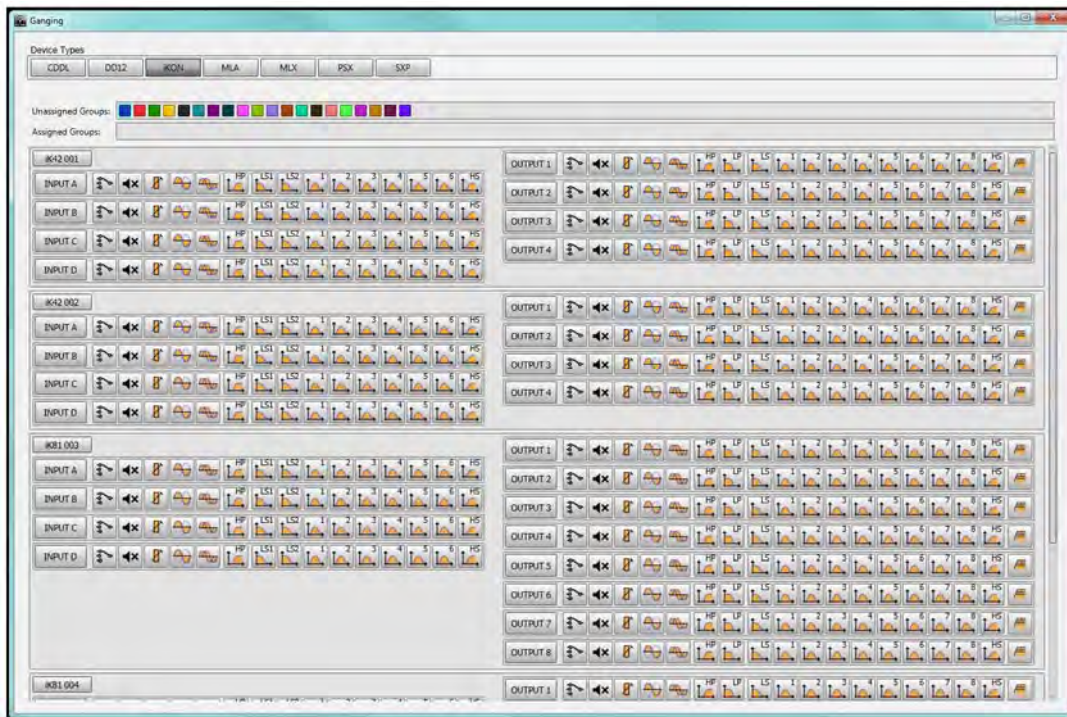

All iKon amplifiers in the project will be shown with an individual button for all of their input and output functions. These can be ganged in several ways. First we can gang entire amplifiers together. In this project we have two iK81s both driving LE200's, we can gang both amplifiers together so that any changes to one will be matched in the second. The first step of any ganging procedure is to select a group. There are twenty of these represented by different colours and with no gangs set, all 20 will be unassigned; -



The next available gang is always highlighted so unless we want to use a different colour, we can proceed by clicking on the name of both of the iK81s driving LE200. These are labelled "LE200 A" and "LE200 B" in our project, this is prior to ganging; -

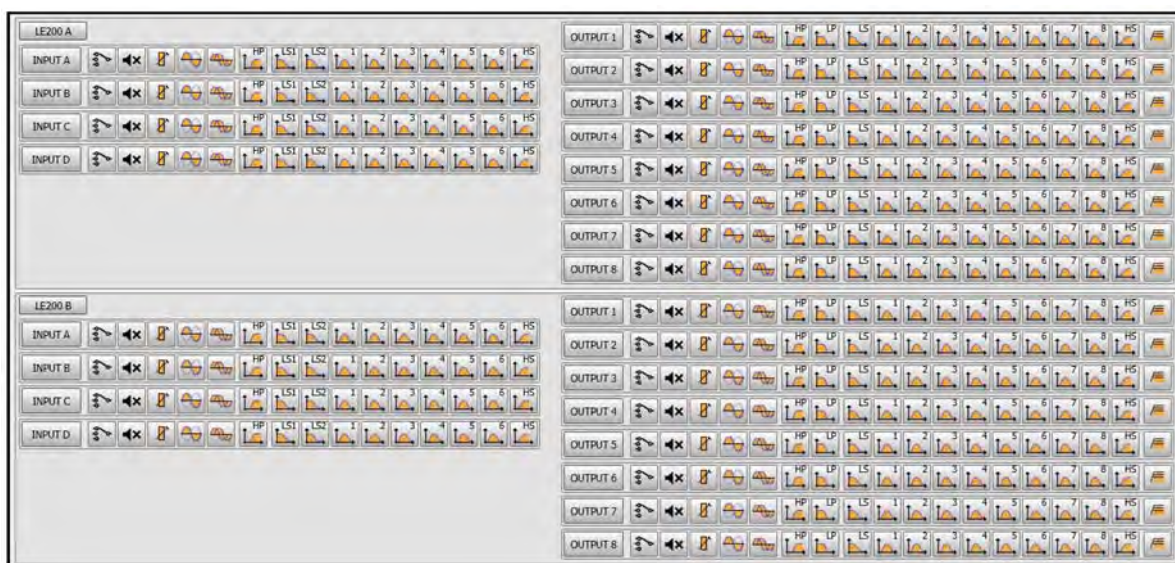

And this is ganged; -



Now any changes on any parameter on "LE200 A" will be matched on "LE200B". Vu-Net has automatically assigned 8 groups to match the number of channels.



There are two important things to note. Although input channels 1 to 4 are in the same ganging group as output channels 1 to 4 this does *not* mean that inputs and outputs are ganged. You can only gang the same parameter types. Secondly, ganging for variable parameters such as gain is always *relative* so if a value already exists on one parameter when that is ganged to another the value remains and any subsequent adjustments will retain the difference between them. For example, if you have two amplifiers one has a gain or +6dB on Channel 1 the other has 0dB on Channel 1. If you gang those parameters, the +6dB remains. If you now increase the gain on either amplifier by say 3dB, the first amplifier will now have a gain or +9dB, the second 3dB. If you were now to *reduce* the gain by 10dB, the first amplifier will have a gain of -1dB, the second will be at -7dB. The 6dB difference between the two will always be retained.

Now back to our amplifiers driving monitors. The ganging we have used is actually not really what we want. It is easily removed by clicking again on the amplifier name button and all the coloured ganging indicators disappear and all ganging groups are unassigned. Now click on the label for Output channel 1, channel 3, channel 5, and channel 7 of both amplifiers. Go to the Unassigned Groups and click on a colour, red is next, and now click on Output channel 2, 4, 6 and 8 on both amplifiers. It now appears like this; -



This makes far more sense for our two amplifiers. All the odd numbered outputs are driving the LF on our bi-amped monitors and all the even numbers are driving the HF. We can enter the parameters on one pair of channels and these will be matched on all of our outputs, thus our monitors are perfectly matched. The input EQ is left un-ganged so we can use it for independent EQ to ring-out and feedback.

This is a great solution however, when we are setting up we may wish to mute and un-mute outputs independently. This is easily achieved just by clicking on the mute button in the ganging page for all outputs; -



This removes them from the gang groups and they will now operate independently whilst all other parameters remain ganged;



As well as entire Inputs and outputs, individual parameters can be grouped in the same way, select an unassigned group and click on all the parameters you wish to be ganged; -



To remove a parameter just click on it again. If you wish to add more parameters to the same group, click on the colour of the group you wish to edit from the Assigned Groups list at the top of the page then click on the parameter button or buttons you wish to add.

Ganging as you can see is a very quick and simple process that makes it very quick and easy to set amplifiers up to drive a system without having to duplicate entering of parameters.

**Monitoring**

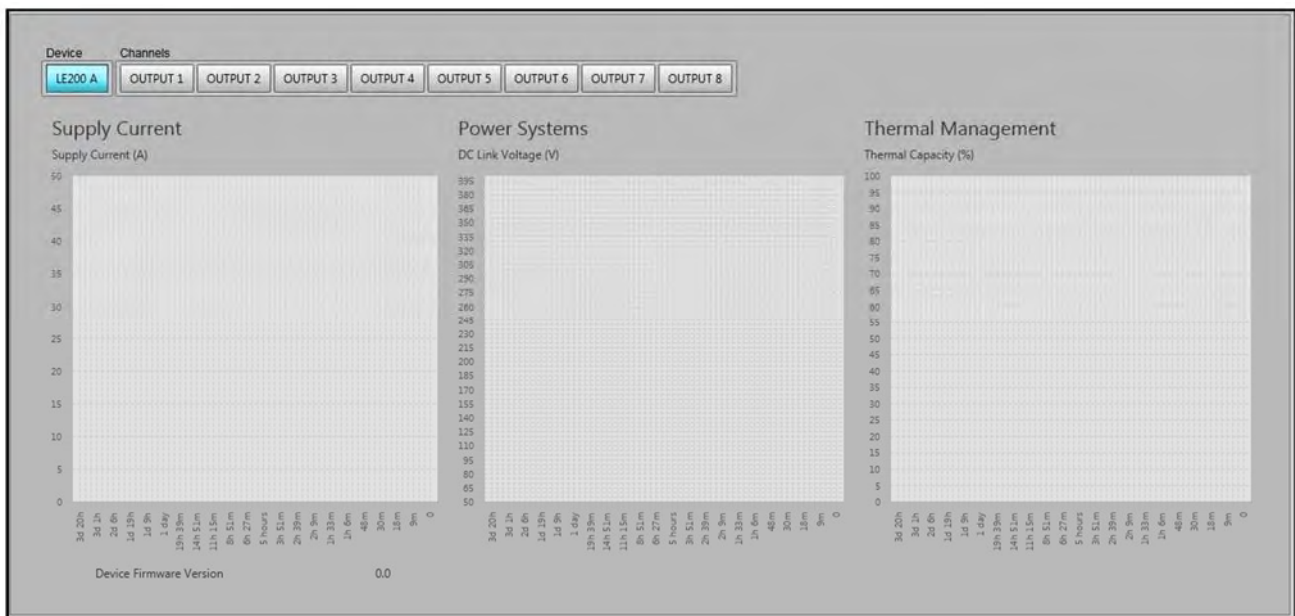

This shows the monitoring for the power supply plus the temperature map of the amplifier. The supply current being drawn is shown on the left graph (note that this amplifier is off line and therefore not driving a load therefore no current draw is shown) The DC Link Voltage is the D voltage at the first stage of the power supply and is derived from the mains voltage. The Thermal Capacity graph shows the temperature at which the amplifier is operating as a percentage of the total thermal capacity. The number of power cycles plus fan speed and number of PSU protection events- "PSU Over Temperature Mute Events" is shown.

You can also view the monitoring for each of the amplifier outputs by clicking on the Channel switches at the top of the page (iK81 shown); -



This will then display the Output current, Load Impedance and Protection status for the output selected; -

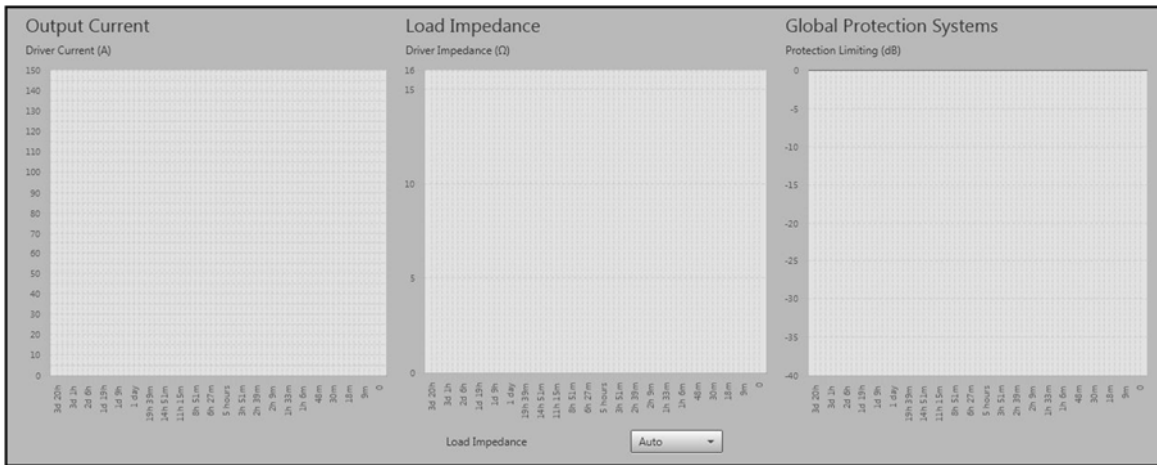

The load impedance can be automatically detected or can be selected to be either 25, 70 or 100V line, or a minimum of either 2, 3, 4, 6 or 8Ω

**Power**

The interface includes three sections: 'STANDBY TIME' with a checked 'MANUAL' box, a time selector set to 'mins', a green 'POWER ON' button, and a 'SYNC to all iKON amps' button; 'SLEEP TIME' with a checked 'MANUAL' box, a time selector set to 'mins', a green 'POWER ON' button, and a 'SYNC to all iKON amps' button; and 'EXTERNAL BREAKER PROTECTION' with a time selector set to '50.00' and 'A', a 'SUPPLY CURRENT: 0.0 A' display, and a 'SYNC to all iKON amps' button. Below these are explanatory text blocks for 'Standby' and 'Sleep' modes.

The power tab allows you to control the Standby and Sleep status of all amplifiers in the project.

Standby is a power save mode that can be activated either manually or after a set period of time from when an input signal was last detected. The amplifier goes into standby mode but will immediately switch to normal operation seamlessly as soon as a signal is detected on any input.

Sleep is a deeper power save mode, the amplifier can only be restored by a switch on command from Vu-Net or by power-cycling the amplifier using its front panel power switch.

By default, both options can be enabled manually. Un-checking the MANUAL box allows you to enter a time between 3 and 89 minutes; -

A close-up of the 'STANDBY TIME' section showing the 'MANUAL' checkbox is unchecked, and the time is set to '89 mins'.

Next is a Power On button which will defeat the Standby or Sleep mode and turn the amplifier on. You can sync the information from both modes to all amplifiers in the project so that they will all go into Standby or sleep modes at the same time according to the settings entered.

There is also maximum mains power protection to ensure that the amplifiers don't try to draw more current than is available from the mains supply.



By default this is set to 50amps, it can be set to any figure between 9 and 50 and as with the Standby and Sleep modes, the setting selected can be Synchronised to all amplifiers in the project.

## Preset Manager

Preset Manager is the powerful feature which enables the Ikon series to drive the Wavefront Precision series as well as many of Martin Audio's other speaker ranges. The configuration of multiple amplifiers is dealt with within Preset Manager

### Rack Management

The first stage of configuring a system is to arrange the amplifiers into racks to mirror how they are physically deployed. In a fixed installation they may well be in one large 19" installation rack, however in a touring environment it is likely that they will be distributed across several racks. The Accessories for the Wavefront Precision range include touring flightcased 19" racks which hold three iKon amplifiers.

When iKon amplifiers are added to a project by dragging across from the Palette when in off line mode, they will all be added to a single rack, when using Device Discovery they will be assigned to racks according to model- one for iK42s and one for iK81s. This (off line) project has six iK81s and six iK42s. Right clicking on any of the amplifiers in the System Diagram window and selecting **Open Preset Manager** will bring up the following window; -

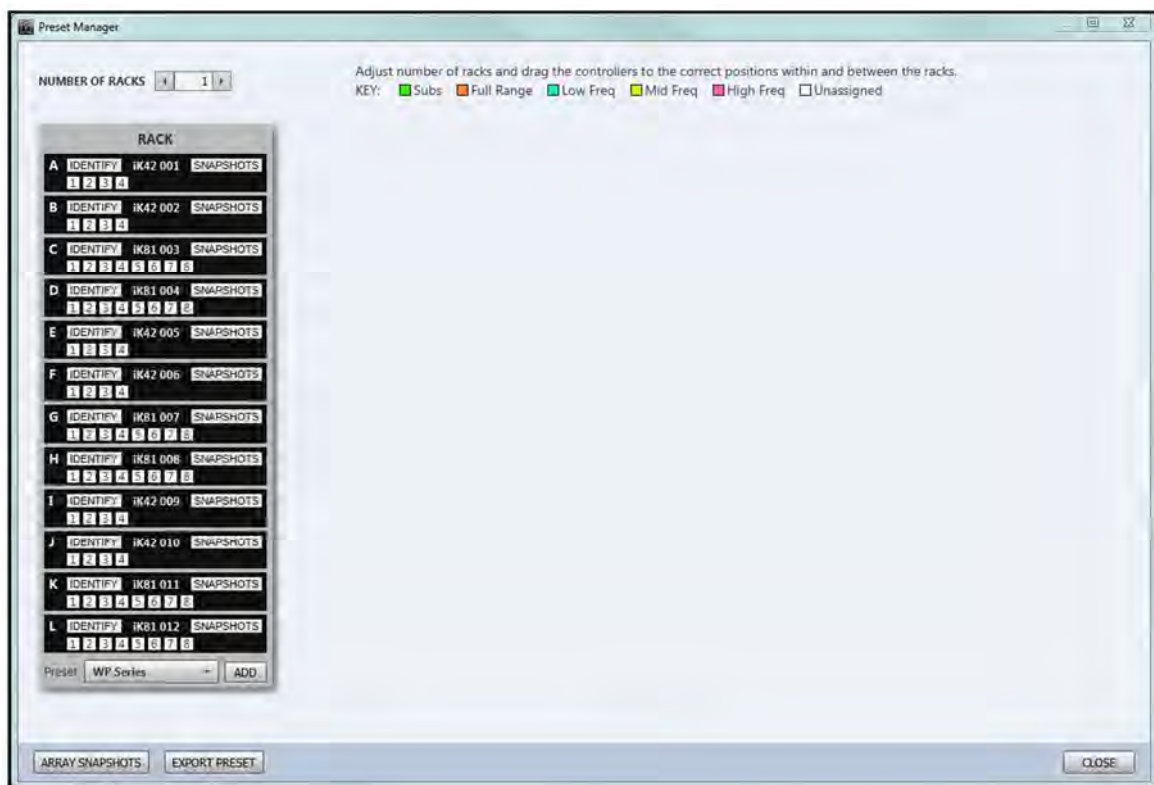

The Number of racks is shown at the top left with up and down arrows to adjust the quantity; -





To the right is a guide to the colour coding of amplifier channels. This will reflect what presets have been assigned to the channel as we will see later in this chapter. As none of our amplifiers have had a preset assigned, all channels are white; -

Adjust number of racks and drag the controllers to the correct positions within and between the racks.  
 KEY: ■ Subs ■ Full Range ■ Low Freq ■ Mid Freq ■ High Freq  Unassigned

Finally the rack with all amplifiers is displayed. The amplifiers are in the order in which they were added to the project or discovered so at present are in no particular order. If you need any assistance identifying amplifiers you can use the Identify switch; -



This will flash the LCD screen of the amplifier to help pick it out in a large system.



The first step is to increase the number of racks to the quantity that we wish to use. For touring applications for example the flightcase 19" racks for WP systems hold three amplifiers so we will increase the rack quantity to four by clicking on the right hand arrow on the Rack Quantity button; -



Our window now appears like this; -

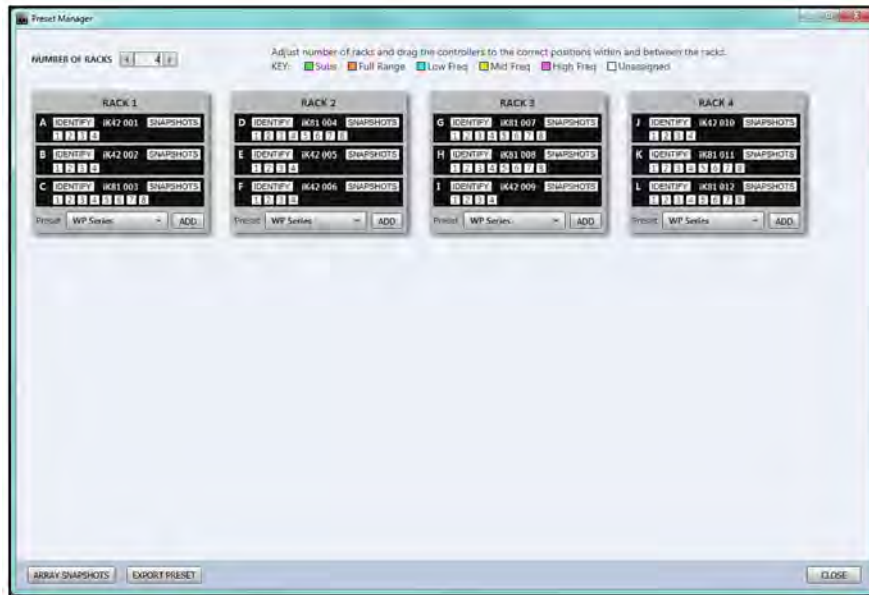

We now have four racks but the amplifiers are still in a random order. We would like to have identical amplifier models in each rack so we have two racks of iK81 and two of iK42. This is easily achieved by dragging and dropping racks between racks. If for example we decide that Racks 1 and two will be iK42 and Racks 3 and 4 will be iK81, we can start by clicking on 1K42 005 in rack 3 and dragging it over to Rack 1; -

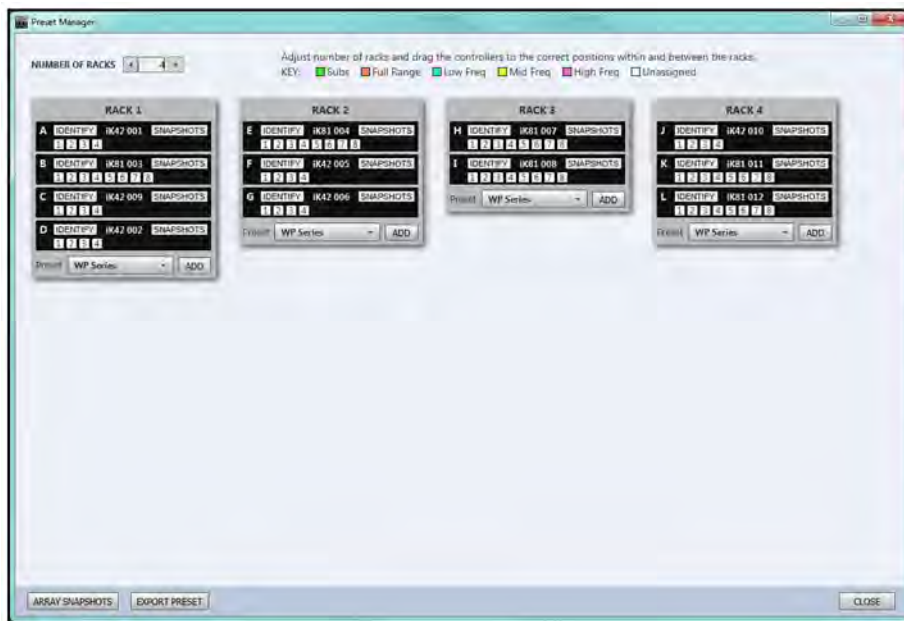

Now click in iK81 in Rack 1 and drag it over to Rack 3; -

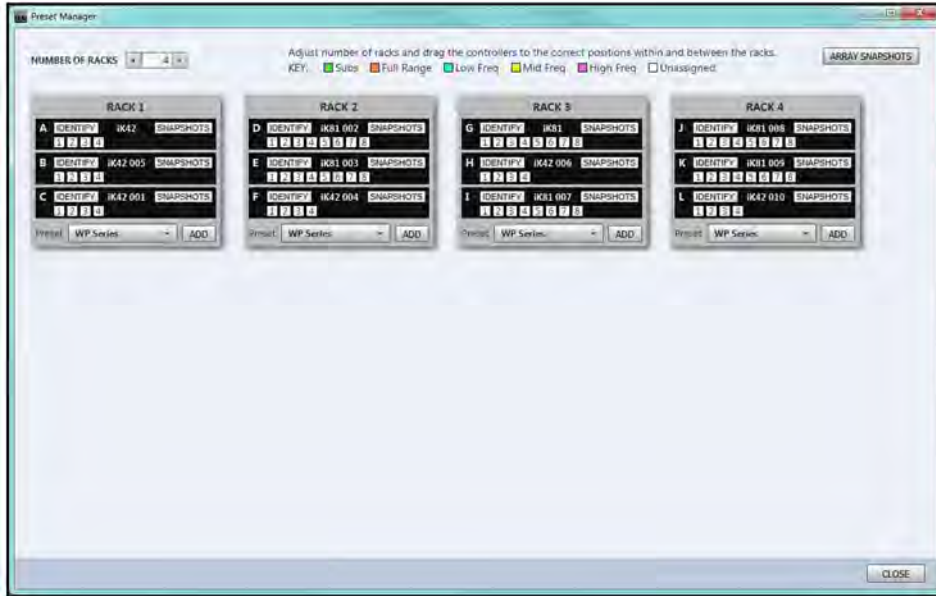

We can continue to drag and drop amplifiers to re-order our racks. Note that you can drag amplifiers within racks to keep their numbering sequential if you wish; -

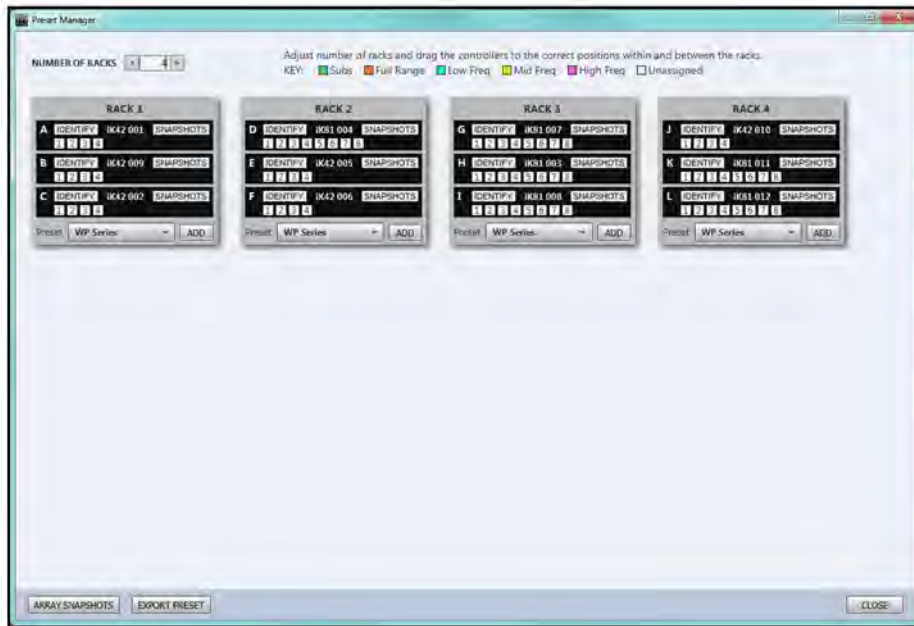

The System Diagram will now appear like this; -



A sensible next step would be to rename the amplifiers which will make it easier to manage the system as you can quickly identify what each amplifier is driving. Either right click on each amplifier and select **Rename**, or click on the amplifier and use the shortcut key F2. Rename the amplifier, the maximum characters are 30. Racks can also be renamed, click on the rack name just above the amplifiers and again either use right-click and select **Rename** or use the F2 shortcut.

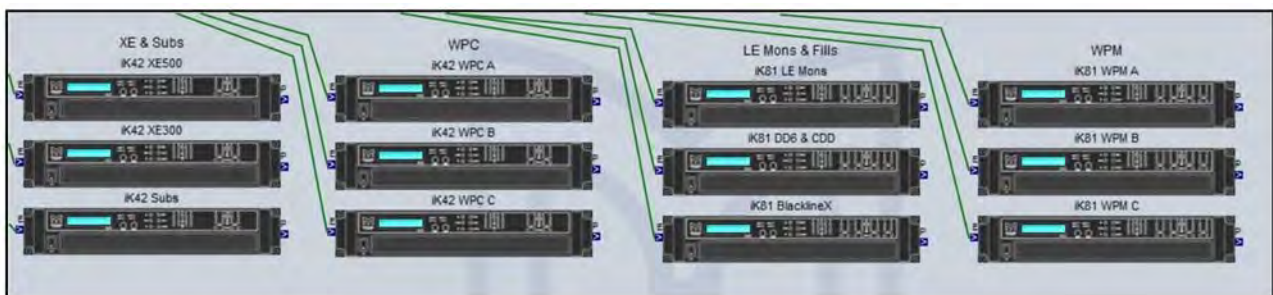

### Preset Loading

Loading Presets is easily achieved using the Preset Manager. Preset loading for Wavefront Precision systems is a little more involved where an optimisation file created using Display 2.3 is being used. We will first look at loading regular system presets. A full set of presets can be loaded into all amplifiers in a rack simultaneously if they are all using presets from the same group of products but you can revisit the preset loading at any time to upload new presets into any or all of the amplifiers.

In our first rack "XE & Subs", our first iK42 has been named "XE500" so we will load XE500 presets into all four channels. As the XE500 is a bi-amped product we will have two monitor mixes available on this amplifier.

First Preset selection button at the bottom of the rack (showing WP Series by default) and select XE Series from the drop-down list; -



Now click **ADD** and you will see the XE Series Preset Loader; -



Click on the **Select** button and choose **XE500** from the drop-down list; -



The Preset Loader will appear as shown; -



Under the XE500 selection the preset to be loaded is shown, in this case XE500 Bi-amp. As there is only one option for XE500, it cannot be run passively for example, there are no other choices in this drop-down. Next is the choice of Input channel and DSP. In usual mode when driving a bi-amp cabinet you would feed the input to a single channel. Choose from channel 1 to 4. The DSP will by default follow the input channel selection; DSP A for input 1, DSP B for input 2 and so on, you can however select any DSP should you need to change the default. We will use channel 1.

**Input EQ** is very useful if you are loading a new preset into an amplifier you have already been using and have applied some input EQ, say to compensate for room acoustics. By default **PRESERVE** is the option to retain any input EQ already programmed however you can flatten the input EQ by using clicking on **FLAT**.

Now click **ADD** and the window will show the following; -



The first line in the Input/Output section shows the input selected for the XE500 LF as channel 1, the DSP is A and the output is A1 meaning amplifier A (top amplifier in the rack), output channel 1. The second line also shows input 1 with the output on channel 2 of the same amplifier. We can change input channel, DSP and output channel here if required by using the arrowed buttons either side of the selection indicator. Note that this changes the LF and HF inputs independently. When running bi-amp wedges this is usually undesirable but as Vu-Net has presets for systems with combinations of subs and mid-high cabinets, in those instances you may well want to run a separate feed for subs.

The output selection can be any of the amplifier output channels in that rack. If you click on the right-hand arrow for the output it will scroll through A1, A2, A3, A4, B1, B2 and so on up to C4 which is the final channel in this rack. *Note that if you select the output to be one of the channels on amplifier B or C, the input channel selected will revert to the input on that amplifier.* Unsurprisingly you cannot feed a signal into one amplifier and output from another.

Note that the output channel cannot be the same for the LF as the HF. If we attempt to do this and click **Load** we will see the following window; -

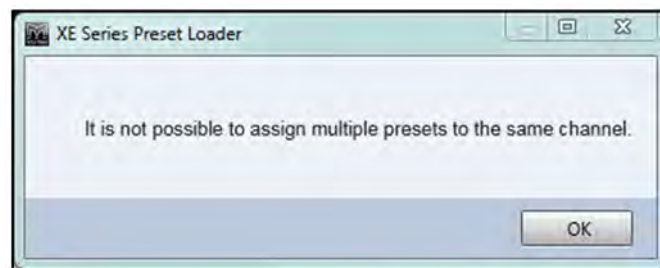

We will change our input to channel 2 and out outputs to channels 3 and 4; -



Now we will add another mix of XE500 to the same amplifier. As we moved the first set of presets to Input 2 we can leave the Input Channel choice on channel 1 and as we are loading the same XE500 bi-amp preset we don't need to change anything else, we can just click **ADD**.;



We could click **Load** at this point up upload the parameters to amplifier A but we will first populate the other amplifiers in the rack. The second amplifier (Amp B) is designated XE300 so at the top of the preset loader use the drop-down to select **XE300**. Now we have the option of Bi-Amp or Passive Presets;





We will select **Passive** for the XE300s so we can run four mixes using all four channels of amplifier 'B'. With passive selected and **Input 1** selected for the Input channel, click **ADD** four times; -



As you can see, the passive XE300 presets (shown as "XE300 P") have been assigned to amplifier B outputs 1 to 4. It isn't possible to over-write an amplifier preset which is why the Preset Loader didn't attempt to load the XE300 presets into amplifier A. If you do want to load a new preset into an amplifier you need to delete the existing preset using the delete button; -



As we didn't change the input channel, all four of our XE300 output presets are currently routed from Amplifier B input 1 and DSP A so now we need to edit these so output 2 is fed from input 2 and DSP B and so on by clicking on the right-hand arrow on the input and DSP selection; -

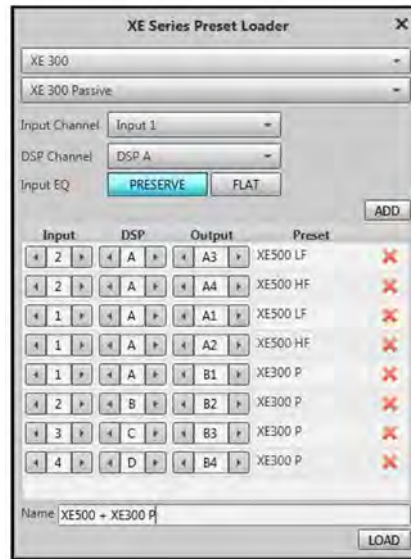

Note the Name at the bottom of the window which defaults to the last preset added. This will be shown in the Preset Manager Window when thumbnail images of the products are added. As this group is a mixture of monitors we will re-name them "XE Monitors". Note that if you don't require a label you can leave this section blank.

Finally, to complete our first rack, we will load some subs into the final amplifier "C". As the Subs are a different product group we need to load what we have done so far to the first two amplifiers. Click **LOAD** and you will briefly see a "Loading Preset" window and the Preset Manager window now looks like this; -

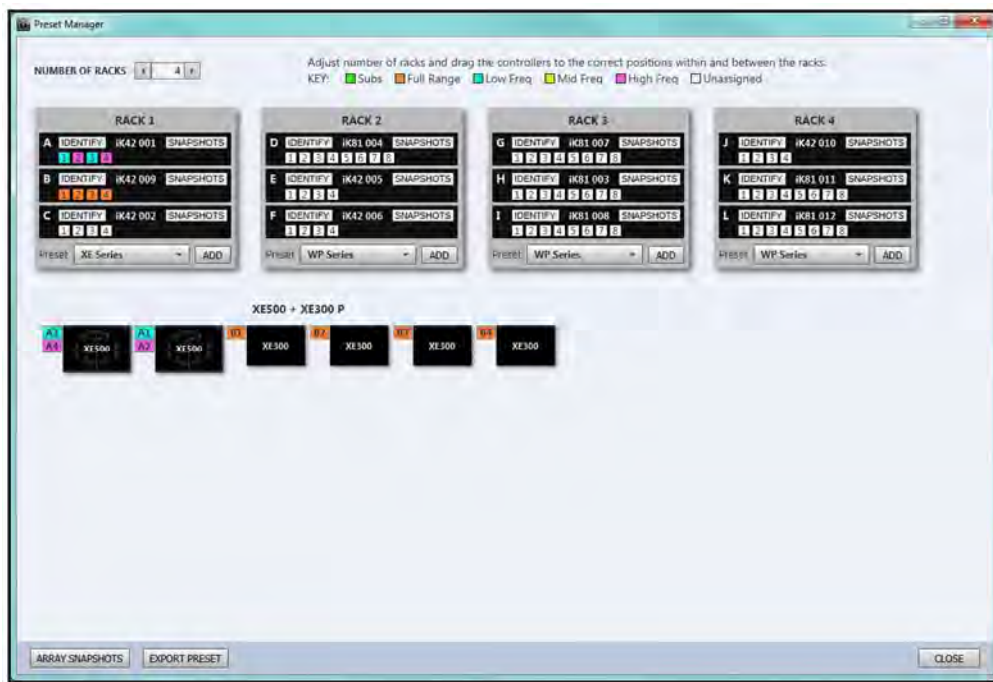

Output 1 and 3 on Amplifier A is now coloured light blue to designate that they are driving Low frequencies, channels 2 and 4 are pink as they are driving high frequencies. All four channels of Amplifier B are orange as they are running full range presets. We also have a line of thumbnail images of the products that we are driving which have a small square showing the amplifier channel or channels that are driving them.

To load subs onto Amplifier C, from the Preset drop-down select **SUBS** and click **ADD**; -

You not have the option of three groups of subs to choose from; -

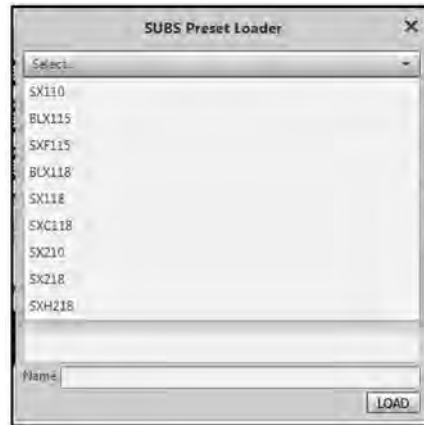

There are two categories of subs, those from the BlacklineX range; **BLX115** and **BLX118**, and the SX series starting with the single 10" **SX110**, up to the twin 18" hybrid loaded **SXH218**. Once the sub type is selected, there are further options to select the preset appropriate to the system with which they will be used. For example, selecting SX118, the next option is either generic for use with any system of your choice, with WPM or MLA Mini, or with WPC; -



Finally, a third option is for standard operation or for cardioid where the sub will be positioned facing backwards. The preset includes all necessary parameters including phase reverse, delay and EQ to maximise the cancellation behind the sub array to keep stages as quiet as practical, particularly useful when used with the hard avoid feature available with Martin Audio optimised arrays; -



Here we have selected the generic SX range then chosen SX118 and added them to channels 1 and 2, and then added SX218 to channels 3 & 4; -



As you can see, due to the presets already loaded into Amplifiers A & B the Sub presets are automatically loaded into Amplifier C. Once again the product group Name at the bottom has defaulted to the SX218 as that was the last preset added. As we have a mixture of subs we will rename it "SX Subwoofers". Once loaded into the amplifier the Preset Manager appears like this; -

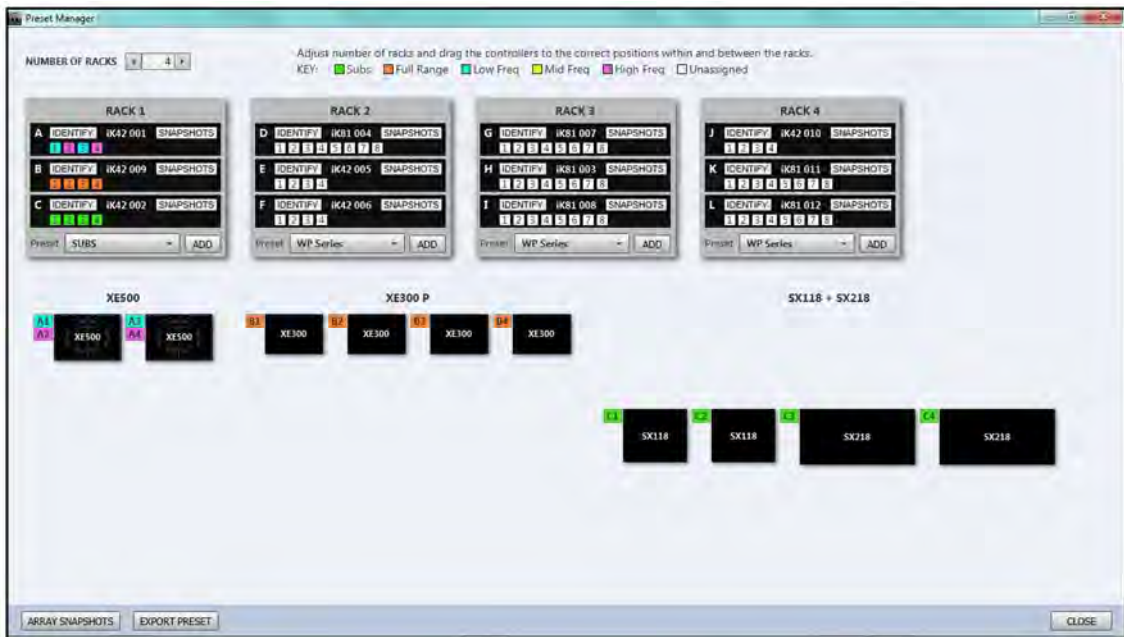

The four outputs of Amplifier C are now coloured green to show they are driving subs and thumbnail images of the subs have been added.

Loading presets into an iK81 is identical, we will look at an example of loading BlacklineX presets into some channels of amplifier "I". Here we have selected **BlacklineX** and chosen **BlacklineX + sub**. We have selected the combination of the X12 HP (high pass) and the X115; -



We have an additional option with this preset in that we can choose to load the parameters for both the X12 and X115 or just one or the other by using the two tick boxes. You might want to use the X12 for example with the high pass filter in place and use an alternative subwoofer. Assuming we want both channels we can leave both boxes ticked, select the input and DSP channel and whether we want the input EQ preserved or flattened and click **ADD**; -



This is an example where you might want to drive the input from two channels so you have independent control of sub and mid-high levels from say, sends on your mixer. It is worth mentioning however that the iK81 has eight outputs but only four inputs. This makes it ideal for running up to four bi-amped systems but only if they are each fed from a single input.

### Wavefront Precision

To get the best possible results from Wavefront Precision systems you should create a d2p optimisation file using Display 2.3. There is a basic emergency preset however a d2p file optimised precisely for the space in which the array is deployed will undoubtedly give the best possible results. For full details on creating Display 2.3 projects please visit the Martin Audio website and navigate to the software section. The Display 2.3 application download and User Guides are available.

The number of amplifiers required to run a WPM, WPS, WPC or WPL system is a factor of the size of the array and the resolution selected, see the following tables, first WPM

WPM iK81 requirements								
Array Size	1 box Resolution		2 Box Resolution		3 Box Resolution		4 Box Resolution	
	No of Channels	No of iK81	No of Channels	No of iK81	No of Channels	No of iK81	No of Channels	No of iK81
1	1	1 (7 ch spare)	N/A	N/A	N/A	N/A	N/A	N/A
2	2	1 (6 ch spare)	1	1 (7 ch spare)	N/A	N/A	N/A	N/A
3	3	1 (5 ch spare)	2	1 (6 ch spare)	1	1 (7 ch spare)	N/A	A/A
4	4	1 (4 ch spare)	2	1 (6 ch spare)	2	1 (6 ch spare)	1	1 (7 ch spare)
5	5	1 (3 ch spare)	3	1 (5 ch spare)	2	1 (6 ch spare)	2	1 (6 ch spare)
6	6	1 (2 ch spare)	3	1 (5 ch spare)	2	1 (6 ch spare)	2	1 (6 ch spare)
7	7	1 (1 ch spare)	4	1 (4 ch spare)	3	1 (5 ch spare)	2	1 (6 ch spare)
8	8	1	4	1 (4 ch spare)	3	1 (5 ch spare)	2	1 (6 ch spare)
9	9	2 (7 ch spare)	5	1 (3 ch spare)	3	1 (5 ch spare)	3	1 (5 ch spare)
10	10	2 (6 ch spare)	5	1 (3 ch spare)	4	1 (4 ch spare)	3	1 (5 ch spare)
11	11	2 (5 ch spare)	6	1 (2 ch spare)	4	1 (4 ch spare)	3	1 (5 ch spare)
12	12	2 (4 ch spare)	6	1 (2 ch spare)	4	1 (4 ch spare)	3	1 (5 ch spare)
13	12	2 (3 ch spare)	7	1 (1 ch spare)	5	1 (3 ch spare)	4	1 (5 ch spare)
14	14	2 (2 ch spare)	7	1 (1 ch spare)	5	1 (3 ch spare)	4	1 (5 ch spare)
15	15	2 (1 ch spare)	8	1	5	1 (3 ch spare)	4	1 (5 ch spare)
16	16	2	8	1	6	1 (2 ch spare)	4	1 (5 ch spare)

WPS is a passive enclosure designed to be used with the iK42 and can be run in one or two box resolution in arrays up to 24 enclosures deep; -

WPS iK42 requirements				
Array Size	1 box Resolution		2 Box Resolution	
	No of Channels	No of iK42	No of Channels	No of iK42
1	1	1 (3 ch spare)	N/A	N/A
2	2	1 (2 ch spare)	1	1 (3 ch spare)
3	3	1 (1 ch spare)	2	1 (2 ch spare)
4	4	1	2	1 (2 ch spare)
5	5	2 (3 ch spare)	3	1 (1 ch spare)
6	6	2 (2 ch spare)	3	1 (1 ch spare)
7	7	2 (1 ch spare)	4	1
8	8	2	4	1
9	9	3 (3 ch spare)	5	2 (3 ch spare)
10	10	3 (2 ch spare)	5	2 (3 ch spare)
11	11	3 (1 ch spare)	6	2 (2 ch spare)
12	12	3	6	2 (2 ch spare)
13	13	4 (3 ch spare)	7	2 (1 ch spare)
14	14	4 (2 ch spare)	7	2 (1 ch spare)
15	15	4 (1 ch spare)	8	2
16	16	4	8	2
17*	17	5 (3 ch spare)	9	3 (3 ch spare)
18*	18	5 (2 ch spare)	9	3 (3 ch spare)

<b>19*</b>	19	5 (1 ch spare)	10	3 (2 ch spare)
<b>20*</b>	20	5	10	3 (2 ch spare)
<b>21*</b>	21	6 (3 ch spare)	11	3 (1 ch spare)
<b>22*</b>	22	6 (2 ch spare)	11	3 (1 ch spare)
<b>23*</b>	23	6(1 ch spare)	12	3
<b>24*</b>	24	6	12	3

\*Touring flying grid only

And this is for WPC and WPL (Note that WPL can only be run in 1 or 2 box resolution)

WPC and WPL iK42 requirements						
Array Size	1 box Resolution		2 Box Resolution		3 Box Resolution (WPC Only)	
	No of Channels	No of iK42	No of Channels	No of iK42	No of Channels	No of iK42
<b>1</b>	2	1 (2 ch spare)	N/A	N/A	N/A	N/A
<b>2</b>	4	1	2	1 (2 ch spare)	N/A	N/A
<b>3</b>	6	2 (2 ch spare)	4	1	1	1 (2 ch spare)
<b>4</b>	8	2	4	1	2	1
<b>5</b>	10	3 (2 ch spare)	6	2 (2 ch spare)	2	1
<b>6</b>	12	3	6	2 (2 ch spare)	2	1
<b>7</b>	14	4 (2 ch spare)	8	2	3	2 (2 ch spare)
<b>8</b>	16	4	8	2	3	2 (2 ch spare)
<b>9</b>	18	5 (2 ch spare)	10	3 (2 ch spare)	3	2 (2 ch spare)
<b>10</b>	20	5	10	3 (2 ch spare)	4	2
<b>11</b>	22	6 (2 ch spare)	12	3	4	2
<b>12</b>	24	6	12	3	4	2
<b>13</b>	26	7 (2 ch spare)	14	4 (2 ch spare)	5	3 (2 ch spare)
<b>14</b>	28	7	14	4 (2 ch spare)	5	3 (2 ch spare)
<b>15</b>	30	8 (2 ch spare)	16	4	5	3 (2 ch spare)
<b>16</b>	32	8	16	4	6	3
<b>17*</b>	34	9 (2 ch spare)	18	5 (2 ch spare)	N/A	N/A
<b>18*</b>	36	9	18	5 (2 ch spare)	N/A	N/A
<b>19*</b>	38	10 (2 ch spare)	20	5	N/A	N/A
<b>20*</b>	40	10	20	5	N/A	N/A
<b>21*</b>	42	11 (2 ch spare)	22	6 (2 ch spare)	N/A	N/A
<b>22*</b>	44	11	22	6 (2 ch spare)	N/A	N/A
<b>23*</b>	46	12 (2 ch spare)	24	6	N/A	N/A
<b>24*</b>	48	12	24	6	N/A	N/A

\*WPL Only

### WPM

Using our existing project example we have a rack of three iK81 amplifiers therefore we have a total of 24 channels available. To demonstrate we will create a stereo WPM system using 12 box arrays in 1 box resolution which will use all three of the iK81. We will need a d2P file created in Display 2.3 with exactly this configuration or it will not be possible to upload the correct parameters to the system.

As before, we open the Preset Manager and using our WPM rack we leave the default WP Series Preset visible click on **ADD**; -



The next step is to load our D2P file however it is possible to load a general preset which will work if you do not have the time to create an optimised file. Click on **Preset** and select **Emergency Default**



We however will load our preset file (all other steps are identical). Click **Select** and navigate to the file location for your d2p file. If you created it on another PC you can copy it onto a USB memory stick and navigate to that drive to find the file. The file location will be shown in the File window and the Preset list will show as many presets as you exported into your d2p file plus the Emergency Default; -



If we select our optimised Preset, the info window will display details of our project design; -



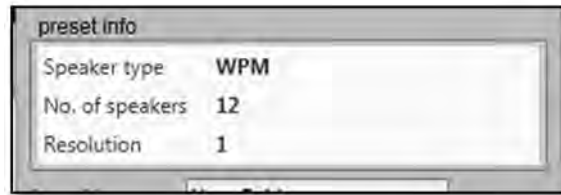

The array name defaults to the name that we gave the array in Display 2.3. The next choice is to select the amplifier channel to which the files will be uploaded. It will default to the first available channel, in our example Amplifier "J" channel 1. In default mode it will automatically upload to as many consecutive channels as are required, in our example twelve channels so all eight channels of amplifier "J" plus four from amplifier "K"; -



If we need to refine which amplifier channels are used we can manually edit this by clicking on the **Manual** button; -



We can go through each of the twelve amplifier channels required and select which channel we wish to assign the optimisation to. In the majority of cases this is not required so the automatic routing can be used.

As with other systems the input channel and DSP can be selected. Note that where an optimisation requires more than one amplifier as in our example, the input channel selection will apply to all amplifiers required. We can again select whether the input EQ should be Normal or any existing EQ retained. We will stick with Input Channel 1 and Normal EQ and click **LOAD**. This is how our amplifier rack appears:-



Note the 12 amplifier channels which are now orange to denote full range. We also have an array thumbnail labelled with our array name and showing which amplifier channels are driving which section; -



If we now open the two amplifiers "J" and "K" we can see how the optimisation upload has changed the parameters. If we look at the output of iK81 "J" that we renamed "WPM A"; -

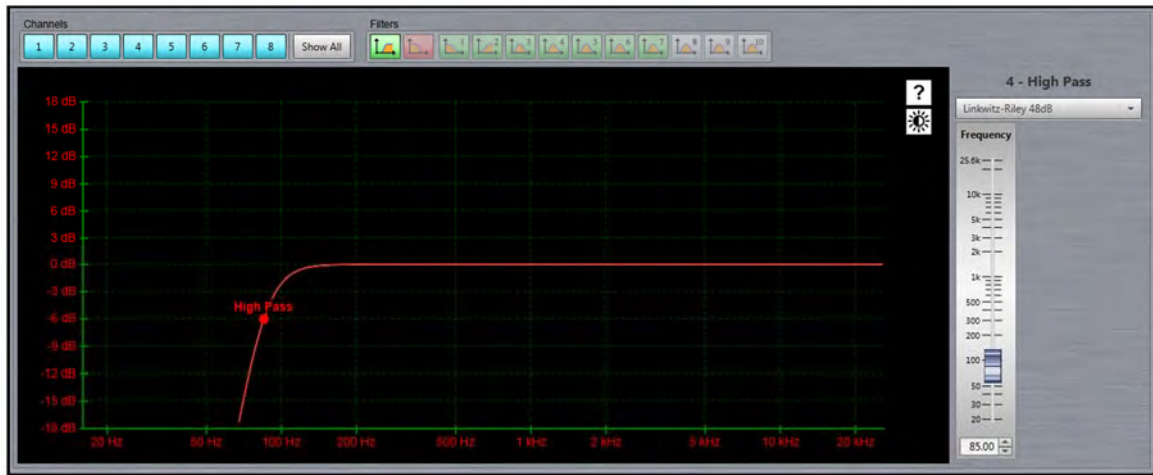

We can see that all of the output channels are ganged together as shown by all of the Channel buttons being illuminated; -



But all of the output filters are greyed out as they now contain the optimisation EQ and any changes would ruin the calculated parameters. The one filter that is still active is the high pass enabling us to set the crossover point between the WPM array and the subwoofers; -

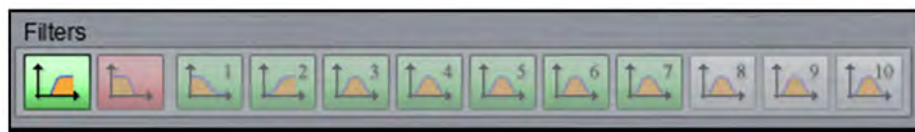

If we now look at the input; -



As we designated the input for our array to be channel 1, input DSP A has the standard WPM input EQ applied. Had we specified "Preserve" when loading the preset this EQ would not be present and any EQ that we had previously applied would still be present. The Input EQ is not locked out and can be freely edited to compensate for room acoustics or any preferences to suit the program material or engineer tastes.

If we look at the second amplifier iK81 "J" or as we labelled it "WPM B"; -

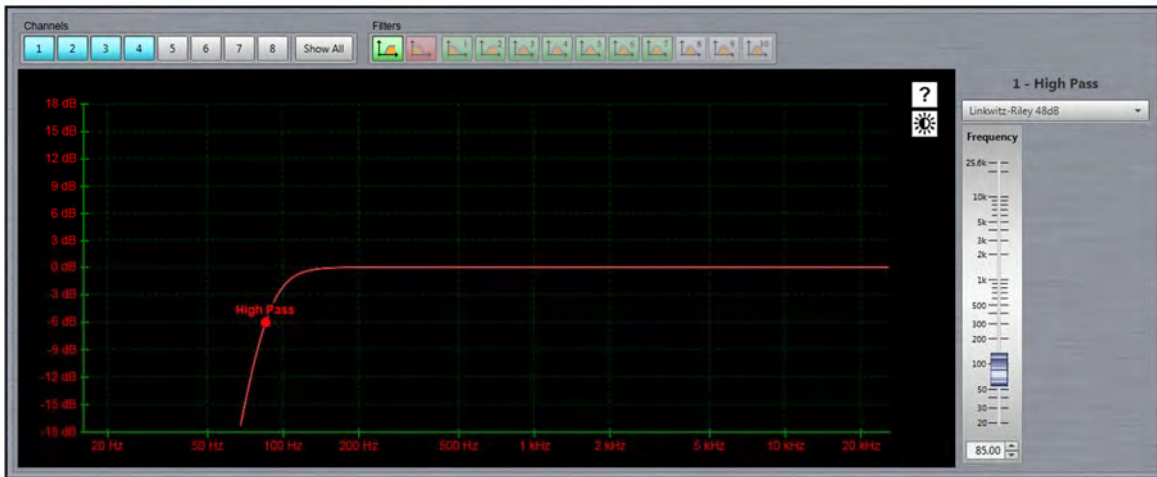

You can see that outputs 1 to 4 are similarly ganged and locked-out as the optimisation used 12 channels in total, 8 on the first amplifier and four on this. Channels 5 to 8 are still available for any other use; -

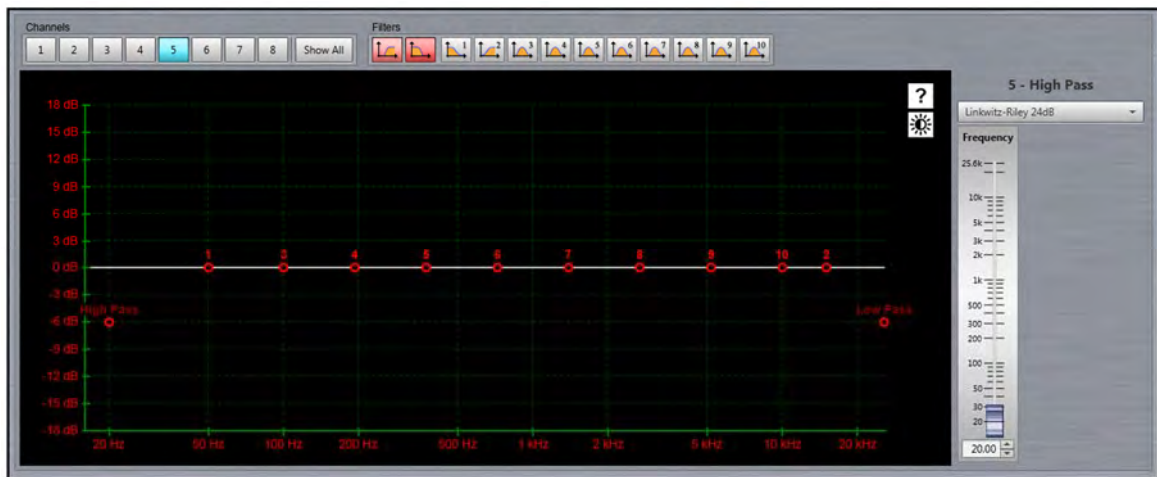

If we look at the input; -



It is identical to iK81 WPM A and the inputs are ganged together, any EQ changes made on either input will be duplicated so the same EQ is applied to the entire array. We can see this in the ganging Window; -

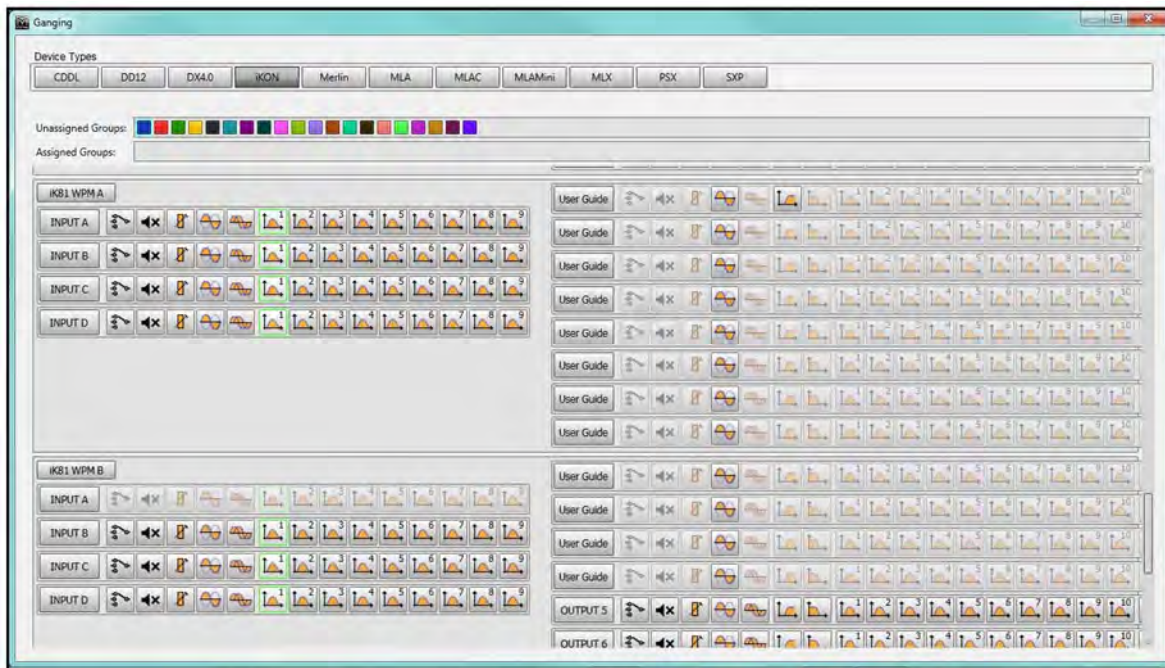

You can see input A on iK81 WPM A is available for editing, Input A on the second amplifier iK81 WPMB is greyed out. This is because it is internally ganged so that any editing on the first amplifier will be duplicated on the second so you cannot have the top 2/3rds of the array sounding different to the bottom 1/3<sup>rd</sup>. The 12 output channels- all 8 on the first iK81 and 4 on the second- are all greyed out so other than the output polarity (which can be ganged using a User ganging group). The highpass filter on the first output channel is shown as available, all of these on subsequent channels used in the array are also internally ganged. This is so that it is impossible to set different highpass settings for each element in the array.

Note however that whilst the inputs are ganged, they will need the same signal applied to them, there is no way within Vu-Net to route signals between amplifiers. It is however very simple to connect an analogue input to the first amplifier and use the link out and a short XLR cable to connect to the second amplifier. If using a Dante feed, the inputs on both amplifiers should be routed to the same source using Dante Controller.

As we want to run out system in stereo we now need to upload the same optimisation to the remaining amplifier channels. Open Preset Manager and on the WPM rack, click **ADD** with the default **WPM Series** showing in the Preset box. Click **Select** and navigate to the same d2p file and choose the Preset from the file in the **Preset Box**; -



You will notice that the **Load From** section has selected channel K5 as this is the next available channel. We could however change this as previously by using the **Manual** button. Let's say for example that we wanted the third amplifier- "WPM C" to have the first 8 channels with the final four on amplifier B, click **Manual** and change the channels as shown; -



The next modification that we must make is to change the Input. As the first array is using input 1, assuming we want to drive our two arrays with independent signals for stereo use, we must use an alternative input for the second array as both arrays are using output channels on the second iK81 "WPM B". Change the input to Input 2 and click **Load**; -



We again see the Preset Loading Window; -



The rack is now fully populated with settings; -



And we have two identical array thumbnails both showing the amplifier channel driving each array element; -



If we look at the Ganging Window again, it gives us a good overview of how the entire rack is configured; -

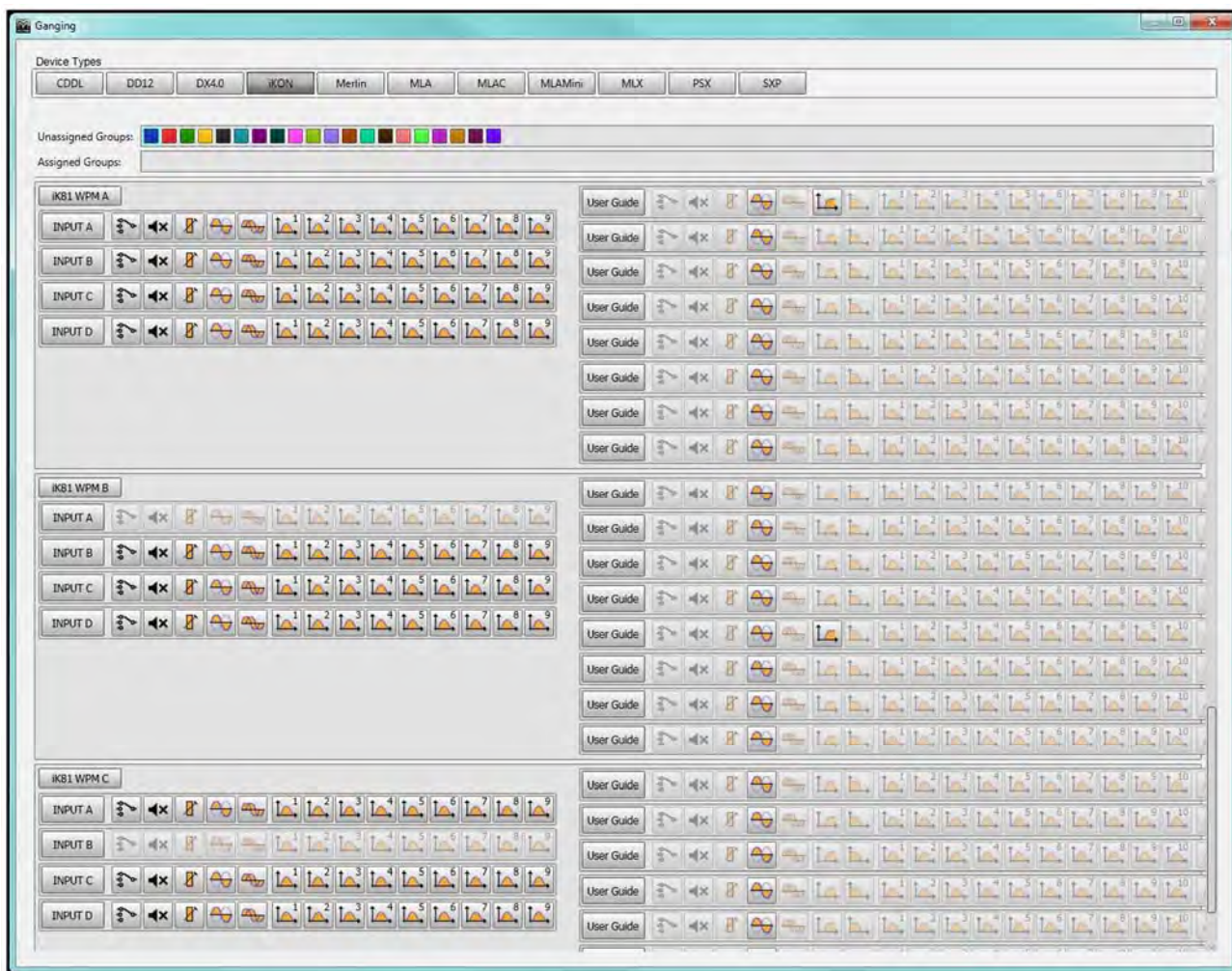

We can see how the internal ganging on the inputs is arranged and how all outputs are greyed with the high pass filters available and internally ganged together. Input 1 on both iK81 WPM A and B are internally ganged and input 2 on iK81 WPM B and C are also ganged. Note that it would be perfectly acceptable to add user ganging groups to inputs 1 & 2 and to the highpass filters. This would ensure that any changes made would keep both arrays completely matched. We have also ganged the output polarity on all outputs (we have checked that our speaker wiring is all correct and in-phase!); -



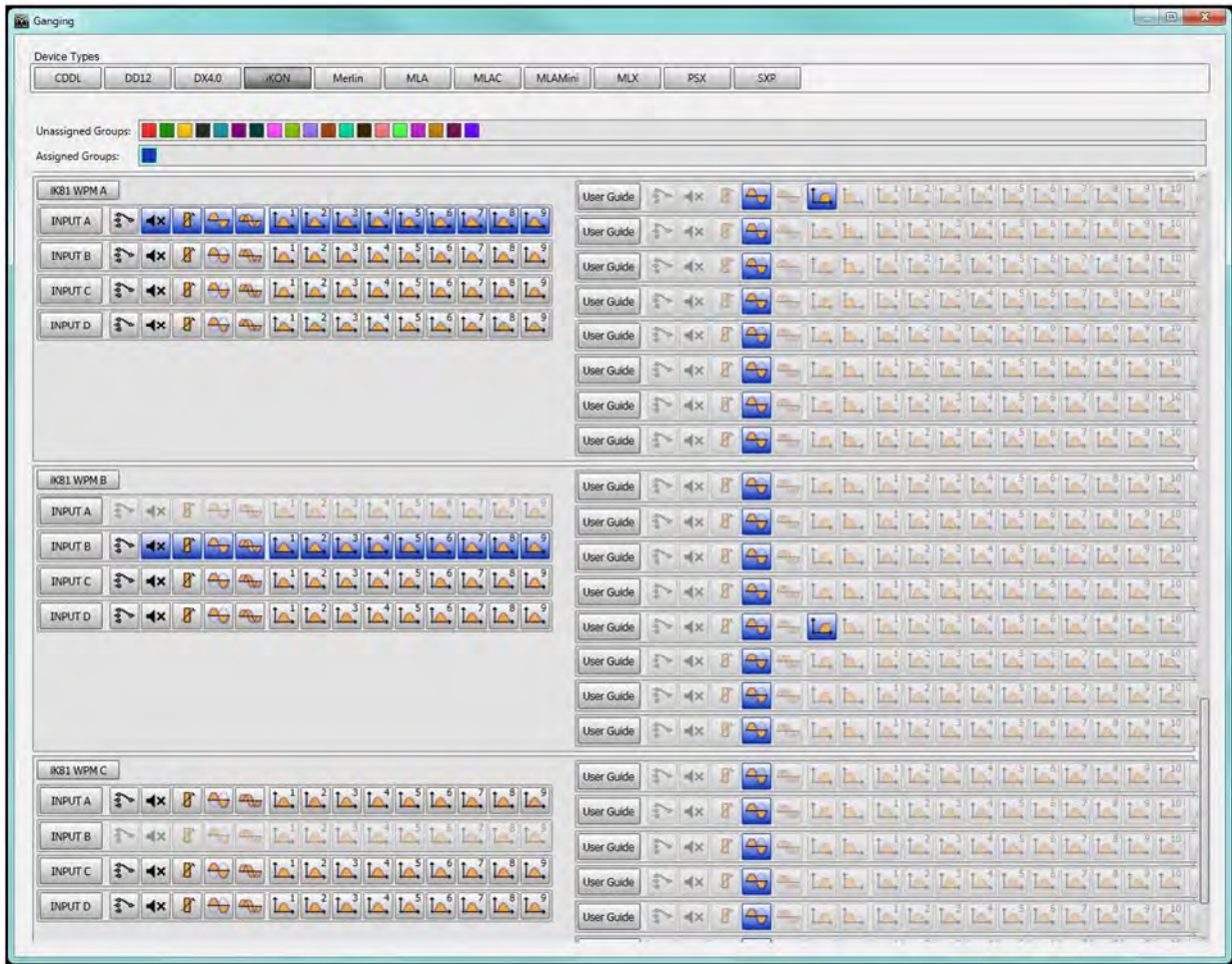

## WPS

WPS is a three-way passive enclosure so deployment is similar to the WPM but as it has a significantly higher power rating it is designed to be used with the iK42 amplifiers in either one or two box resolution. To demonstrate loading an optimisation we will look at an optimisation file for two 12 cabinet arrays run at 2 box resolution and therefore requiring 6 channels of amplification per array. We will load the optimisation across three iK42s to run two arrays.

To start, with at least three iK42 in a Vu-Net project, right click and select **Preset Manager**. With the Preset selection displaying the default **WP Series**, click **ADD**; -



Click on **Select** at the top of the window and navigate to the file location where the optimisation d2p file is located for the WPS array, open the file and then select the appropriate Preset from the drop-down. If you only exported a single optimisation the selection will be limited to the optimised array and the Emergency Default; -



Vu-Net has identified that the array is 12 speakers at 2 box resolution. It will load from channel 1 on the first iK42 ("A") fed via input 1 and DSP A. You can select the Normal EQ which adds a standard voicing curve to the input DSP, or flat if you wish to add your own EQ. The file will load into 6 consecutive channels on amplification therefore using all four channels of one iK42 and two channels from the next. Click LOAD to upload the optimisation. In Preset Manager we can now see that the amplifiers have 6 channels showing a full range orange flag; -

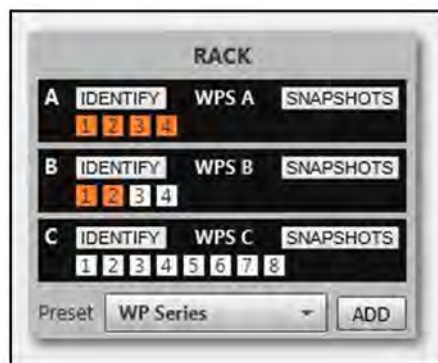

We also now have a thumbnail of our array showing which amplifier channels are driving which segments of the array; -



We can now repeat the process to load the same optimisation to run two arrays; -



Vu-Net will always load amplifier channels sequentially so channel 3 from the second amplifier will be the first output channel used. The input is defaulting to channel 1 but via DSP B. this isn't going to work for a stereo system so we need to make some changes. We can also change the output routing, say for example that we wanted to load the first 4 channels of the optimisation into amplifier C with just the last two channels on amplifier 2 to mirror the first array, click on **Manual**; -



We can change Preset WPS 01 from output B3 to output C1, WPS 03 to output C2 and so on. Also changing Input channel to Input 2; -



Click **LOAD** to upload the optimisation into the amplifiers, The amplifiers are now fully populated and we have two thumbnail arrays showing which amplifier channels are driving each section of the arrays; -



We can look at the amplifier parameters in Vu-Net, this is the routing page; -

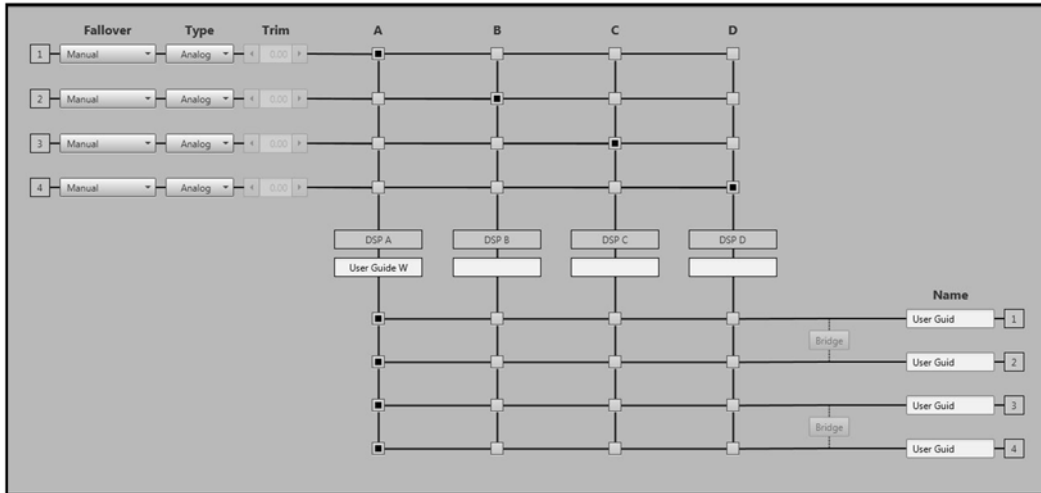

As we selected, input is via input 1 via DSP A and routed to all output channels. The input DSP shows the standard voicing curve. This would be flat had we elected the Flat option before loading the optimisation; -



The putput DSP appears with all filters greyed out other than the highpass filter; -



This allows you to change the high pass filter for applications when the array is used with subwoofers. All other filters are unavailable to stop the optimisation from being ruined by entering settings on individual outputs. We can see how all three amplifiers are configured in the ganging window; -

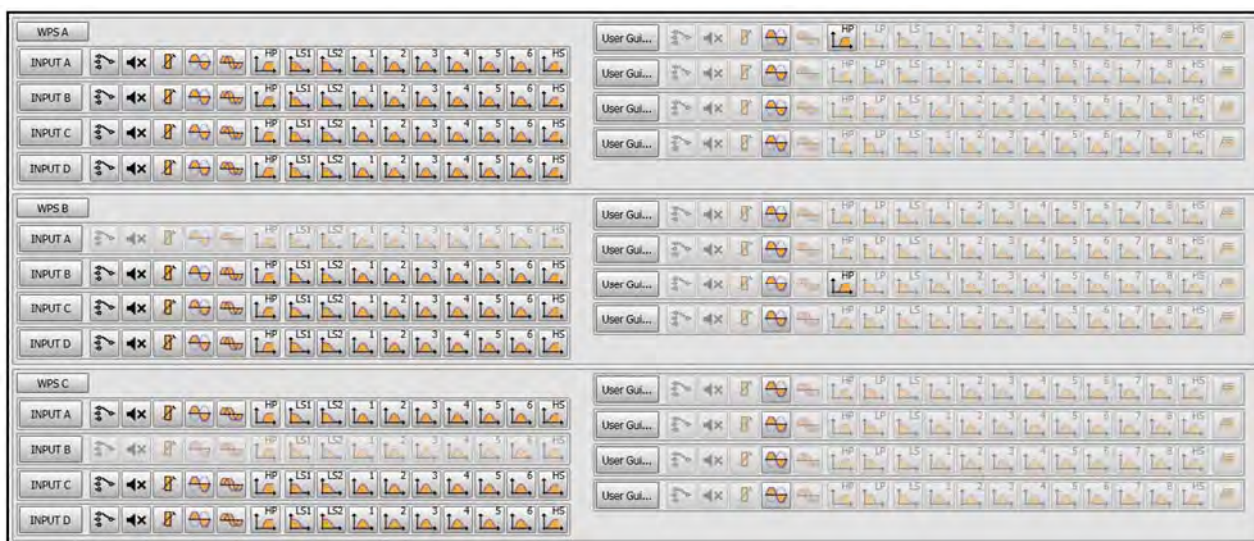

Input is via channels 1 and 2 so input 1 is greyed out on amplifier B and input 2 is greyed out on amplifier C to ensure that inputs are matched. All output parameters are greyed out other than output phase and highpass filter on the first amplifier in each array. The polarity option is available as a quick fix for faulty speaker cables that may be wired out of phase which would destroy the carefully optimised array performance.

The highpass filter allows us to set a suitable frequency when using subs. Although only the first amplifier in each array shows the high pass filter as available, these are factory ganged to all other channels used to drive each array to ensure that they are all matched to the setting on the first channel.

To ensure that any changes to the array are matched we can gang both arrays including the high pass filters in the outputs. Note that the polarity filters should only be ganged once the system has been tested and we are certain that all of the speaker wiring is correct without any out of phase faults; -



Note that input channel 1 on amplifier A needs to be linked to input channel 1 on amplifier B and input channel 2 on amplifier B needs to be linked to input channel 2 on amplifier C. This can easily be achieved within Dante controller if the source is Dante, if we are feeding the amplifiers with an analogue source, we will need to use short XLR link cables to link through from the first amplifier to the next.

## WPC

We will now repeat the Preset Upload process for the WPC system on the second rack with iK42 WPC A, B and C. We have a total of 12 channels available and wish to drive two arrays so the system is going to be two arrays of six WPC run at 2 box resolution.

As before, open Preset Manager leaving the default "WP Series" visible in the Preset box, click **ADD**. Navigate to the WPC d2p file created in Display 2.3 and select the Preset from the optimisation file. Note that there is also an Emergency default preset for WPC if required; -



Accept the default Output Channels loading from amplifier **D1** ("WPC A"), input channel **Input 1**, DSP channel **DSP A** and Input EQ **Normal**. Click **LOAD** and the file is uploaded to the amplifiers. We can again see the output channels have been assigned in the rack; -

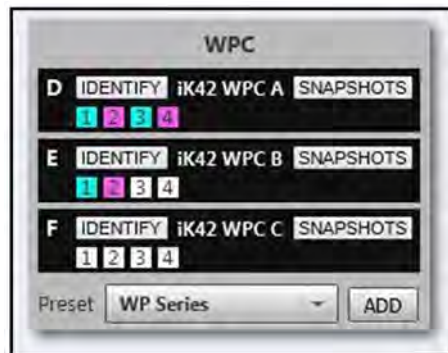

However, as the WPC is a bi-amp cabinet, alternate channels are colour coded light blue for low frequency, and pink for high frequency. Now repeat the process for the second array, the only change is to edit the input to Input 2/ DSP B as we are running in stereo; -



Load the settings and the rack is now fully populated; -



And we have two WPC Array thumbnails showing the amplifier channel routing; -

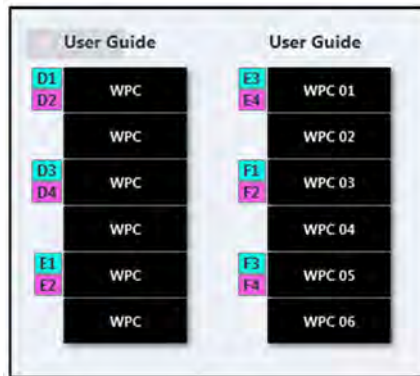

If we again take a look at the ganging window it gives us an excellent overview of how the system is configured; -



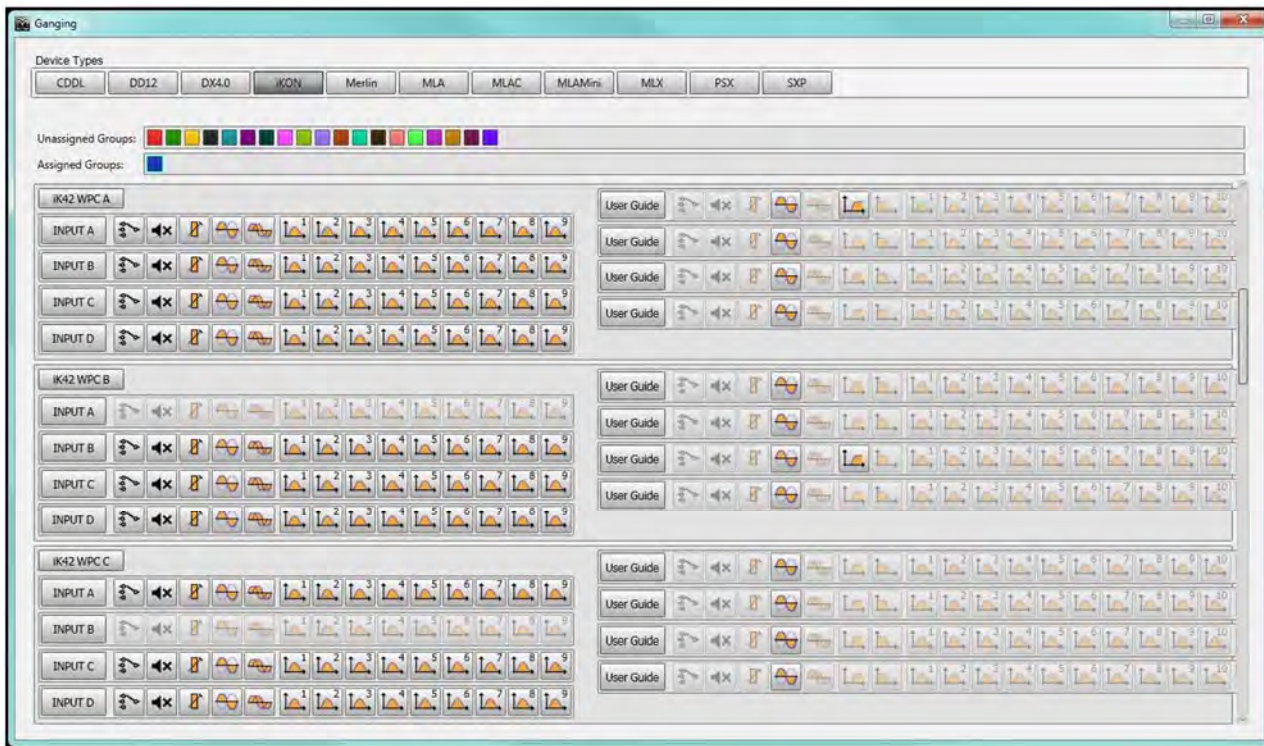

As before, input A on both i42 WPC A and B are internally ganged as are inputs B on iK42 WPC B and C. All output parameters other than the polarity and high pass filters on the output channels of IK42 WPM A 1 and IK42 WPM B are greyed out. These can be edited to set the crossover point between the WPC arrays and the subwoofers. Once again, all input and all highpass filters can be added to the same ganging groups to ensure that the array parameters remain perfectly matched within our stereo system; -

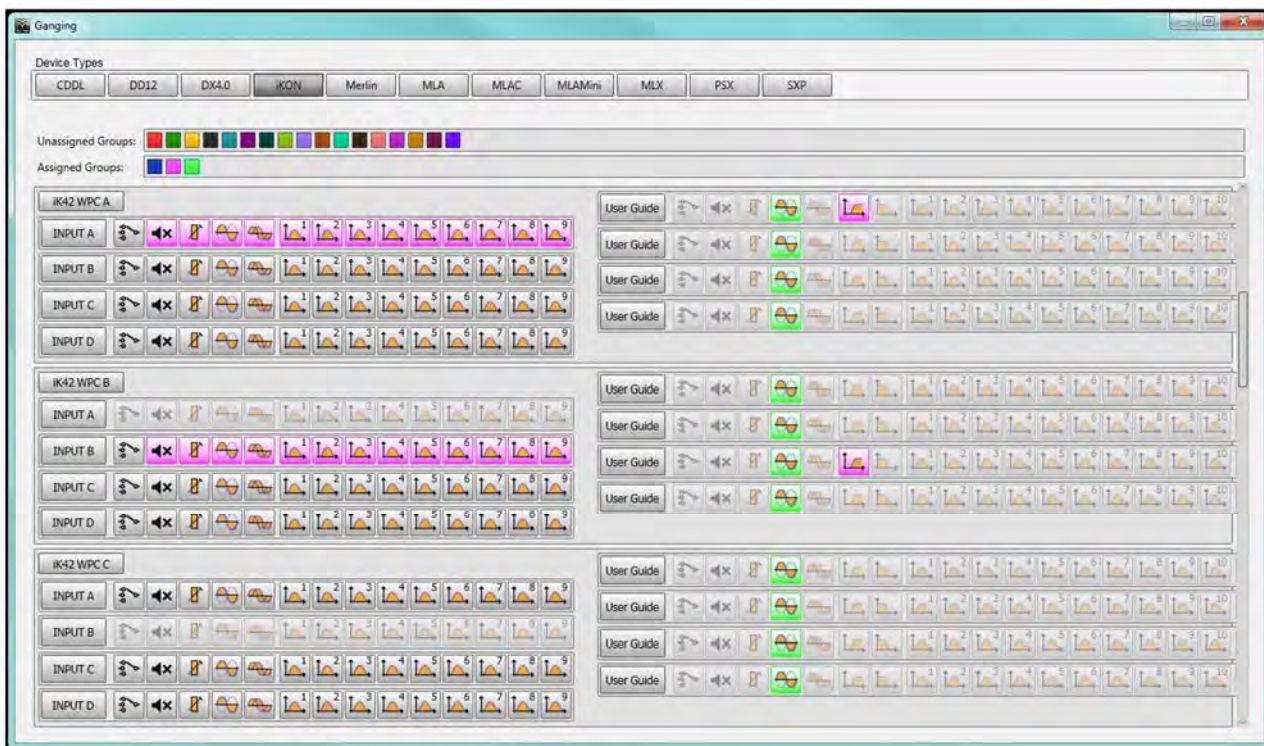

## WPL

We will now look at the Preset Upload process for the WPL system using two racks of iK42. We have a total of 24 channels available and will drive a single array in one box resolution.

As before, open Preset Manager leaving the default "WP Series" visible in the Preset box, click **ADD**. Navigate to the WPLd2p file created in Display 2.3 and select the Preset from the optimisation file. Note that there is also an Emergency default preset for WPL if required; -



Accept the default Output Channels loading from amplifier **D1**, input channel **Input 1**, DSP channel **DSP A** and Input EQ **Normal**. Click **LOAD** and the file is uploaded to the amplifiers. We can again see the output channels have been assigned in the rack; -

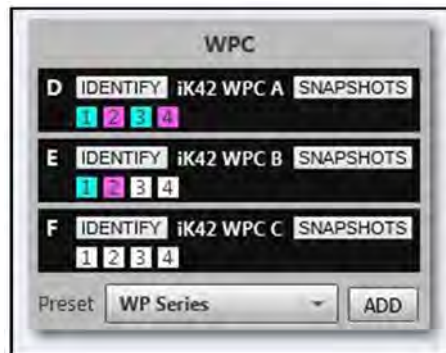

However, as the WPC is a bi-amp cabinet, alternate channels are colour coded light blue for low frequency, and pink for high frequency. Now repeat the process for the second array, the only change is to edit the input to Input 2/ DSP B as we are running in stereo; -



Load the settings and the rack is now fully populated; -

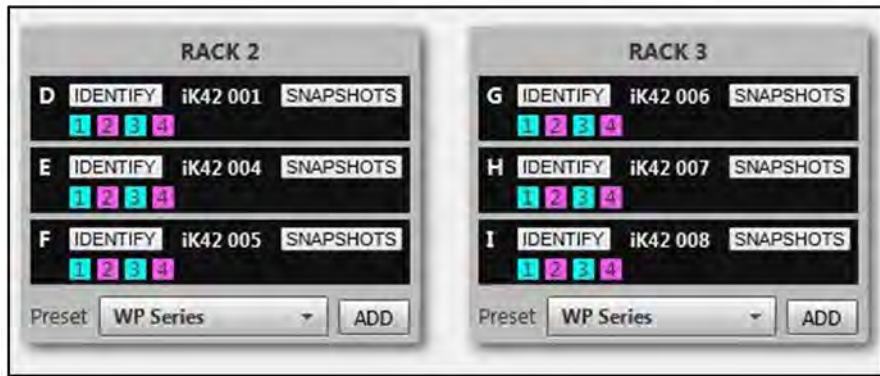

And we have a WPL Array thumbnail showing the amplifier channel routing; -



If we again take a look at the ganging window it gives us an excellent overview of how the system is configured; -

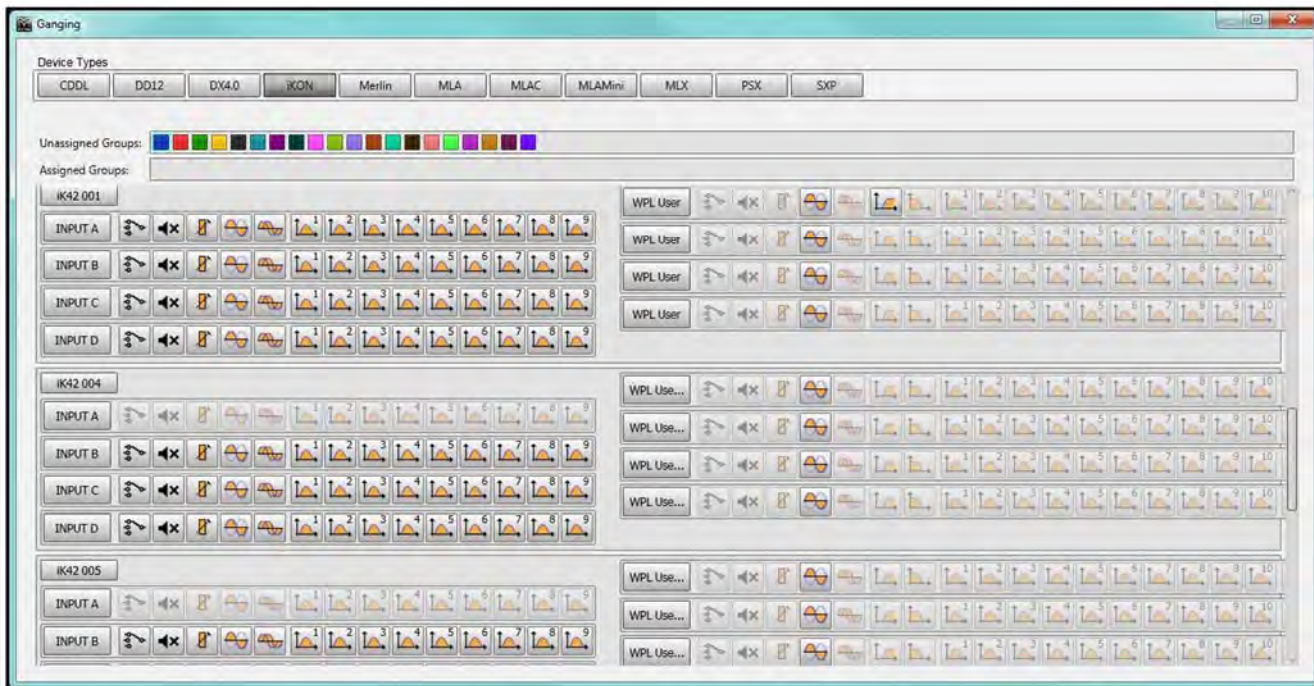

As before, input A on all i42 are internally ganged. All output parameters other than the polarity and high pass filter on the first output channels are greyed out. This allows the crossover point between the WPL array and the subwoofers to be set.

### MLA Mini

MLA Mini is usually sold as a package with the MSX sub which has on-board DSP and amplification to drive four MLA Mini. In this configuration d2p files created using Display 2.3 are uploaded to the MSX using the Preset Loader (See the Preset Loader chapter). It is also possible to power MLA Mini using an iK81 if a rack mount amplifier is a more attractive solution for any given application. Note that as MLA Mini is bi-amped you will need an iK81 for every four Mini cabinets.

MLA Mini optimisation files are loaded in exactly the same way as Wavefront Precision selecting the MLA Mini option using the drop-down menu; -



Click "ADD" to open the MLA Mini Preset Loader; -



MLA Mini also has the option of presets for front fill, either single cabinet or double and as with Wavefront Precision you can use the Emergency Default. None of these require an optimisation file; -



To load a d2p file, navigate to where it is saved on your PC, select the Mini array if there is more than one array in the Display project export and the Preset Loader appears like this; -



The optimisation will load from the first available amplifier channel (G1 in the above example) but this can be changed using the up and down arrows. The output channels will be assigned sequentially unless we choose to route them ourselves by pressing

the **'Manual'** button. We can change the Input or DSP channel and select Normal or flat input EQ. When we are happy with the destination selections for the optimisation we select **'Load'**. If we were setting up a stereo system we can load the same optimisation into a second iK81. The amplifier in Preset Manager will appear like this; -



The colours represent light blue for the channels driving the cabinet low frequency and pink for the channels driving the high frequency. Thumbnails to represent the MLA Mini will appear both in the Preset Manager Window and the Vu-Net System Diagram; -

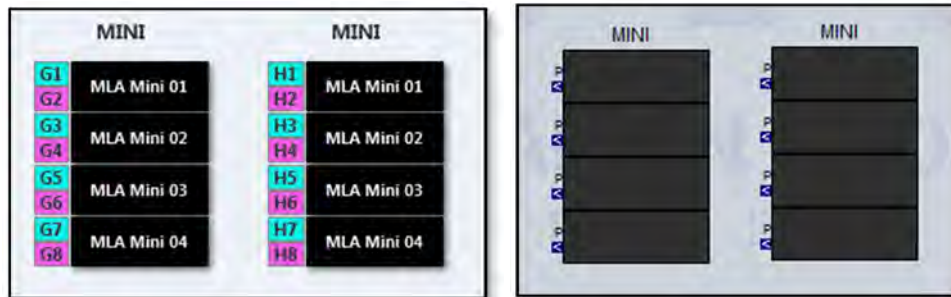

**O-Line**

O-Line optimisations can also be uploaded to an iKON amplifier in exactly the same way. Select O-Line in the drop-down menu in Preset Manager and click **ADD**; -



Click Select to navigate to your optimisation d2p file; -



In the example above we have an 8-box array which has been optimised at 2-box resolution meaning two cabinets per channel and therefore once loaded this will use four channels of the iK81. The optimisation will be loaded into the next free amplifier channel- I1 in the above example. This can be changed using the up and down arrows on the **Load From** box. The optimisation will load sequentially starting with the uppermost cabinets working down to the bottom cabinets. If you need to change this you can click on **Manual**; -



You can change the default channels to wherever you need using the up and down arrows either side of the Output boxes for each channel.

We can also change the input and DSP channel. You can select the input EQ applied from either Normal which is the standard EQ curve for O-Line, flat which overwrites and existing EQ or Preserve which will retain any EQ you have already programmed. When we are happy with the input selections click **Load** to upload the parameters to the amplifier.

If we are running a stereo system we can upload the same optimisation. By default it will load from channel 5. All we need to do is change the input channel to 2. The DSP channel will default to B; -



Once loaded our amplifier will appear like this; -



We will have thumbnails for the arrays in both the Preset Manager window and System Diagram; -

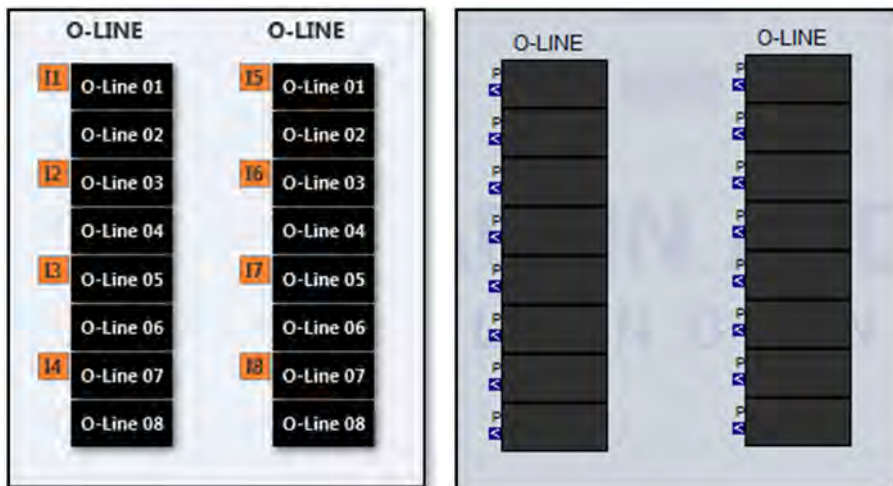



### User Presets

Presets can be created yourself for any product for which factory presets are not available. These can then be used as required when programming a system in future. A good example would be creating presets for Martin Audio legacy products. To demonstrate we will create a preset for a W8LC on an iK81. The W8LC is a tri-amp enclosure so first we need to add the correct parameters to three channels in the iK42 and route them from a single input. Note that for W8LC arrays you may need to create up to three presets as there are differences to the parameters for the cabinets depending on their position in the array. Parameters for all Martin Audio products including legacy ranges no longer manufactured can be downloaded from the Martin Audio website from the Loudspeaker Settings page accessed from the Support menu.

Here we can see the parameters entered into the iK42; -

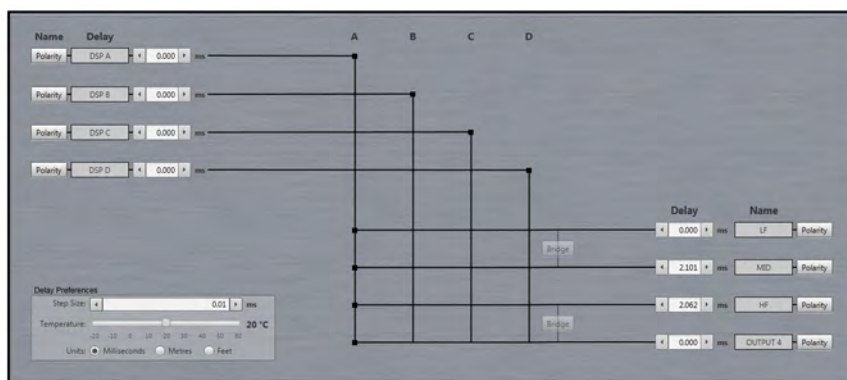
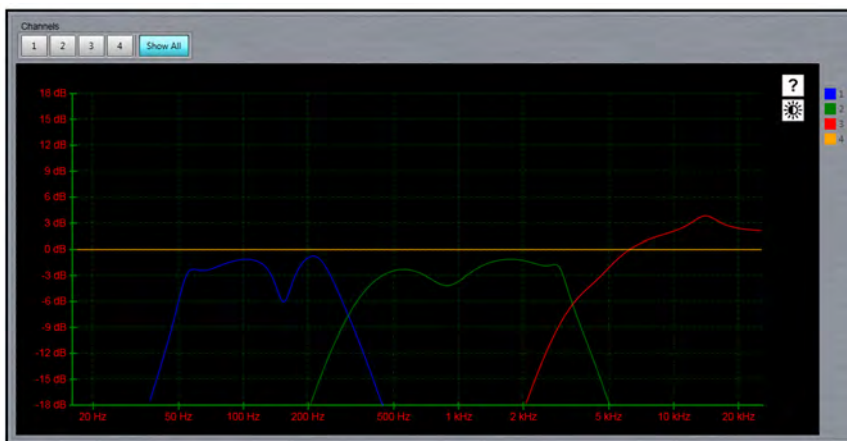

The DSP parameter settings are as follows:

Parameter	DSP A	DSP B	DSP C	DSP D	LF	MID	HF	OUTPUT 4
Mode	NORM	NORM	NORM	NORM	NORM	NORM	NORM	NORM
Threshold V	94.80	42.40	29.70	110.00	6.00	0.00	-1.00	0.00
Overshoot dB	3.00	6.00	8.00	8.00	6.00	6.00	8.00	8.00
Frequency Hz								
Threshold Hi dB								
Overshoot Hi dB								
TMAX								
Threshold V	67.00	30.00	21.00	110.00				
Attack s	12.00	2.00	0.80	34.00				
Release X	2.00	4.00	4.00	2.00				
XMAX								
Threshold V	208.93	208.93	208.93	208.93				
At Frequency Hz								
Min Frequency Hz								

Now open Preset Manager and click on the Export Preset button at the bottom of the window; -



The Preset Export window appears; -

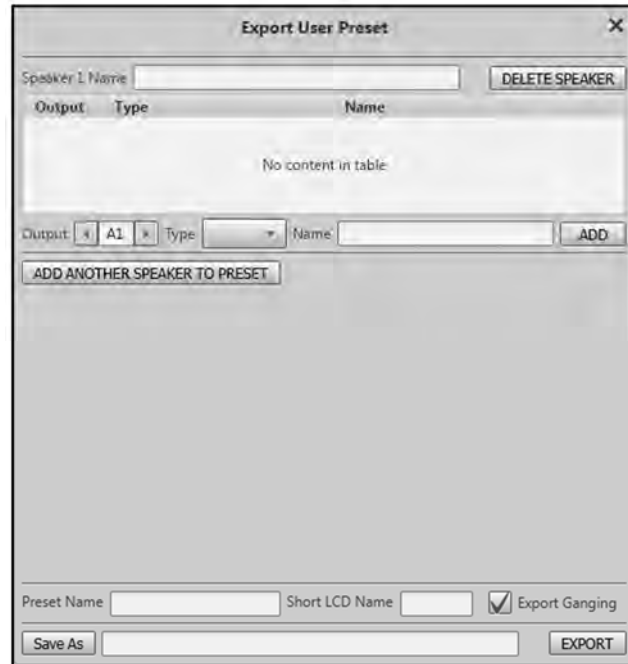

First name the Speaker, in our example W8LC. Now use the Type drop-down box to select what output A1 will be driving, in our case LF. The name will default to the speaker name with "LF" added. This is usually acceptable but can be over-written if required. Now click **ADD** and the first element is added; -

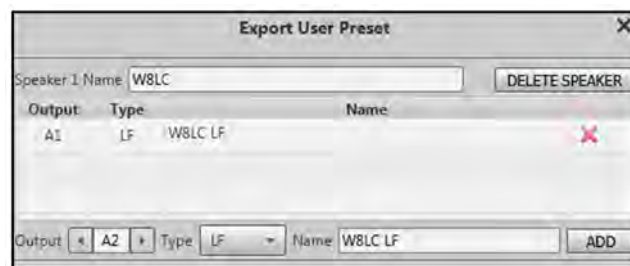

The output selection now jumps to the next channel. Change the output type to "MF", accept of re-name the output and click **ADD**. Repeat with HF for the third channel; -

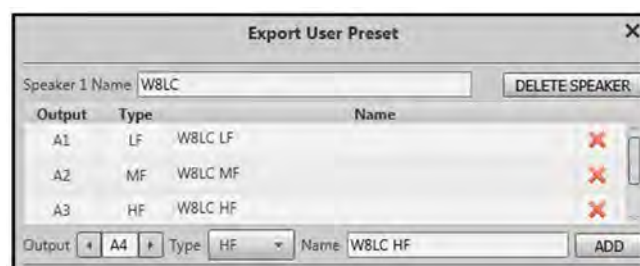

We can add a second speaker to the preset by clicking **ADD ANOTHER SPEAKER TO PRESET**. This would be used if you were creating a preset comprising a sub and mid-high speaker; -

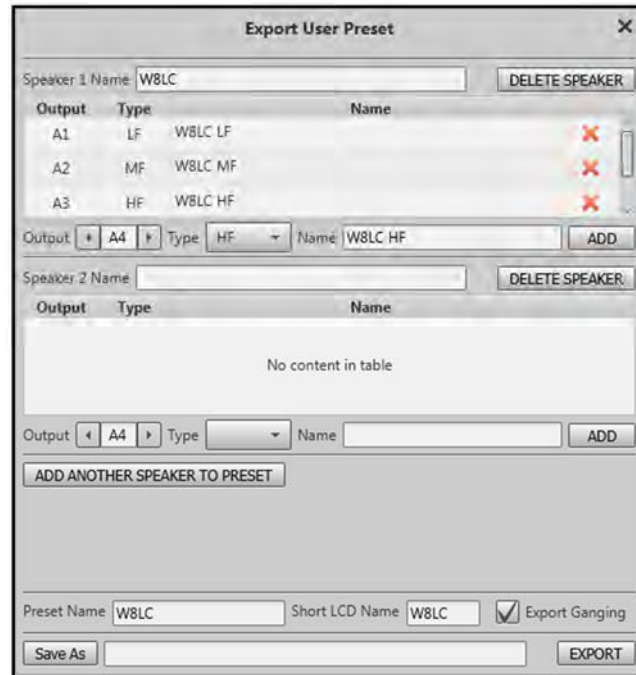

Follow exactly the same process to add the channels used for the second speaker. This is not required for our preset so we can click on **DELETE SPEAKER** to remove the second section. At the bottom of the window we can give the Preset a more descriptive name and an abbreviated version what will appear on the iK42 LCD display. If as mentioned we were creating three W8LC presets we could name one as follows; -

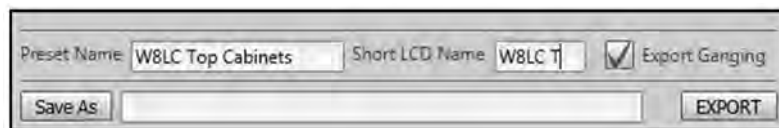

Now click on **SAVE AS** and navigate to a suitable file location on your PC in which to store the file and click **EXPORT**. The file will be created and you will see this window; -

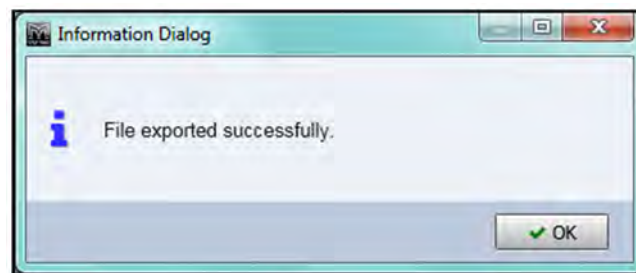

You will also see in the Preset Manager window that a speaker thumbnail has been added and the iK42 channels colour coded to show that they are driving LF, MF and HF; -



Now we can go to another amplifier and select **USER PRESET** from the drop-down selection and click **ADD**; -



Click **Open** and navigate to the file location where the W8LC Preset file was saved. The preset can now be added to the amplifier in exactly the same way as a factory preset; -





### Snapshots

Vu-Net can manage snapshots which are stored within each amplifier to allow up to 20 configurations to be stored and easily recalled for any common applications where the same settings may be required. As well as storing a complete overview of any single amplifier there is also the ability to store the channels used in an array configuration, even if these are spread across several amplifiers as is likely to be the case when running larger WPC systems for example.

Snapshots are accessed from the Preset Manager window. Each amplifier has a snapshot button; -

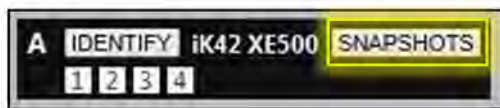

And the Preset Manager Window has an Array Snapshot button; -



If we look at the following example, we have two iK42s and one iK81, the iK42s are driving a single array of 8 WPC with two box resolution (therefore using all available channels on both amplifiers). The iK81 is driving an 8 box array of WPM at two box resolution which will use four channels. The other four channels are driving SX118 subs. If we open the Preset manager this is the window we see; -

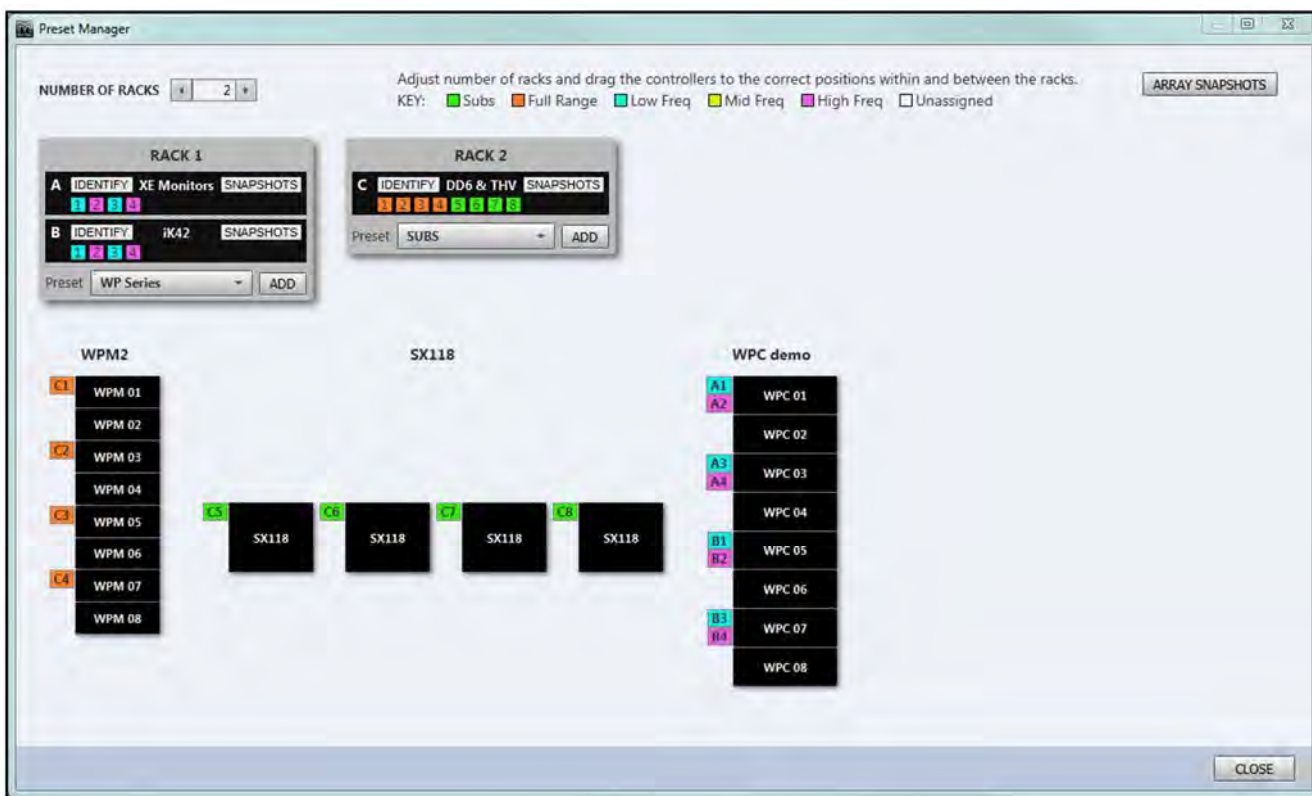

### Amp Snapshots

If we click on **Snapshot** on the iK81, the Amp snapshot window opens; -

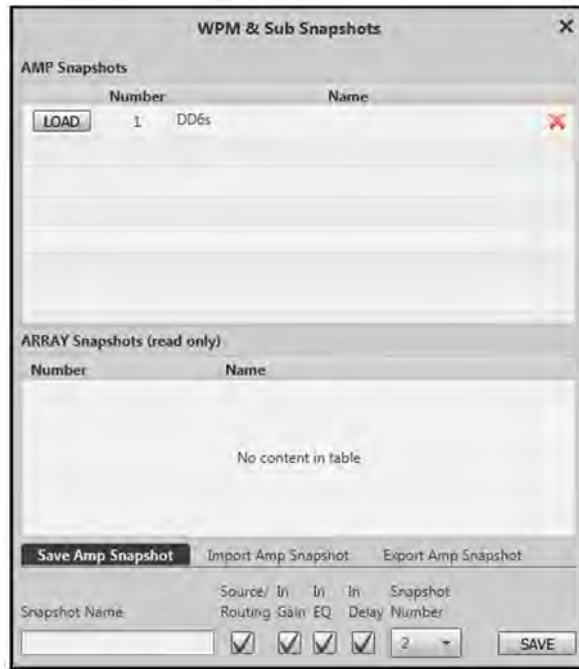

This shows that the amplifier already has a snapshot stored in location 1 to drive DD6. We can create a new snapshot by typing in the Snapshot Name Box.

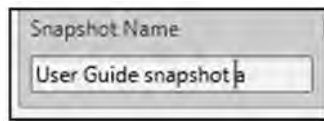

Next select which parameters are to be stored; - Source/routing, Input Gain, Input EQ and Input Delay (output settings are always included).

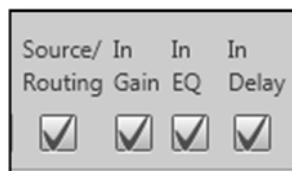

Now select which location number to store the new snapshot. We can select snapshot 1 which will overwrite the existing DD6 snapshot, or choose any of the other 19 locations; -



Now click **Save** and the Snapshot will appear in the list of Amp snapshots; -

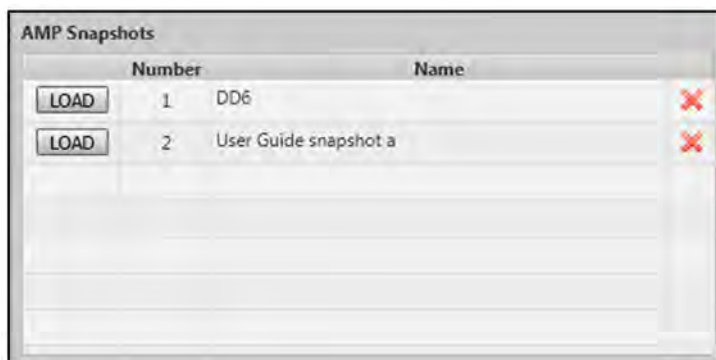

Note that any array snapshots that are stored in the amplifier will be displayed but are read only, you need to select the Array Snapshot button to store Array Snapshots. (See chapter on Array Snapshots)

It is also possible to Import and Export Snapshots to a file on your PC to build a library of snapshots. This is particularly useful if you need to save more than the 20 maximum that can be stored in the amplifier. To change to *Export Snapshot* use the option in the row towards the bottom of the Snapshot window; -



By default Save Amp Snapshot is selected. If we click on Export Amp Snapshot it will be highlighted and the bottom of the window changes; -

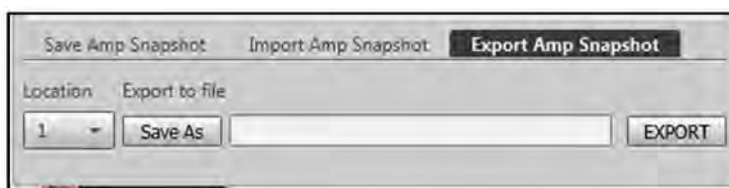

The first step is to select the snapshot you wish to export from the list available in the amplifier using the drop-down **Location** box. In the example above there are two available. Next click on **Save As** and navigate to a suitable location on your hard drive. Give the file a suitable name and click Save. Note that the file name is independent from the snapshot name. The Export section appears as follows; -

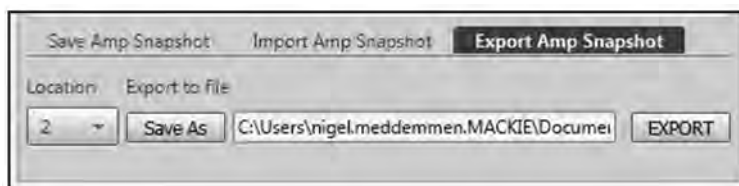

Finally click EXPORT and the file will be created and uploaded to your PC.

To Import a file, click on the Import Amp Snapshot tab; -

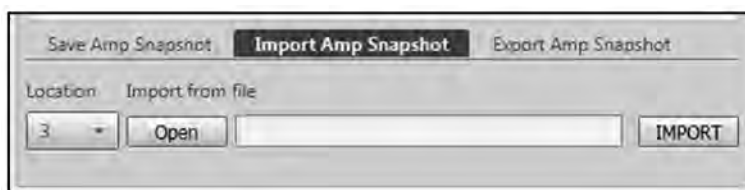

First select the Snapshot location into which you would like to store the file. It will default to the next free snapshot location but you can select a location that is already populated and the settings will be over-written with the parameters in the new snapshot;

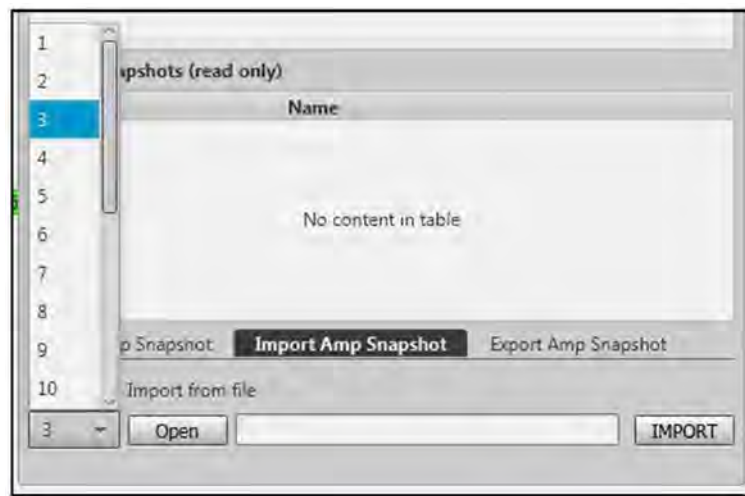

Next click **Open** and navigate to the file location on your PC where you have stored your snapshot file collection. Select the file you need and click **Open**; -



Now click **IMPORT** and the Snapshot will be stored to the amplifier and will appear in the Amp snapshot list; -



This can be loaded at any time as required. Any snapshot can be deleted by clicking on the Delete X on the right side of the window; -







### Array Snapshots

Array snapshots give you the option to store a snapshot which includes all channels used in an array including arrays that may include multiple amplifiers. It will also store an array snapshot that may not use all of an amplifier's channels, ignoring the remaining channels. This is useful for comparing optimisations for an event. A number of optimisations can be tried using Display 2.3, perhaps to compensate for changes in environmental conditions during the day at an outdoor festival- the temperature and humidity when a festival starts around midday in summer will be very different to the conditions late at night when the headliner is finishing their set. This will have a highly significant impact on sound propagation through the air which can be compensated for by the optimisation. You could very easily save three or four optimisations with slightly different temperature and humidity figures to reflect how these change during the day. They can be uploaded to the amplifiers and each version stored as an array snapshot. These can be very quickly recalled during the day to maintain the coverage exactly as planned without any variation, something almost impossible to achieve with a conventional system.

Note that each amplifier has 20 snapshot locations in total which can be *either* amplifier snapshots or array snapshots.

In the example we have a rack of two iK42 driving a single WPC array. We can store an array snapshot in these amplifiers. Click on **ARRAY SNAPSHOTS**; -

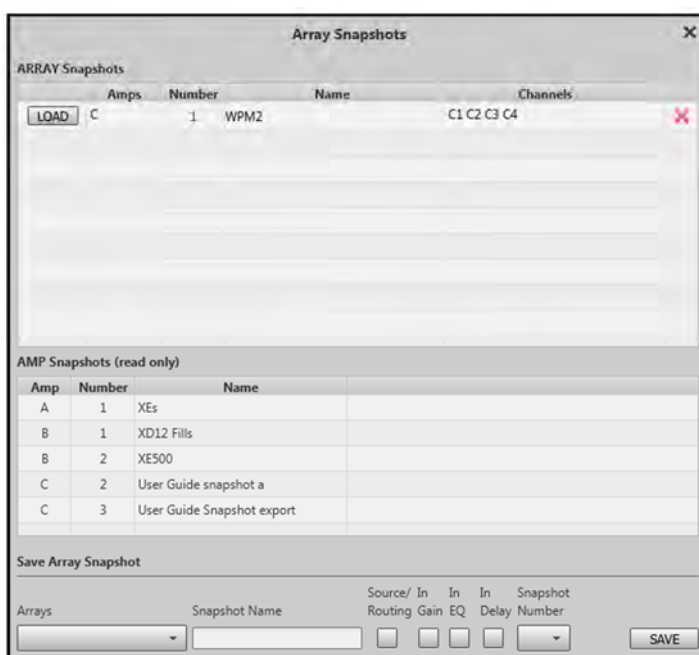

The top section shows all existing Array Snapshots, in this example, Amplifier C has an array snapshot in location 1 which uses four channels, C1-4.

The lower section shows all Amplifier snapshots. In this example, amplifier A has one snapshot for XE Monitors, amplifier B has two, one for XD12 and one for XE500, and amplifier C has two "User Guide" snapshots.

To store an array snapshot, click on **Arrays** at the bottom and use the drop-down to select which of the arrays in your project you wish to save by clicking in the check box; -

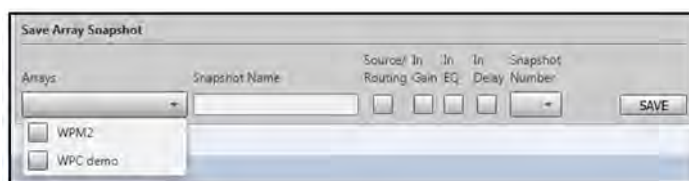

Give the snapshot a name and select which of the input parameters you would like to include in the snapshot, you can click on Source/routing, Input gain, Input EQ and Input delay independently. Use the **Snapshot Number** drop-down to select a snapshot

location. This will default to the next snapshot location that is clear on all amplifiers driving the array. In this example as amplifier A has a snapshot in location 1 and amplifier B has snapshots in locations 1 and 2, the next available location is 3; -



Click **SAVE** and the array snapshot is stored and appears in the list in the upper section of the array snapshot window; -

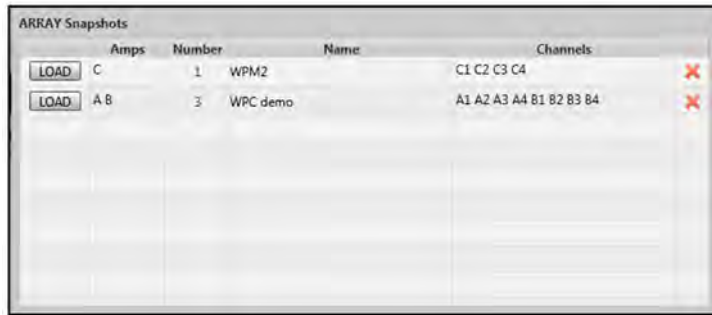

If we take a look at the Amplifier snapshots for the two iK42s we can see how the Array snapshots are displayed along with the amplifier snapshots; -

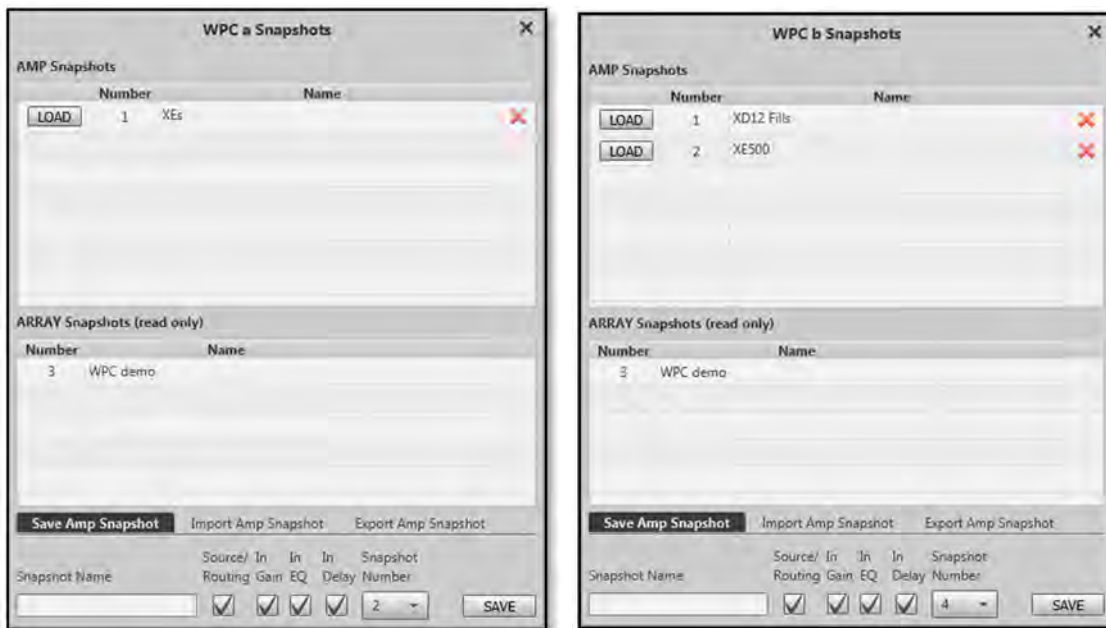

The top section shows the amplifier snapshots in each amplifier. The array snapshot appears in the read only window to show that the location (3 in this example) has been used and is no longer available. Note that when saving a new amplifier snapshot you cannot overwrite an array snapshot, to use the location which has been used for an array snapshot it is necessary to delete the whole array snapshot from the Array Snapshot window using the delete button; -



## Loading Multicellular Presets

Once an array has been discovered and tested, the next stage is to upload the optimisation file that has been created using Display 2. This is done using the Preset Loader which is found in the Tools menu; -

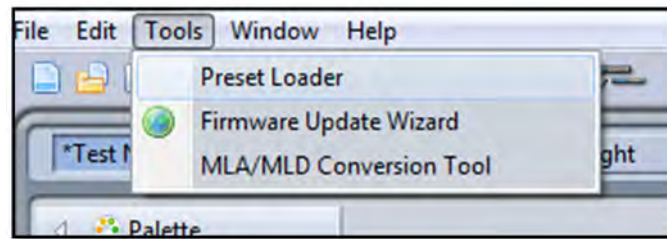

This brings up the Preset Loader window. In this example we have a small MLA system with two 6 box arrays; -

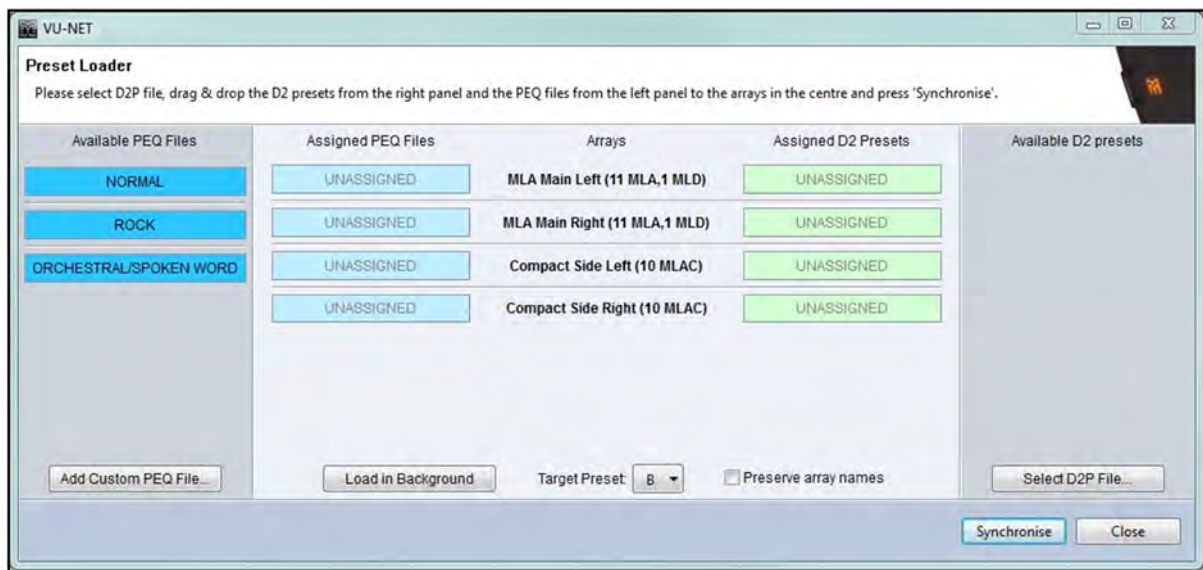

There are a number of options available but particularly when loading the first preset into an array the first step should always be to click on 'Select D2P File' to navigate to wherever you have saved the D2P file saved when you did your Display 2 optimisation; -

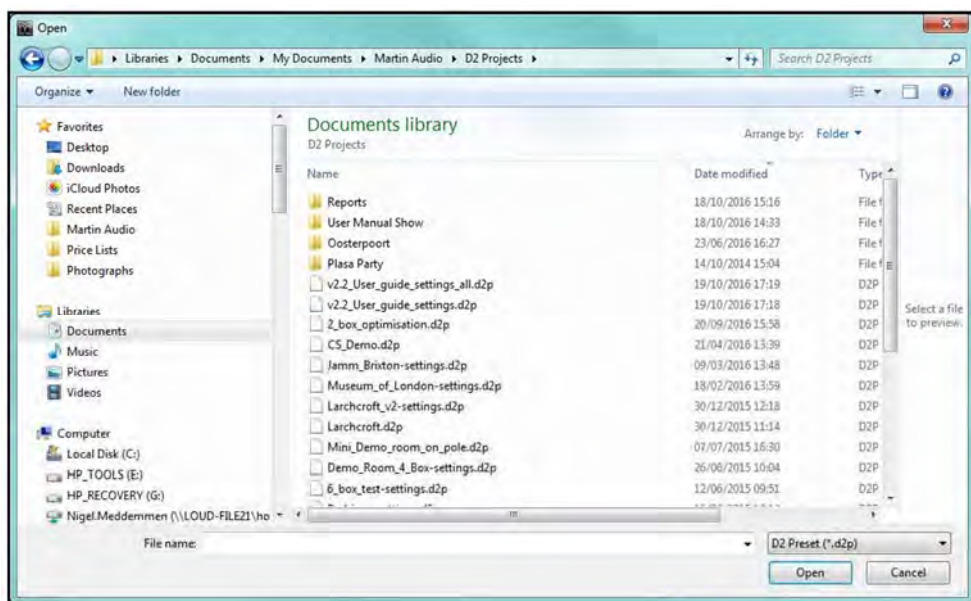



It is essential that you select a d2p file which matches the array configuration size and type that matches the array to which you wish to upload optimisations. You cannot load a non-matching d2p file!

There are a couple of possible outcomes when you have selected a d2p file. If you have only created one optimisation for your project it will be automatically placed in the array thumbnails ready for synchronisation. In the above list of d2p files, "v2.2\_User\_guide\_settings.d2p" is an example of this. Note that the optimisation will always specify the type of cabinet, in this case MLA. You will be able to select any d2p file but will not be able to synchronise a file created for the wrong type of cabinet. The Window will appear like this; -

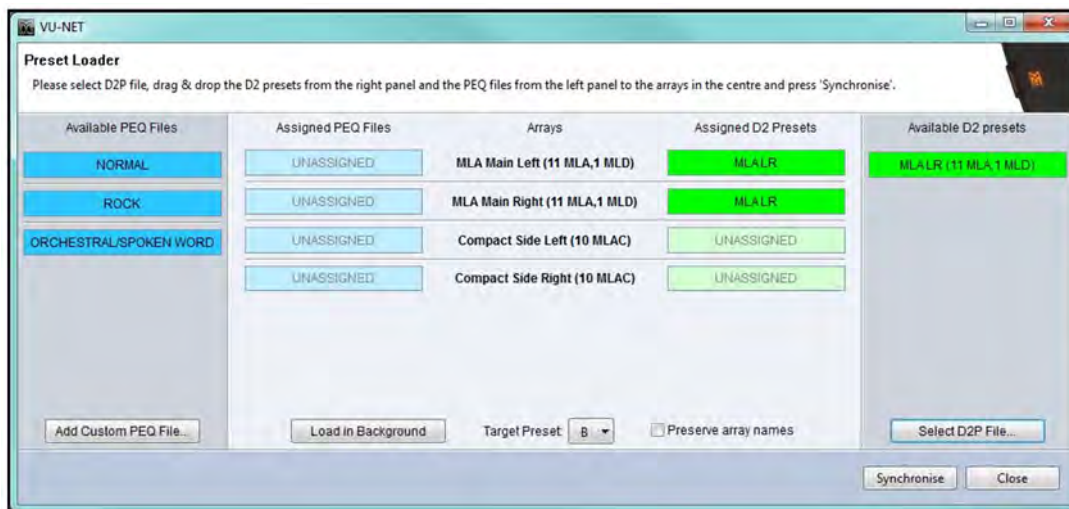

You can see that the optimisation contained within the file called "Main LR" appears in the Available D2 presets list on the right. It is also already showing in the Assigned D2 Presets for both of the Main left and right arrays in our system.

If we created several optimisation for the array, trying a few different goals for example which was done in the file "v2.2\_User\_guide\_settings.d2p\_all" in our examples, this is how the window will appear; -

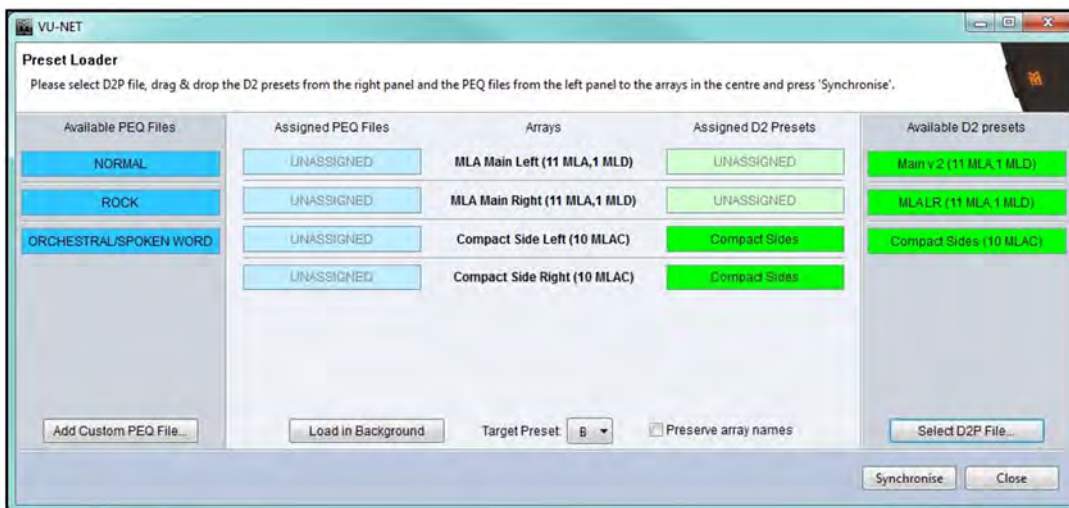

This example has three optimisations contained within the file, "Compact sides (10 MLAC)" which has been immediately added to the two MLA Compact arrays as there is only one matching optimisation for the Compact side hangs. There is also "Main v2 (11 MLA, 1 MLD)" and "MLA LR (11 MLA, 1 MLD)". Neither of these have been added to our MLA arrays as they both match therefore we can make the choice of which one we would like to synchronise. At this point you are able to select which file you would like to use by simply clicking and holding with the left mouse button and dragging and dropping from the available list onto the Assigned Presets boxes. Note that you do not necessarily have to load the same optimisation into each array. In the following example, we now have main and side hangs of six cabinets, our d2p file is the same as the previous example and

contains two optimisations. We have dragged "User Manual 6 MLA" over to the Main left and right arrays, and "6 Box alt" over to the side hangs; -

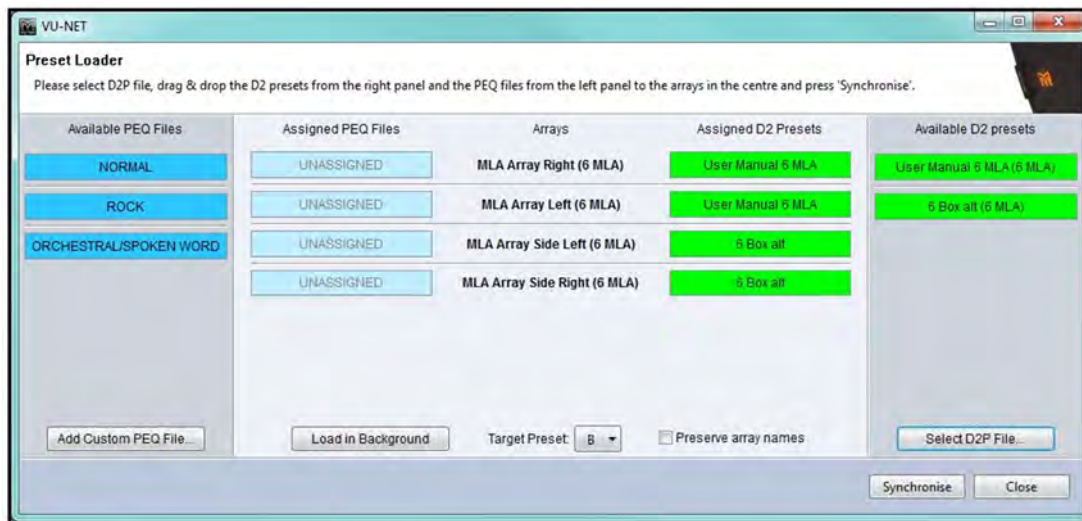

Note that as well as uploading the optimisation file to each array, optimisation files created in Display version 2.2 onwards also contain detail of the spl reference set during the design process, Vu-Net uses this information to make changes to the gain of the subs to maintain a good balance between the arrays and subs. These are the gain changes; -

- Optimisation reference of 110db or more: Sub Output Gain +10dB
- Optimisation reference 105dB: Sub Output Gain +5dB
- Optimisation reference 100dB or less: Sub Output Gain 0dB

**PEQ files**

On the left side of the Window you can see three available PEQ files, Normal, Rock, and Orchestra/Spoken Word. Note that the available list of PEQ files may change depending on the product, MLA Mini for example only has a 'Normal' PEQ available. These may also be dragged over to the Assigned PEQ file position; -

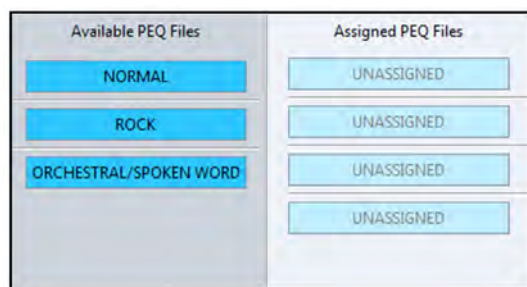

It is important to do this not only to add some tonal EQ to the system but the PEQ synchronisation also performs a reset function on certain parameters in the array. It matches the input setting for every cabinet in the array to the first enclosure and resets the array delay to the default setting. Here we have applied the Rock PEQ to all arrays; -

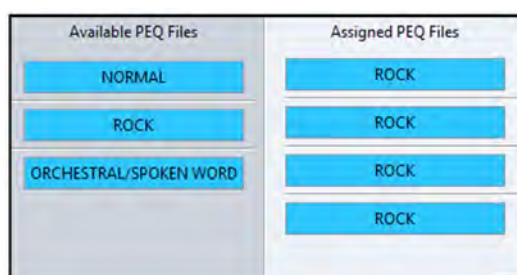

There is also the option to load a Custom PEQ file; -

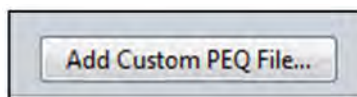

A PEQ file that has been created in an array can be saved as a file by right-clicking on the array in the System Diagram window. To up-load the file at the same time as synchronising Optimisations, click on the 'Add Custom PEQ File...' button and navigate to the file location where the .mlap PEQ file is saved. Click on the file and it will appear in the list of available PEQ files and can be dragged across in the same way as any other;

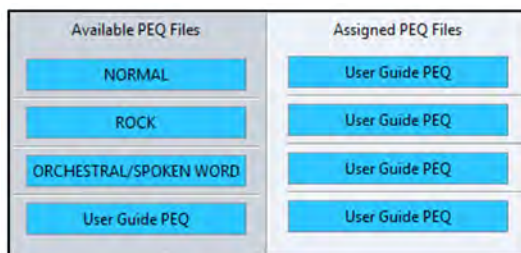

It is important to understand that a Custom PEQ will NOT perform the same system reset as one of the factory PEQ's so we would always recommend using a Factory PEQ for your first Sync and then add your own PEQ if you load any subsequent new Optimisations or use the right-click 'PEQ- Load PEQ' function in the array thumbnail on the System Diagram Window.

Note that you do not have to have the same PEQ applied to every array and if you wish to change the file prior to Synchronisation just drag the new file over to the array and it will replace the existing file type; -

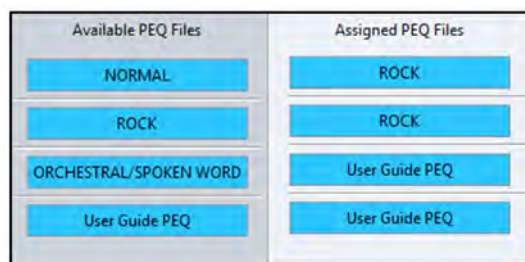

Note that Optimisations created using Version 2.2 onwards contain version information that Vu-net uses to make subtle changes to the default EQ curves loaded.

### Other options

There are some other options available in the Preset Loader. From right to left you will find 'Preserve array names'; -



If you have already named your arrays check with box prior to synchronisation. Without it the arrays will be renamed with the same name as the D2 optimisation.

Target snapshot allows you to select the cabinet snapshot into which an optimisation will be loaded; -

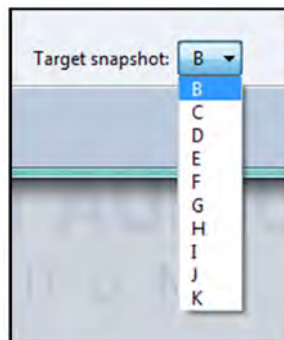

There are ten available labelled from B to K. A is the default factory preset with basic box EQ which may be used whilst checking a system or in an emergency, all other are available for your optimisations and once uploaded can be selected in a few seconds. Select the desired location using the drop down button.

Load in Background is very useful for uploading new optimisations after your first files have been synchronised. Clicking on the Load in Background button removes the PEQ options and the window appears as follows; -

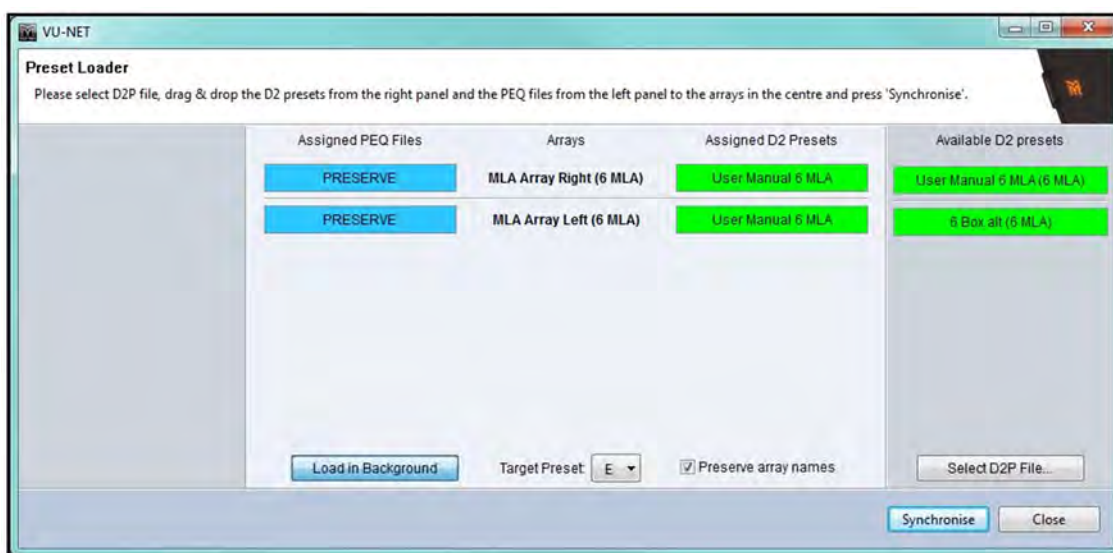

The PEQ already uploaded will be preserved and if you select an alternative snapshot to the one currently being used you can even synchronise while the system is in use. It will synchronise in the background as the name suggests without disturbing system performance and you can then wait for an appropriate break in a show or rehearsal to select the new snapshot.

## Synchronise

Once you have completed your selection of the available options, the final step is to click on the Synchronise button to start the Preset upload. You will see a series of Windows that show the process of the upload including the following; -

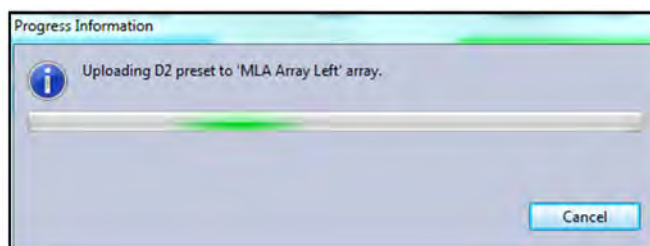

The presets are loaded to each array in turn, in our example first the left array. The optimisation is then stored in a snapshot; -

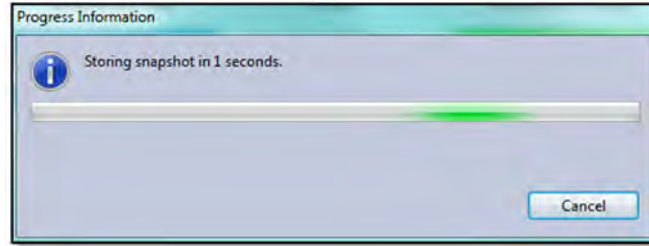

The snapshot will be recalled; -

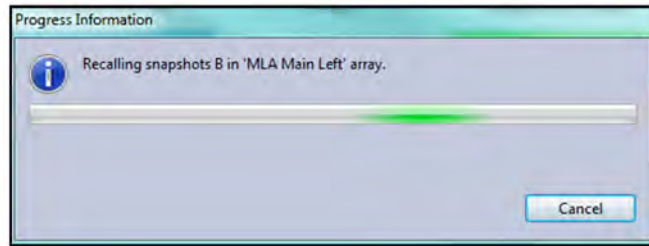

The PEQ's will be loaded. This step will not take place if you selected 'Load in Background'; -

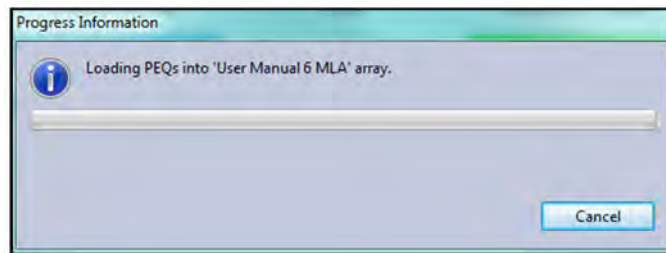

It will repeat these steps for all arrays on the network. Once finished you will see this window; -

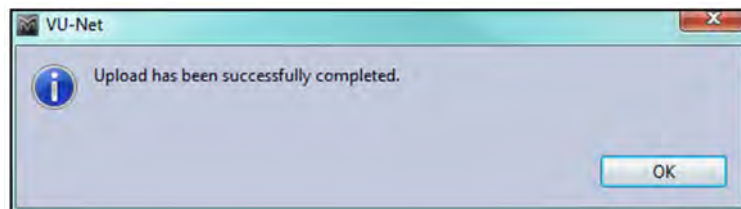

You can then close the Preset Loader. It can be re-used whenever you wish to upload new optimisations. In particular if you have created several optimisations for an array in the same D2P file or independently, just repeat the Preset Loading process selecting the same D2p file but dragging the alternative optimisations into the array. Select the load in Background option as there is no need to keep uploading PEQ files, and select a different target preset. Once uploaded you can compare your optimisations by selecting the different presets by right-clicking on the array thumbnail and choosing the 'Load Preset' option.



## Master Overview

Vu-Net features a Master Overview window intended for use following set-up when it is useful to view the entire system on a single page with the ability to monitor all levels and make changes to essential functions.

Here we see a project with a variety of U-Net enabled devices connected including an array of one MLA and an MLD, a flowm MLA Mini system, a PSX, DDD12 and a Merlin; -

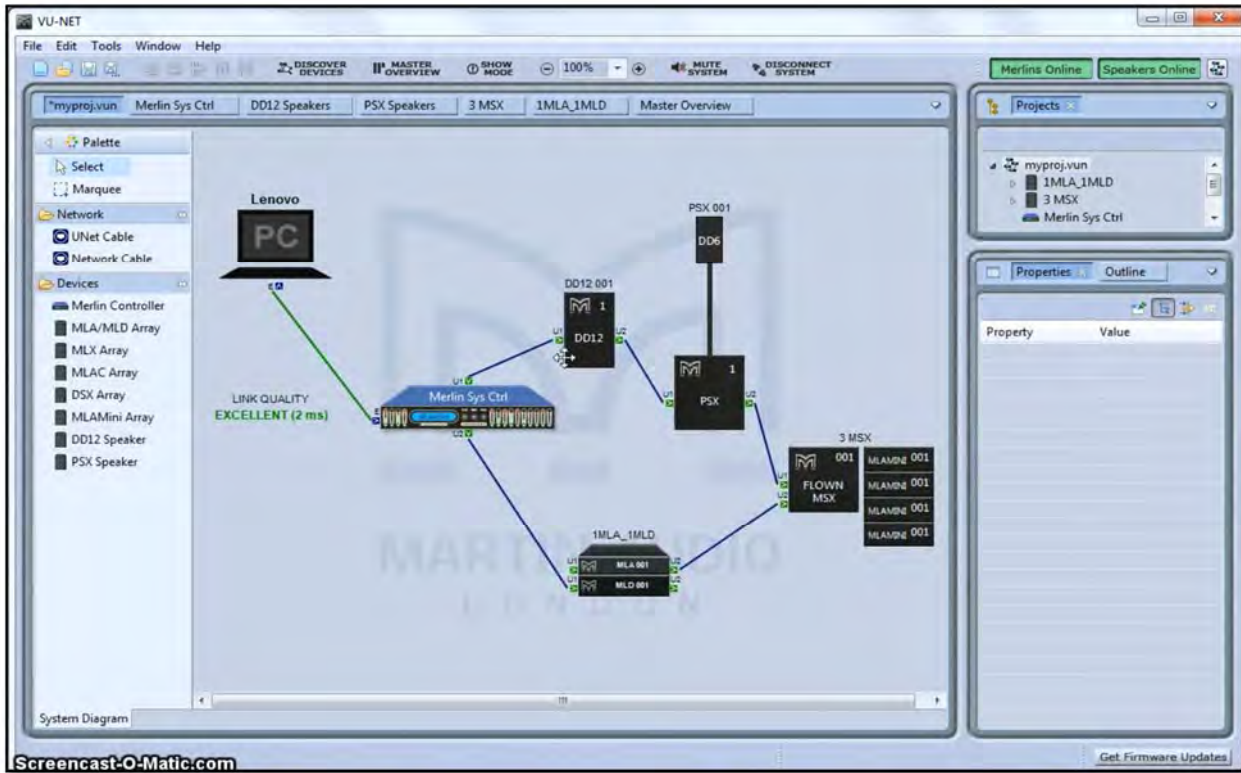

If we click on the Master Overview button; -



A new tab is opened with a window showing all devices in operation; -

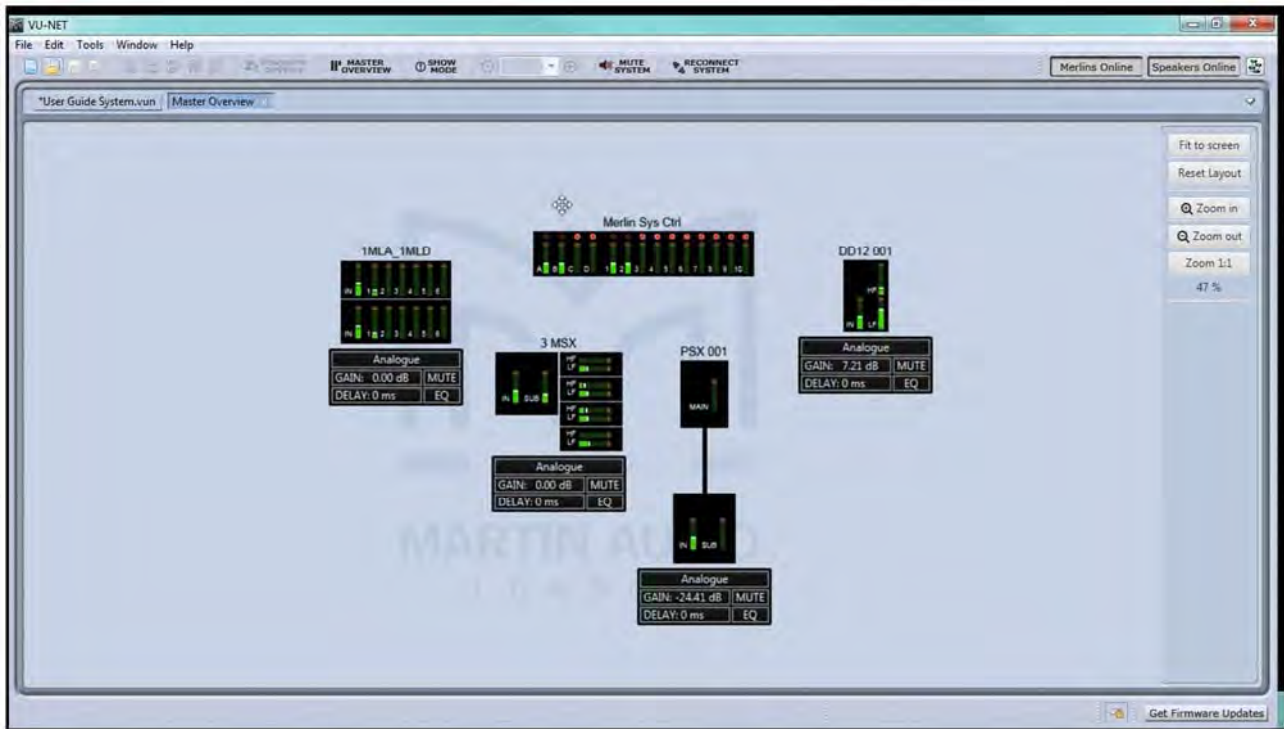

The MLA array shows the input bargraph plus all Cell output bargraphs for all cabinets in the array, all other arrays and speakers show input and output levels and all Merlins display input and output meters. All bargraphs are updated in real time which makes monitoring an entire system very easy from a single page.

In addition to monitoring the meter response, essential features are accessible. The function control is the same for all Array and speaker types; -



The top line shows the input configuration for the array, if this needs to be changed clicking on the top line takes you to the array input overview screen where you can change the input configuration. If the array isn't already open it will be opened by clicking on this button.

On the second row is GAIN. Gain adjustments can be made by clicking on this button. A pop out fader appears which can be adjusted in real time, either by dragging and dropping the fader knob until the desired gain value is displayed,

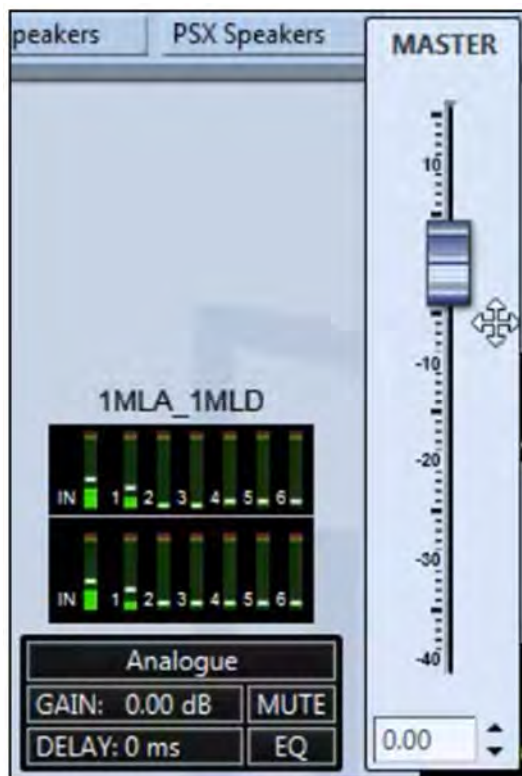

Using the up/down arrows to adjust the gain up or down in 0.1dB increments; -

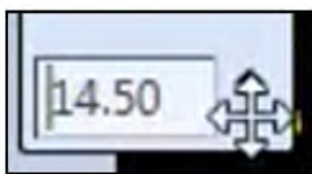

Or by directly typing the gain figure you need; -

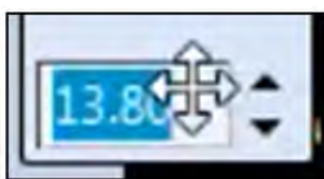

A click anywhere in the Master Overview Window away from the gain control will close it once you have made any necessary adjustments.

Next to the gain is Mute, clicking on this will mute the array and the button will turn red; -



Note that when in Show Mode a pop-out Window will appear to confirm that you want to mute the array.

Clicking on Delay opens a pop-out window showing the gain figure with a series of arrows for adjustment; -



Clicking on the arrows will adjust the delay up or down by either 100's, 10s, individual or tenths of a millisecond making it very quick and easy to enter a precise figure. As with gain, clicking anywhere else once you have completed adjustments will close the window.

The Window for PSX is slightly different in that it has individual delay adjustment for both the sub and main outputs; -

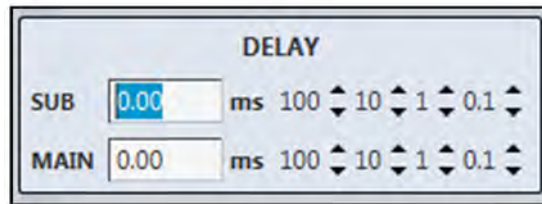

The EQ button will take you directly to the EQ Window for the array, opening it in a new tab if it is not already present.

Double clicking on Merlin will also open it in a new tab, the tab on view will be the last tab that was in use if the Merlin has already been opened, or the Gain/Mute/Limiters tab if it is not already open.

The layout of the Master Overview screen will by default show the arrays in size order. This will automatically re-size to ensure that all elements fit in the window. Elements can be dragged and dropped to arrange the system to your requirements. A series of buttons and a display on the right hand side of the window allow adjustment of the view and shows the current zoom; -



'Fit to screen' offers a quick method of re-sizing the window to ensure that all elements are visible.

'System Layout' will move all elements to match the layout in the system diagram, If you moved all devices during set-up in the system diagram to represent their actual physical positions around the venue default, clicking on this button will duplicate your layout in the Master Overview.

You can choose to return to the default Auto layout by clicking the Auto Layout button, this will bring up a confirmation window

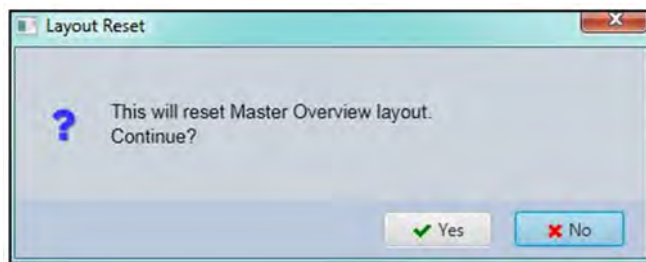

Clicking 'Yes' or pressing Return will reset the layout to the default and the display will confirm the new zoom and that Automatic layout has been activated; -

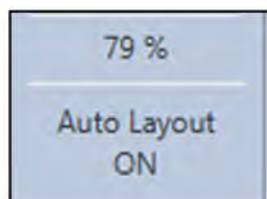

As soon as you move any elements or zoom in or out the Auto Layout will disappear.

The Zoom in and out buttons will change the zoom in steps of 10% up or down. This can also be achieved if you have a mouse connected with a scroll wheel. Zoom 1:1 restores the window to 100% regardless of whether any elements will be outside of the view.

## Show Mode

Show mode is designed to offer a degree of protection once set-up is complete and a show has started to prevent the user from muting part of the system accidentally. With Show Mode inactive during set-up, all mutes can be used as and when required with a simple mouse click; the array will mute and unmute instantly under command of the button. When Show Mode is activated, clicking a Mute button anywhere in the system will bring up a confirmation window; -

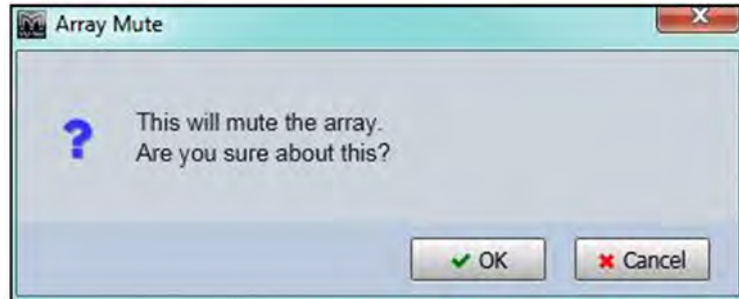

The window is slightly different for a zone mute; -

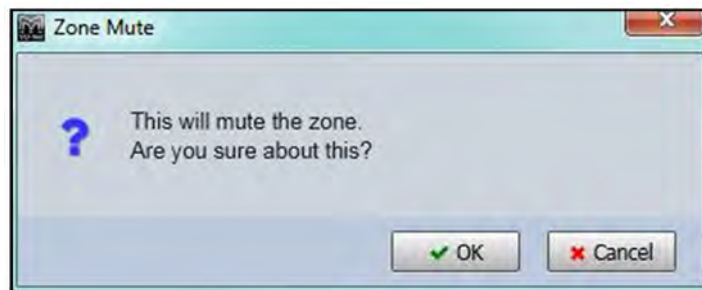

For a DD12 or CDD Live speaker; -

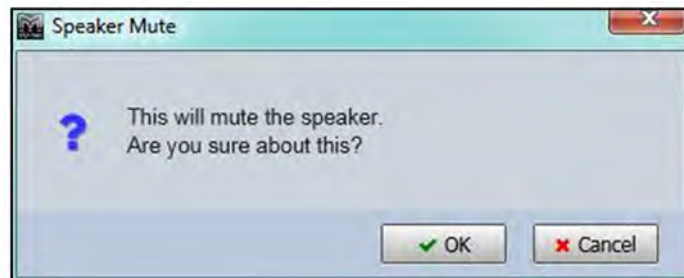

The Sub and main Mutes for the PSX have different mute messages; -

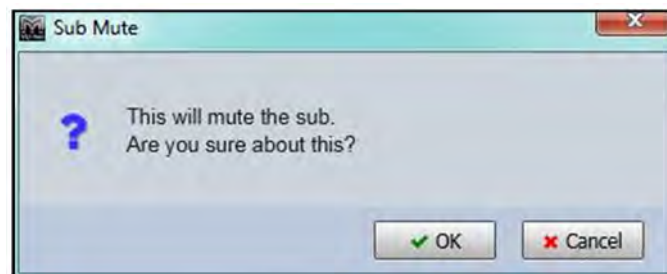

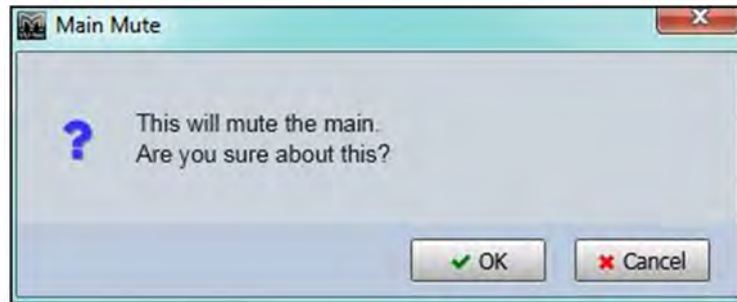

And finally the input and output channels on a Merlin; -



If you definitely want to mute the array, zone or speaker, click 'Yes' or press Return. If you accidentally clicked on a Mute, click 'No' and the window will disappear with no change to the mute state.

Un-muting part of the system could also potentially be destructive so a similar message will prompt you to confirm the action; -

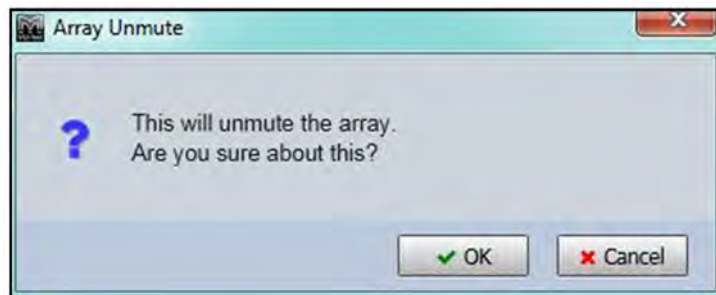

Note that the Master system Mute on the toolbar is not affected by Show Mode, as it is so destructive it always produces a prompt to verify that you wish to proceed.

The Output diagnostics for MLAS, MLA Compact or MLA Mini is also unavailable in Show Mode. Double clicking on the array thumbnail will bring up the following window; -

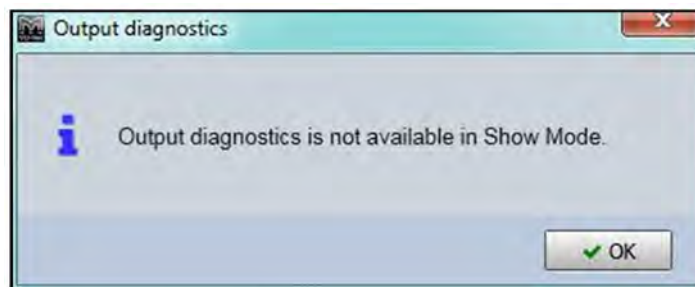

If an array has the diagnostics window already open before activating Show Mode, the Mute Array button and individual cell mutes for each cabinet will be unavailable, you will see the following window if you click on any of these; -

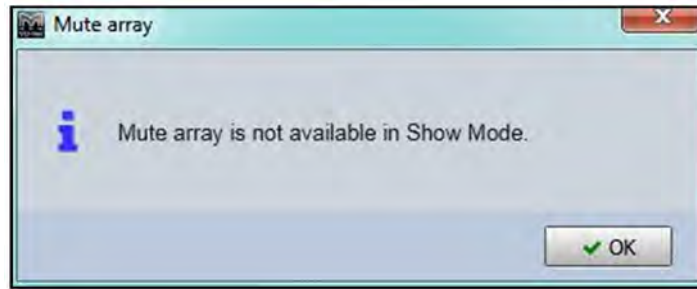

You will however be able to click on the 'Hide' button to close the diagnostics screen and any muted cells will be un-muted. You will not be able to go back to the diagnostics page until Show mode is switched off.



## Firmware Updates

Martin Audio is constantly striving to make improvements to the MLA family of products. The phenomenal processing power available makes them extremely future proof so as Martin Audio improve the optimisation capabilities of Display 2 or add additional functions to Vu-Net. The MLA Series will seamlessly run the improvements. Occasionally an update to the cabinet Firmware is needed which is catered for in Vu-Net using the Firmware update Wizard.

If you have sub-rented additional cabinets you may find that your rental partner has not been quite so diligent in keeping their system firmware up to date and device discovery will show some cabinets with differing firmware versions. In this instance it is essential to update firmware on the miss-matched cabinets, do not try to run a system with a mixture of firmware, it could cause compatibility

In common with many digital systems, a firmware update puts the product in a venerable state known as “boot mode”. It is vital that the firmware update is not interrupted by either a mains outage, cable disconnect or closing Vu-Net. Any of these could render the product unusable which may mean a return to Martin Audio for repair therefore you should take every possible precaution before commencing a firmware update. ALWAYS use a hard wired connection from your PC to the system, do not rely on Wi-Fi. Always use your PC with its mains PSU, do not rely on battery power. Try and ensure that your mains supply is reliable and is not likely to fail mid-update. Finally, the update process takes around 13 minutes per enclosure so on a large system is very time consuming. It is strongly recommended that firmware is checked when a system is prepped prior to a show back at your warehouse, it is not a task for set-up on a show day.

***Important: Be aware that a firmware update will leave the cabinet in factory default mode once complete. The Input will be set to analogue and any presets or EQ applied to the cabinets will be lost so will have to be re-uploaded.***

***Optimisation Presets should be uploaded in the usual way using Preset Loader.***

***If you have applied an EQ to an array that you need to retain, right click on the array and use "Export PEQ" to store the PEQ as an mlcp file which can then be re-imported once the firmware update is complete.***

***If you intend to use the system with an AES feed you will need to change the input to AES from Analogue.***

## Get Firmware Updates

To make sure that you are loading the latest updates Vu-Net includes a system for checking that you have the latest firmware files installed so they are available to upgrade your system. The files are held in a server at Martin Audio and are accessed over the internet so to get the latest files you will need internet connectivity to your PC. Note that you can get Firmware update files completely independently, you do not need to be connected to an MLA system, the simple method is to take the tablet PC supplied with your system to your office, connect to the web and check for updates. Note also that whenever new firmware is released you will be notified by e-mail.

The Get Firmware Updates button is in the bottom right corner of the Vu-Net window; -

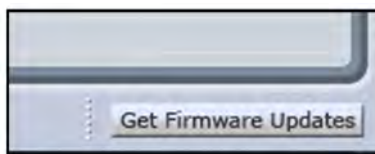

Click on the button and the following Window gives you three options; -

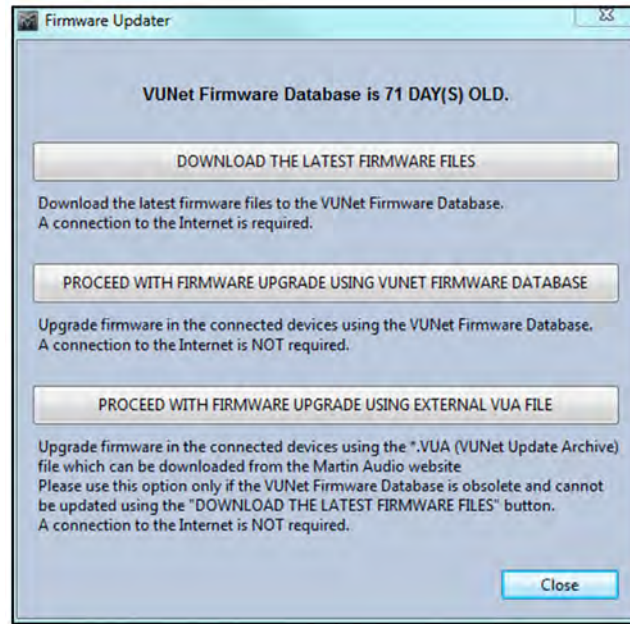

The first option as described accesses the firmware server via the internet. The URL for the Update file location is retained in the Vu-Net Preferences; -



Do not change this unless told to do so by Martin Audio!

Click on the 'DOWNLOAD THE LATEST FIRMWARE FILES' option and you will see the following window; -

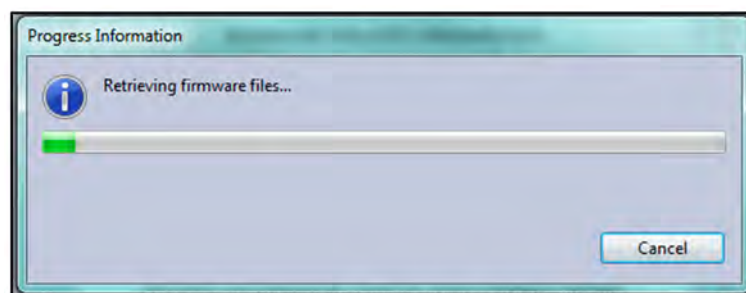

This is usually very rapid but depends on the speed of your internet connection. The latest files are now saved within Vu-Net ready for an upgrade. At the top of the Firmware Update window you will see; -

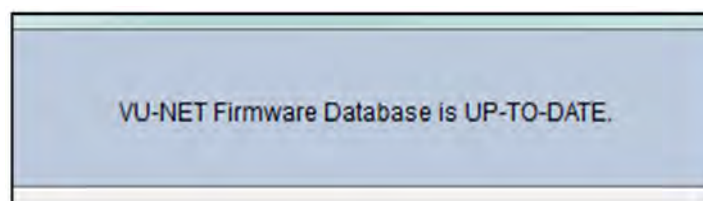

The Second option is to proceed with the update using the already installed firmware files. This is perfectly acceptable if you have already uploaded the latest files following a message from Martin Audio that there is a new release, or if you have periodically gone on line to load the latest files routinely. Clicking the 'PROCEED WITH FIRMWARE UPGRADE USING VUNET FIRMWARE DATABASE' button and the window closes and the Firmware Update process starts.

The final option is to update the Firmware using an external VUA file. If for any reason you are unable to update the Firmware database via the internet if it is impractical to connect the Tablet PC for example, but have access to the web on another computer, it is possible to download the firmware file and transfer it to the system Tablet via a USB drive or similar.

Clicking on the 'PROCEED WITH FIRMWARE UPGRADE USING EXTERNAL VUA FILE' button will bring up a file browser. Navigate to the drive where the VUA file is located, in this case on a Martin Audio USB Key; -

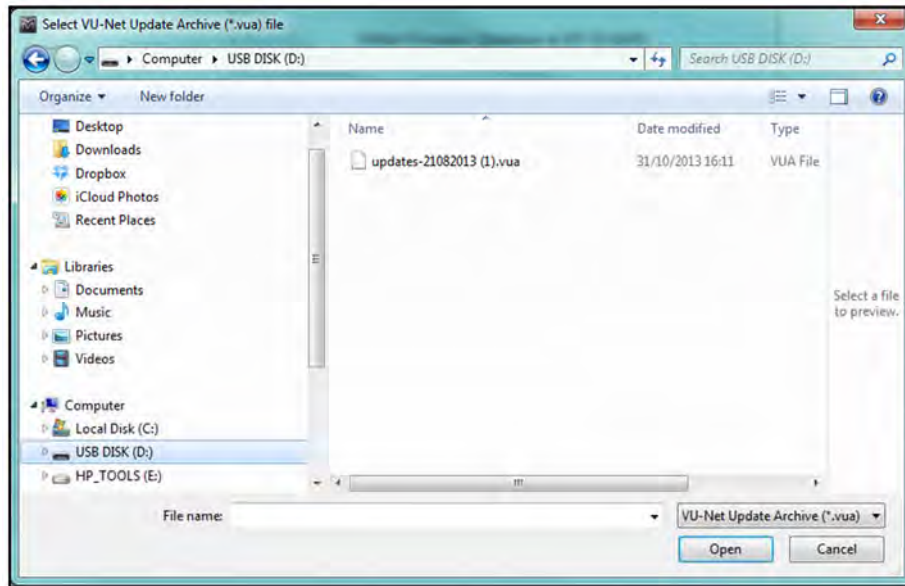

Select the VUA file, it will be saved and the update wizard will commence.

### Starting a Firmware Update.

Selecting the Firmware Update Wizard in the Vu-Net Tools menu opens the same window as the Get Firmware updates to double-check that you have the latest versions. Assuming that you have definitely installed the very latest versions you can click on 'PROCEED WITH FIRMWARE UPGRADE USING VUNET FIRMWARE DATABASE'. Vu-Net will scan the U-Net network for connected devices in the same way as a Device Discovery; -

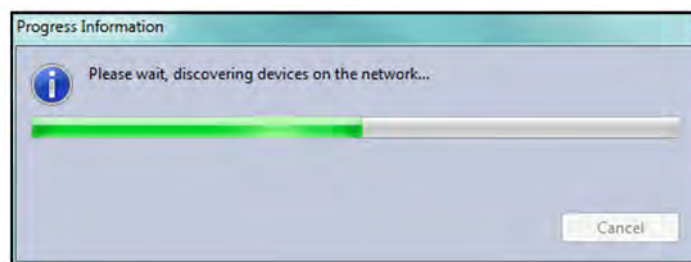

When the scan is complete, a window will appear with a list of all devices found together with their type, Serial number and the installed firmware; -

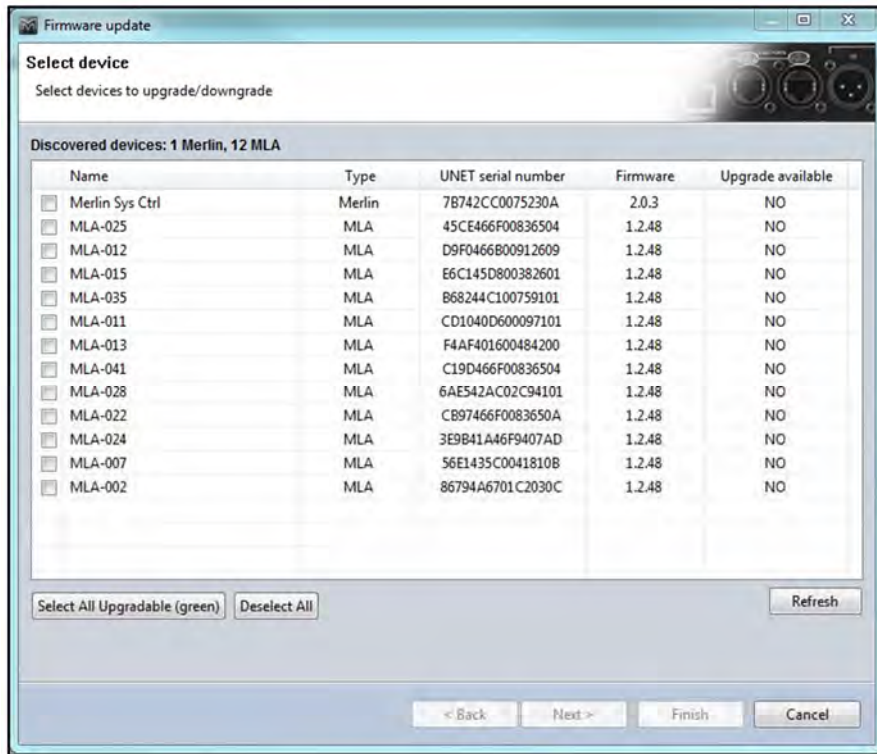

Vu-Net compares the discovered Firmware version with the latest version stored in its database and will indicate in the final column whether an upgrade is available. In this instance a single Merlin and twelve MLA have been found and all have up to date firmware however we can still proceed with an update to show how the process works.

In the left hand column there is a check box to select any device which you would like to update. The button at the bottom gives you the option to select all cabinets if required with a single click. If you have made an error in selecting devices you can use the 'Deselect' all switch to start again. We will do an update on the final two MLA; -

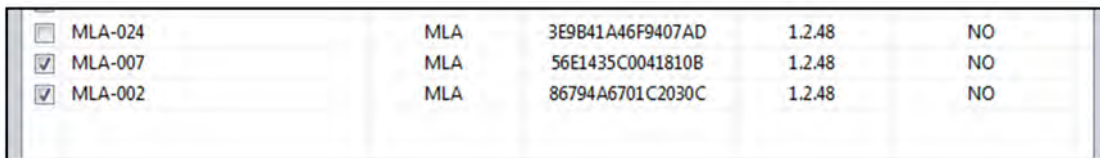

Click next and you see the following window; -

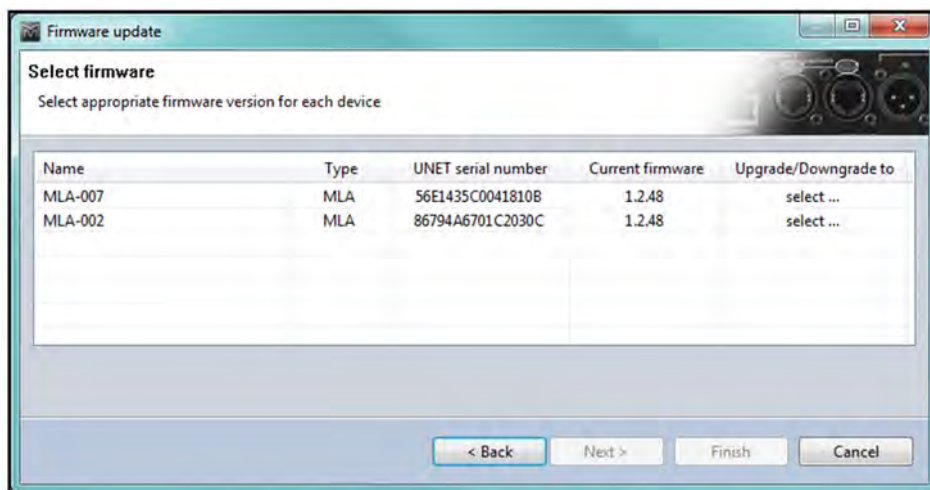

The current firmware is shown and the final column has an option to select the required firmware which in most cases would be a new version but could be an old firmware if say a bug has been found in a current version and it is necessary to downgrade to an earlier version. If there are several versions available, clicking on the Upgrade/Downgrade cell will bring up a drop-down showing the version numbers. Select the version you wish to use and it will appear in the final column; -

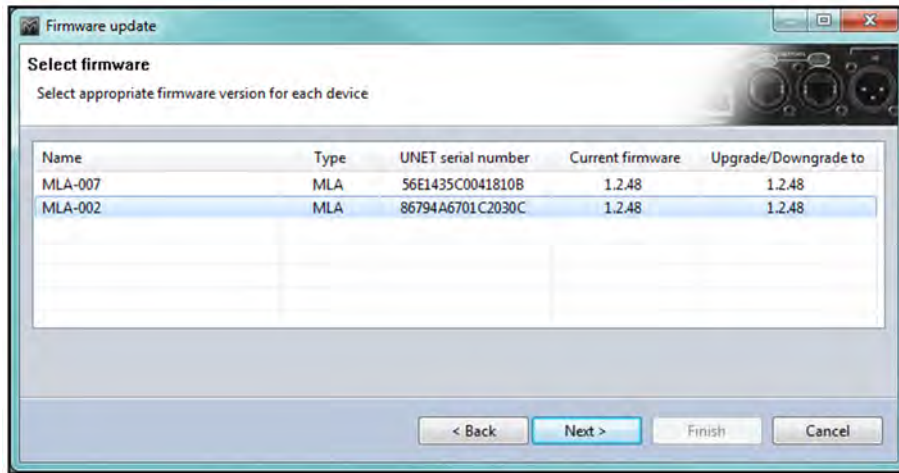

Click on 'Next' to start the update. You will first see the following warning to ensure that every measure has been taken to ensure that the update will complete successfully; -

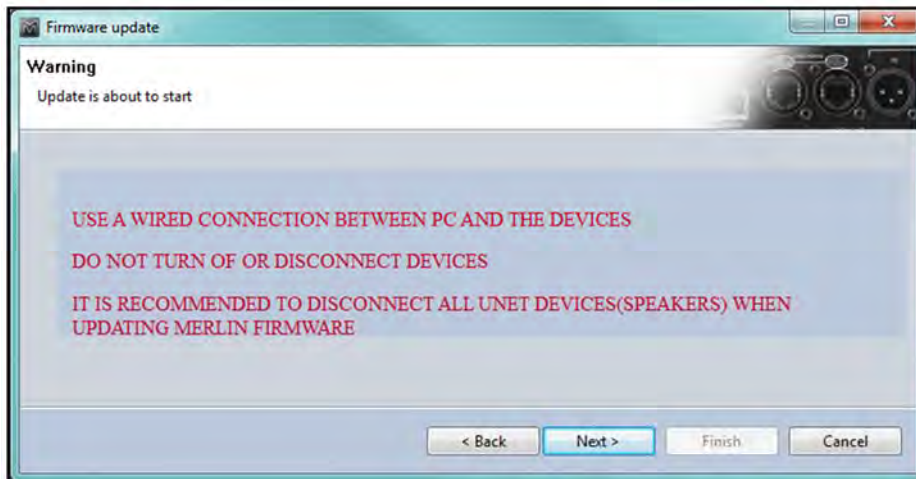

Click 'Next' and the upgrade will start. A progress window will appear showing the processes in the upgrade taking place. The system tackles one device at a time, placing it into Boot Mode, uploading the firmware and rebooting the device back into an operating mode; -

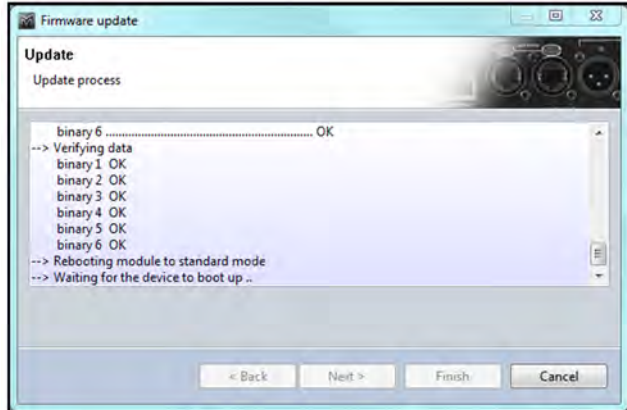
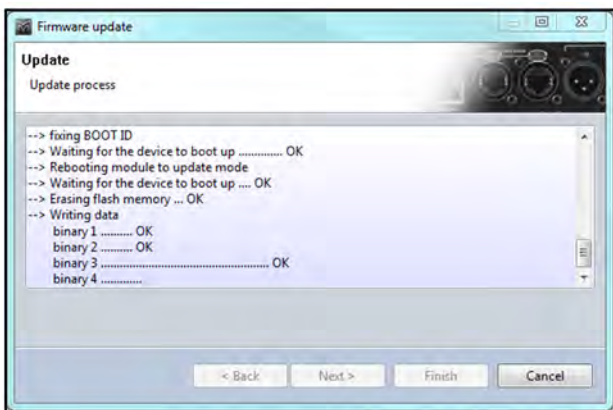
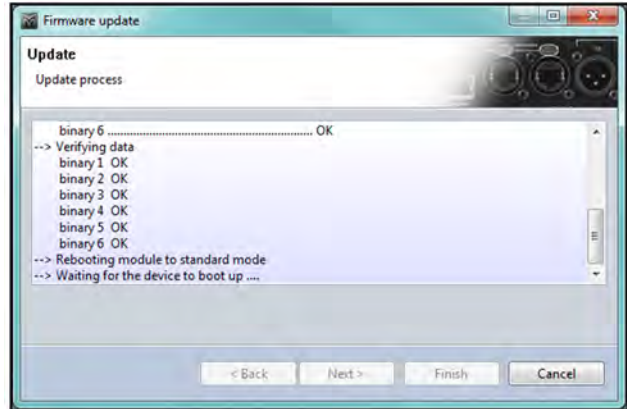
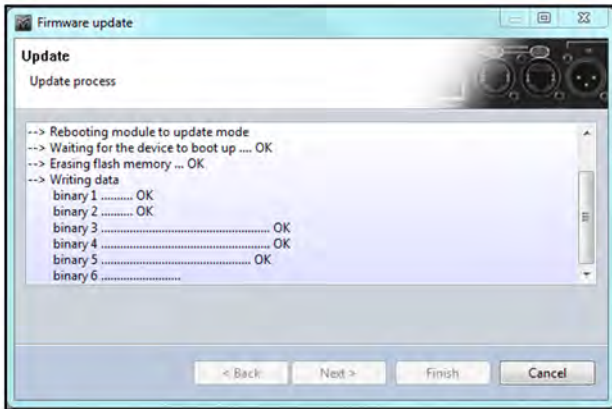

Once completed you will see the following; -

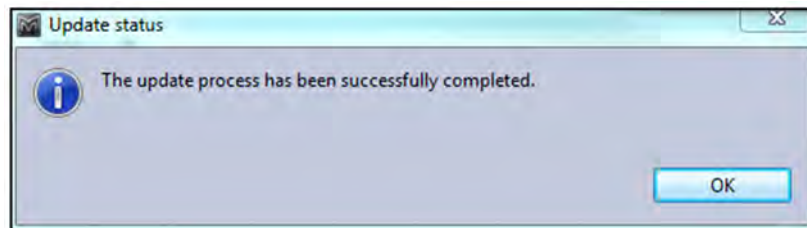

Click 'OK' and then click on 'Finish' on the Update Progress Window. The update is complete.

**Important:** Be aware that a firmware update will leave the cabinet in factory default mode once complete. The Input will be set to analogue and any presets or EQ applied to the cabinets will be lost so will have to be re-uploaded.

## MLA/MLD Conversion Tool

The MLA and MLD use identical amplifier modules but require different firmware to be installed for correct operation. This utility function is fairly obviously best performed back in the warehouse when a system is prepped but may be necessary in an emergency if a module fails in an MLA and the only spare module is an MLD or vice versa. As with a Firmware upgrade, the process involves placing a cabinet into Boot Mode, deleting the currently installed Firmware and re-flashing the module with new Firmware. Whilst a conversion is taking place the module is in just as venerable a state as for a firmware upgrade so exactly the same precautions need to be taken. Make absolutely certain that the mains feed will not be interrupted. Use a hard-wired network connection and make sure that you have minimised the possibility of any cables being disconnected.

To use the tool your Vu-Net project cannot have any devices already in the System Diagram so either delete all devices (making sure you save your project first) or better still start a new project. Select the MLA/MLD Conversion tool from the Tools menu, you will see an 'Operation in progress' window while Vu-Net scans the U-Net network for all connected MLA or MLD in a similar way to a Device Discovery; -

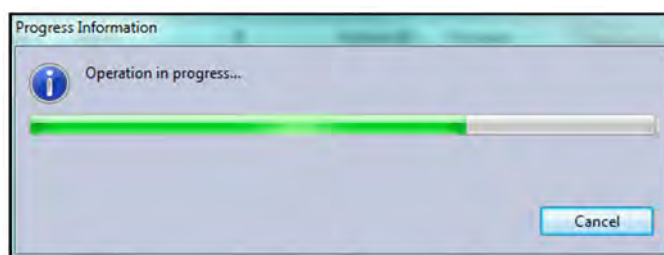

The following Window will appear once the scan is completed; -

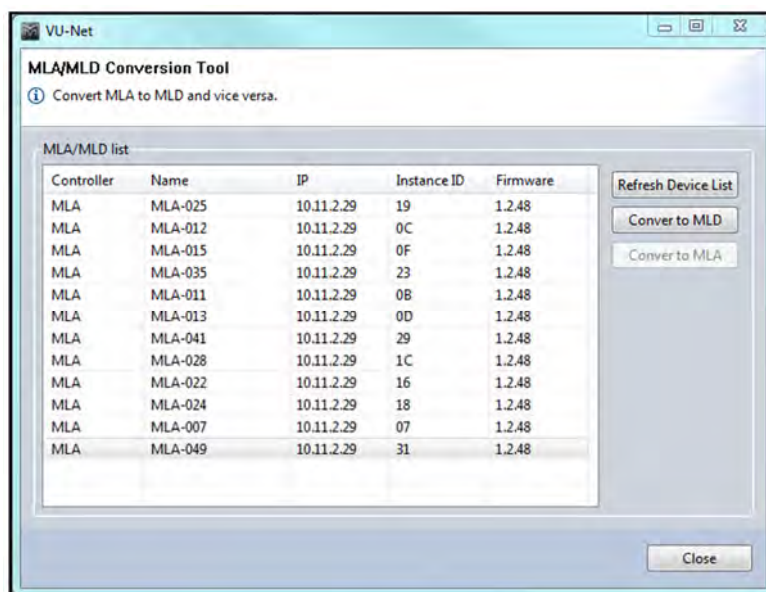

All devices will be listed showing their unique name the network IP and ID plus the firmware presently installed. Click on the cabinet you wish to convert, the Conversion Tool can only change one cabinet at a time although it is unlikely you will need to do more than one in most situations. If you select an MLA you will have the option to convert to MLD and vice versa. In this example we will convert the last MLA in the list (MLA-049) to an MLD. Once the box is selected click 'Convert to MLD'. You will see a window asking you to confirm which Firmware version you would like to use. Generally there will not be a choice but if there are still older firmware versions installed you have the option to down-grade to the older version; -

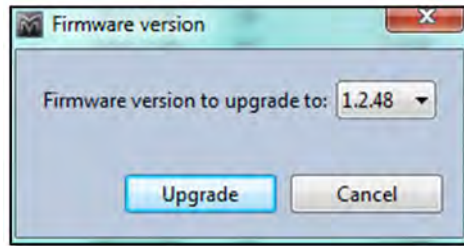

Once you have selected the firmware click on 'Upgrade', you will see a window which shows the progress of the firmware conversion; -

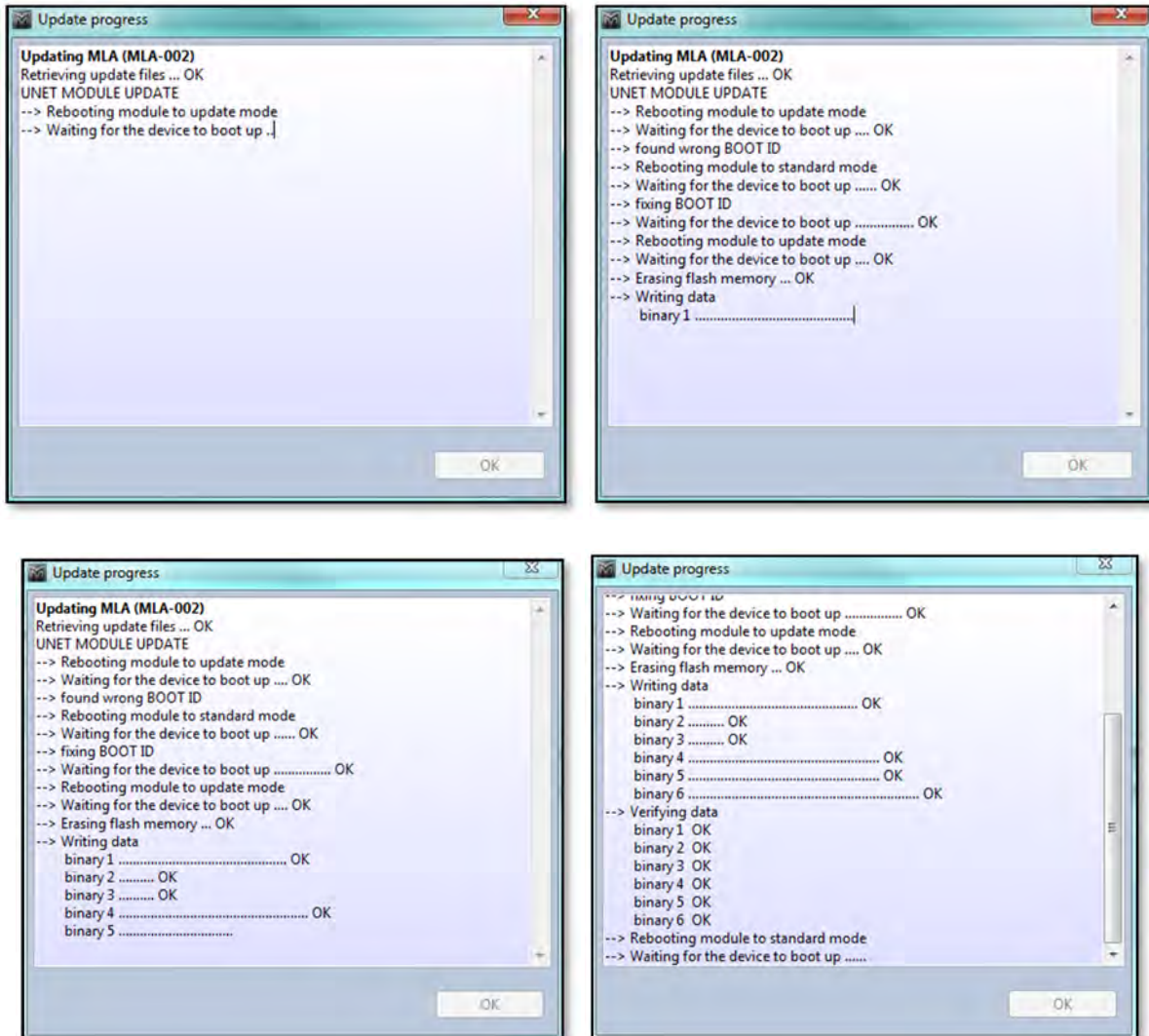

When the conversion is finished you will see a confirmation window; -

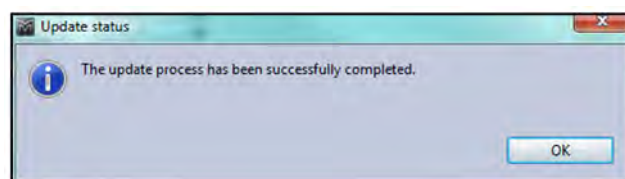

Click 'OK' and close the update progress monitor. Vu-Net will then re-scan U-Net to check all connected devices; -



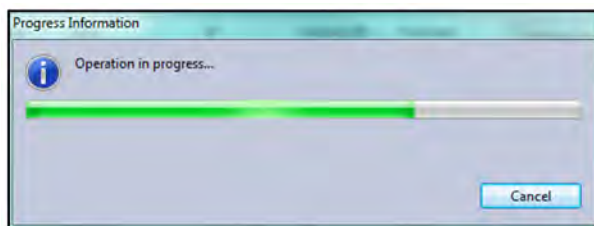

You will then see the same Window as previously showing all connected devices, note how the last enclosure in the list is now an MLD; -

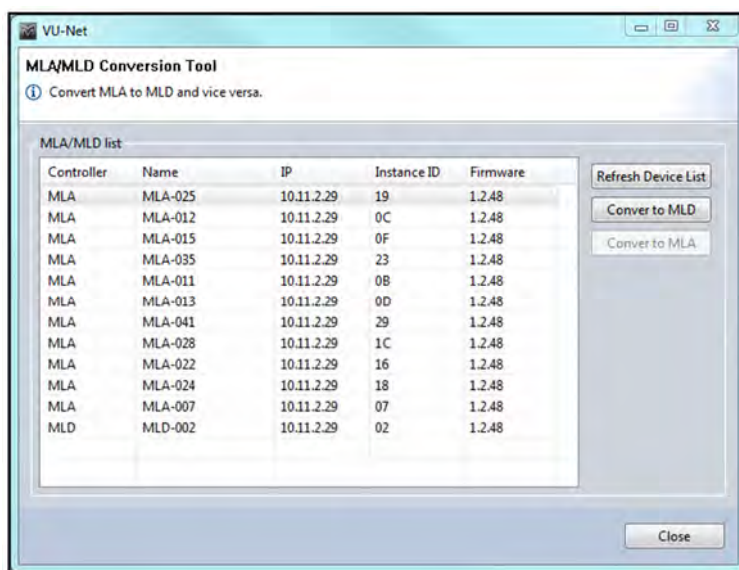

The window can be closed and a system discovered and used in the normal way.

**Martin Audio Limited**

Century Point

Halifax Road

Cressex Business Park

High Wycombe

Buckinghamshire

HP12 3SL

England

**FOR SALES ENQUIRIES:**

**UK**

Telephone: +44 (0)1494 535312

E-mail: [info@martin-audio.com](mailto:info@martin-audio.com)

**NORTH AMERICA**

Telephone: 323-381-5310

**[www.martin-audio.com](http://www.martin-audio.com)**

All information is Copyright © 2020 Martin Audio Ltd.

Martin Audio, the Martin Audio logo and Hybrid are registered trademarks of Martin Audio Ltd. in the United Kingdom, United States and other countries; all other Martin Audio trademarks are the property of Martin Audio Ltd.

